



**Map3D User's  
Manual**

# Map3D Version 65

User's Manual

---

*by Map3D International Ltd*

# Map3D User's Manual

## Map3D International Ltd 1990-2017

All rights reserved. No parts of this work may be reproduced in any form or by any means - graphic, electronic, or mechanical, including photocopying, recording, taping, or information storage and retrieval systems - without the written permission of the publisher.

Products that are referred to in this document may be either trademarks and/or registered trademarks of the respective owners. The publisher and the author make no claim to these trademarks.

While every precaution has been taken in the preparation of this document, the publisher and the author assume no responsibility for errors or omissions, or for damages resulting from the use of information contained in this document or from the use of programs and source code that may accompany it. In no event shall the publisher and the author be liable for any loss of profit or any other commercial damage caused or alleged to have been caused directly or indirectly by this document.

Printed: January 2017.

### **Publisher**

*Map3D International Ltd*  
*Email: [support@map3d.com](mailto:support@map3d.com)*  
*Web: [map3d.com](http://map3d.com)*  
*Tel: 1 647 729 7572*

# Table of Contents

Foreword	0
<b>Part I Map3D Overview</b>	<b>2</b>
1 Introduction .....	2
2 About Map3D .....	2
3 Map3D Overview .....	11
4 Applications .....	12
5 Model Building Overview .....	13
6 Boundary Element Formulation .....	14
7 Rock Mass Response Predictions Using Numerical Modelling .....	16
8 Implementation of Modelling into the Mine Design Process .....	23
<b>Part II Model Building and Editing</b>	<b>27</b>
1 Model Building and Editing .....	27
2 Building Surface Models .....	27
3 Building Models out of Blocks .....	29
4 Constructing Alternate Material Zones .....	30
5 Material Codes - Mining Step Sequence .....	33
6 Defining Ground Surface .....	35
7 Defining Open Pits .....	35
8 Defining Fault Planes and Tabular Mining Zones .....	36
9 Defining Inactive Blocks for Visualization Purposes .....	39
10 Common Problems When Model Building .....	39
11 Discretization and Lumping .....	44
<b>Part III Model Building Tutorials</b>	<b>54</b>
1 Freehand Sketching - Room and Pillar Mining .....	54
2 Bulk Mining Example .....	76
3 Tabular Mining Example .....	96
4 DDLoop Pillar Example .....	120
5 FFLoop Drift Example .....	125
6 FFLoop Stope Example .....	129
<b>Part IV Menu Commands</b>	<b>134</b>

<b>1 File Menu .....</b>	<b>134</b>
<b>New Model (CAD) .....</b>	<b>134</b>
<b>Quick Open (View Only) .....</b>	<b>134</b>
<b>Open Model (CAD) .....</b>	<b>134</b>
<b>Save Model (CAD) .....</b>	<b>135</b>
<b>Save Model As (CAD) .....</b>	<b>135</b>
<b>Import model from DXF or PNT .....</b>	<b>136</b>
<b>Export model as DXF or PNT .....</b>	<b>137</b>
<b>Restore last CAD State .....</b>	<b>137</b>
<b>New Construction Lines .....</b>	<b>137</b>
<b>Quick Open Construciton Lines (View only) .....</b>	<b>137</b>
<b>Open Construction Lines .....</b>	<b>138</b>
<b>Save Construction Lines .....</b>	<b>139</b>
<b>Save Construction Lines As .....</b>	<b>139</b>
<b>Open Analysis Results .....</b>	<b>139</b>
<b>Subtract Restart Files .....</b>	<b>140</b>
<b>Restart an Analysis .....</b>	<b>140</b>
<b>Update Restart Files .....</b>	<b>140</b>
<b>Mining Step # .....</b>	<b>141</b>
<b>Output .....</b>	<b>141</b>
Copy Screen to Clipboard.....	141
Copy Screen (B&W flipped).....	141
PNG, GIF, JPEG, BMP or TIFF Screen Image.....	142
PNG, GIF, JPEG, BMP or TIFF (B&W flipped).....	142
DXF Screen Image.....	142
PNT Screen Image.....	143
OBJ Screen Image.....	143
WRL Screen Image.....	143
3D-PDF Screen Image.....	143
Selected Grid Components.....	143
Selected Surface Components .....	147
Animated TIFF/GIF Recorder.....	150
Image Recorder .....	150
<b>Image Viewer .....</b>	<b>151</b>
<b>Save View .....</b>	<b>152</b>
<b>Restore View .....</b>	<b>152</b>
<b>Recent Files .....</b>	<b>152</b>
<b>Exit .....</b>	<b>152</b>
<b>2 View Menu .....</b>	<b>152</b>
<b>Hide .....</b>	<b>152</b>
Off .....	152
Surfaces .....	152
Blocks .....	152
Colour Numbers .....	152
Colours (1-10) .....	152
Materials .....	152
Names .....	152
Mining Steps .....	152
Window .....	152

Crossing	152
Undo last Hide	152
Redo last Hide	152
Unhide All	152
Inactive	152
Solids	152
Excavations	152
Unused	152
Translucent	152
Errors	152
<b>Hide Block Colours</b>	<b>155</b>
Hide All	155
Unhide All	155
Colour 1	155
Colour 2	155
Colour 3	155
Colour 4	155
Colour 5	155
Colour 6	155
Colour 7	155
Colour 8	155
Colour 9	155
Colour 10	155
<b>Hide Cline Colours</b>	<b>155</b>
Hide All	155
Unhide All	155
Colour 1	155
Colour 2	155
Colour 3	155
Colour 4	155
Colour 5	155
Colour 8	155
Colour 9	155
Colour 10	155
<b>Hide Grid Colours</b>	<b>156</b>
Hide All	156
Unhide All	156
Colour 1	156
Colour 2	156
Colour 3	156
Colour 4	156
Colour 5	156
Colour 6	156
Colour 7	156
Colour 8	156
Colour 9	156
Colour 10	156
<b>Render</b>	<b>156</b>
Block Outlines	156
Grid Lines	156

Block Colours .....	156
Material Numbers .....	156
Mining Step Numbers .....	156
Dark Shading .....	156
Bright Shading .....	156
Texture Rendering.....	156
Assign Block Textures.....	157
Small Block Numbers.....	158
Large Block Numbers.....	158
Small Block Names.....	158
Large Block Names.....	158
Small Coordinate Numbers.....	158
Large Coordinate Numbers.....	158
Backfacing Surfaces.....	158
Fixed width spacing.....	158
Discretize .....	158
Perspective .....	158
Cline dot radius .....	158
Point Size .....	158
Line Width .....	158
<b>Find Coordinate .....</b>	<b>159</b>
<b>Initialize .....</b>	<b>159</b>
<b>Zoom Extents .....</b>	<b>159</b>
<b>Zoom .....</b>	<b>160</b>
<b>Pan .....</b>	<b>160</b>
<b>Length .....</b>	<b>160</b>
<b>Centre of Rotation .....</b>	<b>160</b>
<b>Translation Increment .....</b>	<b>160</b>
<b>Rotation Increment .....</b>	<b>161</b>
<b>Zoom Factor .....</b>	<b>161</b>
<b>View XY plane .....</b>	<b>161</b>
<b>View YZ plane .....</b>	<b>161</b>
<b>View ZX plane .....</b>	<b>161</b>
<b>View Grid plane .....</b>	<b>161</b>
<b>View Digitizer plane .....</b>	<b>161</b>
<b>View 640x480 .....</b>	<b>162</b>
<b>Continuous Rotation .....</b>	<b>162</b>
<b>3 Plot Menu .....</b>	<b>162</b>
<b>Stress .....</b>	<b>162</b>
Major Principal Stress.....	162
Intermediate Principal Stress.....	162
Minor Principal Stress.....	162
Maximum Shear Stress.....	163
In-Plane Shear Stress.....	164
In-Plane Normal Stress.....	164
In-Plane Maximum Stress.....	165
In-Plane Minimum Stress.....	165
Ubiquitous-Plane Shear Stress.....	166
Ubiquitous-Plane Normal Stress.....	166
Ubiquitous-Plane Maximum Stress.....	167

Ubiquitous-Plane Minimum Stress.....	167
Octahedral Shear Stress.....	168
Mean Stress .....	168
Sxx Cartesian Stress.....	169
Syy Cartesian Stress.....	169
Szz Cartesian Stress.....	169
Txy Cartesian Stress.....	169
Txz Cartesian Stress.....	169
Tyz Cartesian Stress.....	169
Value .....	169
Effective stress .....	169
Total stress .....	169
Induced Stress .....	170
Absolute Stress .....	170
<b>Strain .....</b>	<b>170</b>
Major Principal Strain.....	170
Intermediate Principal Strain.....	170
Minor Principal Strain.....	170
Maximum Shear Strain.....	171
In-Plane Shear Strain.....	171
In-Plane Normal Strain.....	171
In-Plane Maximum Strain.....	173
In-Plane Minimum Strain.....	173
Ubiquitous-Plane Shear Strain.....	174
Ubiquitous-Plane Normal Strain.....	174
Ubiquitous-Plane Maximum Strain.....	175
Ubiquitous-Plane Minimum Strain.....	175
Octahedral Shear Strain.....	176
Volumetric Strain .....	176
Exx Strain Component.....	177
Eyy Strain Component.....	177
Ezz Strain Component.....	177
Exy Strain Component.....	177
Eyz Strain Component.....	177
Exz Strain Component.....	177
Value .....	178
Elastic strain .....	178
Plastic Strain .....	178
Total Strain .....	178
Induced Strain .....	178
Absolute Strain .....	178
Strain .....	178
Milli-Strain .....	178
Micro-Strain .....	178
<b>Displacement .....</b>	<b>178</b>
Total displacement.....	178
X displacement .....	178
Y displacement .....	178
Z displacement .....	178
In-plane normal displacement.....	178



In-plane maximum displacement..... 178

Ubiquitous-plane normal displacement..... 178

Ubiquitous-plane maximum displacement..... 178

**User defined plot ..... 180**

**Thermal/Flux ..... 183**

Plot > Thermal/Flux..... 183

Total flux ..... 183

X flux ..... 183

Y flux ..... 183

Z flux ..... 183

In-plane normal flux..... 183

In-plane maximum flux..... 183

Ubiquitous-plane normal flux..... 183

Ubiquitous-plane maximum flux..... 183

**Strength Factors ..... 185**

Rock Mass Parameters..... 185

    Rockmass Strength Parameters..... 185

    Accumulated Damage..... 189

    S1 Excess Stress ..... 189

    Tmax Excess Stress..... 191

    Toct Excess Stress..... 191

    NS1 Normal Probability..... 194

    SF-A Strength/Stress ..... 194

    SF-B Strength/Stress ..... 195

    SF-C Strength/Stress..... 197

    SF/A Stress/Strength..... 200

    SF/B Stress/Strength..... 202

    SF/C Stress/Strength..... 204

In-Plane Parameters..... 207

    In-plane parameters..... 207

    Accumulated Damage..... 208

    In-plane Excess Shear Stress..... 209

    In-plane Excess Wall Stress..... 210

    RCPIP Rock Wall Condition Factor..... 210

    NTip Normal Probability..... 211

    SF-ip Strength/Stress..... 211

    SF/ip Stress/Strength..... 211

UB-Plane Parameters ..... 213

    Ubiquitous parameters..... 213

    Accumulated Damage..... 216

    Ubiquitous Excess Shear Stress..... 216

    Ubiquitous Plane Excess Wall Stress ..... 218

    RCFub Rock Wall Condition Factor..... 218

    NTub Normal Probability..... 219

    SF-ub Strength/Stress..... 219

    SF/ub Stress/Strength..... 219

    UB# ..... 219

**Surface Components ..... 221**

Surface Contours Off..... 221

Serr Stress error ..... 221

Ferr Failure error .....	221
Shear stress .....	222
Normal stress .....	222
Shear strain .....	223
Accumulated strain.....	223
Normal strain .....	223
Shear Displacement (Ride).....	224
Normal Displacement (Closure).....	224
ERR .....	225
SF-D Strength/Stress.....	229
Excess Shear Stress.....	230
Incremental Shear Strain.....	231
Stress/Strain rate .....	232
Cohesion .....	232
Phi .....	232
Temperature/Head.....	232
Normal Flux .....	233
Value .....	233
Elastic strain .....	233
Plastic Strain .....	233
Total Strain .....	233
Absolute Strain .....	233
Induced Strain .....	233
Induced Stress .....	234
Absolute Stress .....	234
<b>Miscellaneous .....</b>	<b>234</b>
Delem Distance to nearest element on surfaces.....	234
Dgrid Distance to nearest grid on surfaces.....	234
Delem/Lelem DON ratio on surfaces.....	235
Dgrid/Lelem DOL ratio on surfaces.....	235
Dratio on surfaces.....	235
Dgrid Distance to nearest element on grids.....	235
Dgrid/Lgrid DOL ratio on grids.....	236
Matl# - Material Number on Grids.....	236
<b>Contour Range .....</b>	<b>236</b>
<b>Grid Selection .....</b>	<b>237</b>
<b>Plot Options .....</b>	<b>237</b>
<b>Properties .....</b>	<b>241</b>
Control Parameters.....	241
Mining Step Titles.....	245
Material Properties.....	245
Map3Di Setup .....	246
Model Information .....	249
<b>Average Box .....</b>	<b>249</b>
<b>Polygon Box .....</b>	<b>249</b>
<b>Excel Plot (Grids) .....</b>	<b>250</b>
<b>Excel Plot (Surfaces) .....</b>	<b>254</b>
<b>4 Analysis .....</b>	<b>257</b>
<b>Analysis .....</b>	<b>257</b>
<b>Analysis Options .....</b>	<b>258</b>

<b>5 CAD</b>	<b>260</b>
<b>Build</b>	<b>260</b>
Block	260
FF Loop	263
DD Loop	269
Grid Plane	276
Grid Line	277
Construction Lines	279
Build	280
Enter Point	281
Extrude/Offset Remaining	281
Undo Point	283
Redo Point	283
Undo Build	284
Redo Build	284
<b>Snap</b>	<b>285</b>
None	285
Nearest Edge	285
Nearest Corner	285
Nearest Surface	286
Midpoint of Line	286
Tangent Snap	286
Intersection Snap	287
Trace Virtual Line Snap	288
Trace Cline Snap	288
Trace Cloop Snap	289
Rectangular Grid Snap	289
Circular Grid Snap	290
X-Grid Snap	290
Y-Grid Snap	291
Z-Grid Snap	291
Cursor/Grid Setup	292
XY Cursor	292
YZ Cursor	292
XZ Cursor	292
User defined coordinate system	292
<b>Properties</b>	<b>294</b>
Control Parameters	294
Mining Step Titles	298
Material Properties	298
Map3Di Setup	299
Model Information	301
<b>Edit</b>	<b>302</b>
Entity Properties	302
Erase Entities	306
Move Entities	306
Copy Entities	308
Scale Entities	309
Rotate Azimuth	311
Rotate Dip	313

Dump to File .....	315
Group Entities .....	315
Stretch Verticies .....	317
Move Verticies to point.....	318
Move Verticies to X.....	320
Move Verticies to Y.....	321
Move Verticies to Z.....	322
Move Verticies to Plane.....	324
Subdivide Edges .....	326
Smooth Construction Lines.....	327
Remove Construction Line Vertex.....	329
<b>Grid Selection .....</b>	<b>330</b>
<b>Digitizer Setup .....</b>	<b>331</b>
<b>Resequence Block Links .....</b>	<b>331</b>
<b>Recheck Blocks for Errors .....</b>	<b>332</b>
<b>Pack and Renumber Blocks .....</b>	<b>332</b>
<b>Unpack Blocks .....</b>	<b>332</b>
<b>Unpack Surfaces .....</b>	<b>332</b>
<b>UnGroup DDs .....</b>	<b>333</b>
<b>Pack and Renumber Clines .....</b>	<b>333</b>
<b>Unpack Clines .....</b>	<b>334</b>
<b>6 Tools .....</b>	<b>334</b>
<b>Mouse Options .....</b>	<b>334</b>
Mouse Buttons .....	334
Double Click Time.....	335
Drag Wait Time .....	335
<b>Toolbars .....</b>	<b>335</b>
Rotation Toolbar .....	335
Translation Toolbar.....	336
Contour Toolbar .....	336
Configure Contour Toolbar.....	337
Solve Toolbar .....	337
Configure Solve Toolbar.....	338
View Toolbar .....	338
Configure View Toolbar.....	339
CAD Toolbar .....	339
Configure CAD Toolbar.....	340
Block Colours .....	340
Contour Colours .....	341
Set Default Block Colours.....	342
Set Contour Colours 1.....	342
Set Contour Colours 2.....	342
Set Contour Colours 3.....	342
Set Contour Colours 4.....	342
Configure Button Font.....	342
Reset Default Font.....	343
Small Size Buttons.....	343
Medium Size Buttons.....	343
Large Size Buttons.....	343
XL Size Buttons .....	343

XXL Size Buttons .....	343
<b>Assign Hotkeys .....</b>	<b>343</b>
<b>OpenGL .....</b>	<b>343</b>
OpenGL <On/Off>.....	343
OpenGL Parameters.....	344
OpenGL Antialiasing.....	344
OpenGL Redraw .....	344
OpenGL Pick .....	344
OpenGL Crosshairs.....	344
OpenGL Interactive Edit.....	345
<b>Disk Performance Test .....</b>	<b>345</b>
<b>Smooth Scroll .....</b>	<b>345</b>
<b>Cursor Pick Box Size .....</b>	<b>346</b>
Small Pick Box .....	346
Medium Pick Box .....	346
Large Pick Box .....	346
<b>7 Shift-key Selection .....</b>	<b>346</b>
<b>8 Crosshairs .....</b>	<b>346</b>
<b>9 Visualization .....</b>	<b>346</b>
Visualization (of text files) .....	346
Visualization (of EVP files) .....	349
Visualization Database .....	353
Contour Plane Options .....	354
Plot .....	357
<b>10 Help .....</b>	<b>357</b>
Contents and Index .....	357
What's This? .....	357
Web: <a href="http://www.map3d.com">www.map3d.com</a> .....	358
Email: <a href="mailto:support@map3d.com">support@map3d.com</a> .....	358
Email: Key check to <a href="mailto:support@map3d.com">support@map3d.com</a> .....	358
Download: Map3D update (setup.exe) .....	358
Download: Map3D update (Map3D.zip) .....	358
Download: HTML User's Manual .....	359
Download: PDF User's Manual .....	359
Download Ebook User's Manual .....	359
About Map3D .....	360

## **Part V Appendix 362**

<b>1 Analysis .....</b>	<b>362</b>
Analysis > Options > MSCALC Output File Name .....	362
Analysis > Abort .....	362
Analysis > Auto Plot .....	362
Analysis > Auto Range .....	362
Analysis > BEM Analysis .....	363
Analysis > Discretization .....	363
Analysis > Go to CAD .....	364
Analysis > Go to Results .....	364
Analysis > View Results .....	364

Analysis > Intersections .....	365
Analysis > Load Model .....	365
Analysis > Minimize .....	365
Analysis > Options > Accelerator .....	366
Analysis > Options > Async I/O .....	366
Analysis > Options > Auto Repair .....	366
Analysis > Options > Batch .....	367
Analysis > Options > CGM .....	367
Analysis > Options > Closure .....	368
Analysis > Options > Collinearity .....	368
Analysis > Options > Collinearity Search Radius .....	369
Analysis > Options > Collapse .....	369
Analysis > Options > Creep .....	369
Analysis > Options > #C/T .....	370
Analysis > Options > Drive # .....	371
Analysis > Options > Move Points .....	373
Analysis > Options > MSCALC .....	373
Analysis > Options > Initialization .....	376
Analysis > Options > Initialization file name .....	376
Analysis > Options > LERD/LSS .....	376
Analysis > Options > LERD/LSS file name .....	380
Analysis > Options > Linear .....	380
Analysis > Options > Lumping .....	381
Analysis > Options > Lumping Accuracy .....	381
Analysis > Options > Planar .....	382
Analysis > Options > P-ram .....	382
Analysis > Options > Precondition .....	383
Analysis > Options > Renumber .....	383
Analysis > Options > Reset .....	384
Analysis > Options > V-ram .....	384
Analysis > Options > Verbose .....	384
Analysis > Options > Zero Strain Placement .....	384
Analysis > Suspend .....	385
Analysis > Conclude .....	385
Analysis > Disable .....	386
Analysis Dialog .....	387
<b>2 CAD .....</b>	<b>388</b>
CAD > Properties > Map3Di Setup > View .....	388
CAD > Build > Block Mesh Spacing .....	389
CAD > Snap .....	390
CAD > Edit .....	390
CAD > Edit > Entity Properties > DDPlane Thickness .....	391
CAD > Edit > Entities .....	391
CAD > Edit > Entities .....	393
CAD > Edit > Build A List of Entities for Editing .....	394
CAD > Edit > Build A List of Verticies for Editing .....	395
CAD > Digitizer > Activate .....	396
CAD > Properties > Material Properties > Stress State .....	397
CAD > Properties > Material Properties > Stress State > Cartesian .....	399
CAD > Properties > Material Properties > Stress State > Datum .....	400

CAD > Build .....	400
<b>3 File .....</b>	<b>401</b>
File > Open > Merge Materials .....	401
File > Output > Animated GIF Recorder > Append Images .....	401
File > PNT Output File Format .....	401
File > PNT Construction Line File Format .....	402
File > PNT Model File Format .....	402
File > Restart File Formats .....	404
File > Construction Line File Formats .....	404
File > DXF Construction Line File Format .....	404
File > DXF Model File Format .....	404
File > INP Model File Format .....	408
File > Open > Recent Directories .....	417
File > Open > Merge Geometries .....	418
File > Model File Formats .....	418
<b>4 Materials .....</b>	<b>419</b>
Materials > Mohr-Coulomb in 3D FF Blocks .....	419
Materials > Hoek-Brown in 3D FF Blocks .....	424
Materials > Drucker-Prager in 3D FF Blocks .....	426
Materials > Fault-Gouge in DD Planes .....	428
Materials > Hyperbolic-Backfill in DD Planes .....	433
Materials > Quadratic-Backfill in DD Planes .....	437
Materials > Equilibrated-Gouge in DD Planes .....	442
Materials > Yielding-Pillar in DD Planes .....	448
Materials > User Defined Parameters .....	453
Materials > Dump to File .....	453
Materials > Expansion Coefficient and Conductivity .....	453
<b>5 Dock the View Toolbar .....</b>	<b>454</b>
<b>6 Dock the Contour Toolbar .....</b>	<b>454</b>
<b>7 Map3D Analysis Stages .....</b>	<b>454</b>
<b>8 Map3D Versions .....</b>	<b>455</b>
<b>9 Map3D Fault-Slip .....</b>	<b>458</b>
<b>10 Map3D Modeller .....</b>	<b>459</b>
<b>11 Map3D Results Viewer .....</b>	<b>461</b>
<b>12 Map3Di Integrated Seismicity .....</b>	<b>462</b>
<b>13 Map3D Thermal-Fluid Flow .....</b>	<b>465</b>
<b>14 Map3D Non-Linear .....</b>	<b>466</b>
<b>15 Map3D Visco-Plastic .....</b>	<b>467</b>
<b>16 Model Building Tutorials .....</b>	<b>472</b>
<b>17 Plot &gt; Stress .....</b>	<b>473</b>
<b>18 Plot &gt; Failure Modes .....</b>	<b>473</b>
<b>19 Plot &gt; Strain .....</b>	<b>475</b>
<b>20 Plot &gt; Surface Components .....</b>	<b>476</b>

21	Stress Orientation Icon .....	477
22	Translating the Model .....	477
23	View > Render > Discretize .....	478
24	Visualization > Make Point .....	478
25	Global Transform Z+ up .....	479
26	Global Transform Z- up_2 .....	480
	<b>Index</b>	<b>482</b>



**Map3D  
User's Manual**

**Part**

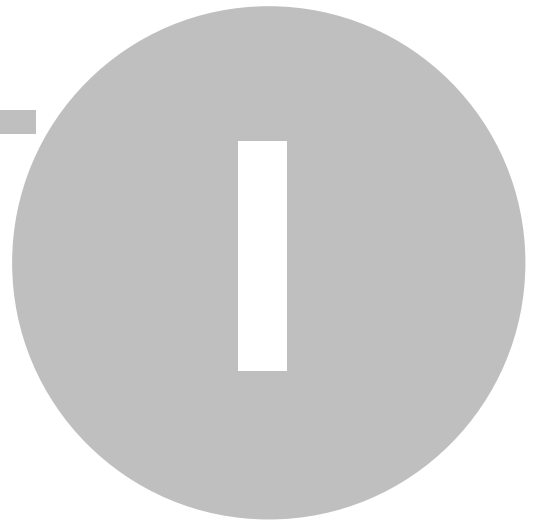

# 1 Map3D Overview

## 1.1 Introduction

Map3D is a fully integrated three-dimensional layout (CAD), visualization (GIS) and stability analysis package (BEM stress analysis). Various program modules ([Map3D Versions](#)) can be used to construct models, analyze and display stresses, strains, displacements, strength factors and probability of failure contours. Map3D is suitable for building and modelling rock and soil engineering design problems involving both irregular 3D massive excavations, tunnels, faults and tabular shapes.

Models can include underground excavations, rock slopes, open pits, tunnels, fractures and surface infrastructure loads. The stress analysis models can simulate yielding (non-linear) zones of different moduli (e.g. stiff dykes or soft ore zones) and loads due to steady state thermal/fluid flow. Excavations can be intersected by multiple discrete faults (non-planar and gouge filled) that slip and open. Map3D can simulate ground support elements such as arches, steel sets, props, thick liners, chinks, backfill etc.

The program is designed for fast, easy building and visualization of 3D models:

- Self-contained 3D CAD system for model construction
- Integrated GIS for storing, analyzing and displaying geographical reference information
- Advanced boundary element (BEM) stress analysis

Map3D is suitable for mining, geotechnical and civil engineering applications.

What sets Map3D apart from other analysis programs is its ability to accommodate a very wide range of problems in 3D. Large, complex, fully 3D problems can be built with ease using the built-in CAD functionality. Combined use of both FF and DD elements allows for simulations of 3D excavations with intersecting fractures or shear planes.

Powerful pre-processing capabilities automatically fix most model construction problems. Overlapping and intersecting surfaces are accommodated by the program without user intervention. Model discretization can be optimized by setting a few control parameters to automatically concentrate elements at locations of interest. These capabilities greatly ease the burden of model building letting you get on with engineering rather than spending your time debugging models.

[Map3D Overview](#)

## 1.2 About Map3D

Map3D is developed and supported by Dr. Terry Wiles ([support@map3d.com](mailto:support@map3d.com)) of Map3D International Ltd. Development of Map3D began in the late 1970's and has gone through many major revisions since then. It has been commercially available since 1990. The program is constantly under development and supported by dedicated professionals who have been in the rock mechanics/numerical modelling business for over 40 years.

The program is used by hundreds of mining, civil and geotechnical companies, consultants, research centres and universities around the world (including Argentina, Armenia, Australia, Austria, Belgium, Botswana, Brazil, Bulgaria, Canada, Chile, China, Columbia, Democratic Republic of Congo, Egypt, El Salvador, England, Finland, Ghana, Greece, Guatemala, India, Indonesia, Ireland, Italy, Japan, Kazakhstan, Korea, Mali, Mexico, Morocco, Mongolia, Namibia, Nedlands, Nicaragua, Papua New Guinea, Peru, Philippines, Saudi Arabia, South Africa, Spain, Sweden, Switzerland, Tanzania,

Turkey, UK, USA, Zambia and Zimbabwe). Map3D is often specified as a prerequisite for employment on job advertisements. The [demo version](#) is used worldwide for teaching students the fundamentals of numerical modelling and 3D CAD.

It has been used in many projects including underground and open pit mine design, mine stability assessment, nuclear waste repository design, fracture propagation simulations, fault slip problems, in situ stress back-analysis, rock quarry design, open-pit wall stability, hydraulic-fracture propagation, earth slope failures, etc.. Current research and development is focusing on quantitative design procedures, 3D plastic modelling, ground support simulation, the capability to assess the potential for rock bursting, simulation of discing and integration of modelling with seismic monitoring.

**Boundary Element Method** - Map3D is formulated using the very efficient Indirect Boundary Element Method and incorporates simultaneous use of fictitious force (FF), displacement discontinuity (DD) and special proprietary boundary elements incorporated for the thermal, non-linear and visco-plastic analysis versions ([Map3D Versions](#)).

Research and development over the past 40 years has allowed many of the supposed limitations of the boundary element method to be overcome. The program can accommodate multi-step mining sequences, multiple material zones with different material properties and stress states, and discontinuous rock response with a limited number of discrete features. Both 3D zones and DD zones are permitted to behave non-linearly and/or plastically. Multiple intersecting fault planes can slip and open according to user specified shear strength. Coupled steady state thermal/fluid stress analysis can be simulated. Real time creep and relaxation problems can be accommodated using explicit time stepping.

**Elastic vs Plastic Modelling** - Proponents of plastic modelling often claim unique capabilities over elastic modelling such as:

- Ability to predict magnitude, location, timing, orientation of damage.
- Ability to simulate stress redistribution due to yielding.
- Ability to track accumulated damage with advancing mining.

Although Map3D can analyse full 3D rock mass plasticity, it can also address all of these supposed unique plastic capabilities using elastic modelling.

This is possible due to new analysis tools that have been incorporated into the program::

- Map3D elastic models are fully capable of predicting the magnitude, location, timing, orientation of damage through calculation of excess stress.
- Three major failure modes can be assessed:
  - Rock mass failure.
  - In-plane fault type failure.
  - UB-plane structurally oriented weakness (with up to 3 joint sets).
- Stress redistribution can be simulated by incorporating softened zones.
- There is new functionality to track accumulated damage (excess stress) in elastic models:
  - Damage is tracked with advancing mining.
  - The maximum value of excess stress reached during the advancing mining is tracked and can be plotted as the mining steps progress.
  - Both the first yield step and the maximum yield steps are stored and can be displayed as trajectory numbers.

The new capabilities within MAP3D allows many of the behaviours previously only possible with non-linear and plastic modelling to be addressed.

This is done while still maintaining the ease of use and computational performance advantages of elastic modelling.

These capabilities largely negate any advantages that plastic modelling offers.

In the event that plastic simulation is required:

- Map3D Visco-Plastic offers the capability to fully simulate rock mass yielding using the same model input files.
- Map3D Fault-Slip offers the capability to fully simulate fault-slip yielding using the same model input files.

**Program Accuracy** - Solution accuracy is controlled by an automated discretization procedure. Elements can be automatically concentrated in areas of interest according to user controlled parameters. This relieves the user of the tedious process of manually discretizing their model, while improving accuracy and minimizing problem size.

**Problem Size** - Map3D can accommodate over 24 million degrees of freedom on a PC with a few GBs of disk space. Although small problems can be solved in minutes, the largest problems can require overnight or a few days. This tremendous efficiency is achieved by use of matrix lumping. This permits users to specify existing mine-wide mining geometry in detail, and add new mining as required. This greatly reduces the effort required to set up and run analyses and permits the whole mine to be considered when necessary.

**Multi-Processing/Multi-Disk** - Map3D fully supports parallel processing features such that computation times scales linearly with the number of processors (6 core processors solve problems 6 times faster than single core). In addition, the program has built in overlapped disk functionality allowing read and write rates to scale linearly with the number of disks (4 disk read/write rates are 4 times faster than single disk).

**Pre-processing** - A complete CAD package is incorporated into Map3D featuring numerous facilities for exchanging data with other CAD packages. Many features including the automated trace and extrude functions allow complex models to be built with ease. Extensive error checking and automatic correction routines allow almost any model geometry to be used. Boolean intersection routines correct overlapping and mismatched block connections without user intervention. There is full support of importing and exporting geometry files in either DXF or PNT (ASCII) format.

**Post-processing** - A complete display package is included featuring hundreds of plotting and data export functions. User defined plots and visually selected dumps of data ease the effort required for interpretation and reporting. Dumps can be done directly Excel and graphed automatically.

### Why Use Map3D

Map3D has been developed specifically for mining applications from the ground up. The program is designed to allow you to get high accuracy answers quickly, to get on with the engineering instead of the modelling. Large complex problems can be built easily either with Map3D's own CAD interface or outside the program then imported in a variety of different formats. No other program can handle the analyses that Map3D can in the time (run pre & post processing time), cost (many times cheaper) and ease (Map3D can be used on site for routine analyses). Some of the advantages of Map3D are as follows:

- Convenient upgrade path from elastic, fault slip, thermal/fluid-flow, non-linear and visco-plastic analysis (Map3D Versions) using the same interface
- Extensive training program for both program functionality and detailed engineering results interpretation (see Map3D Training)
- Powerful integrated CAD interface - no third party software required
- Easy construction of simple or complex 3D shapes.

- Very large problem sizes easily solved on a desktop computer (24,000,000 degrees of freedom)
- Automated facility to generate Excel plots from contoured data
- Probability of failure plots
- Automated block intersection capability relieves the user of manual construction effort
- Allows for backfill placement
- Multi-step mining sequences
- High accuracy elements (requires half as many elements to achieve the same degree of accuracy as most programs)
- Do to advanced lumping procedures, run times are very quick compared to other programs
- Up to 100 different material zones
- Visco-plastic fault slip simulations
- Tabular mining with yielding pillars
- Automated discretization ensures easily controlled and consistent degree of accuracy
- Powerful integrated results viewer
- Easy manipulation of results for interpretation of rock mass failure, slip on fault planes, results on oriented bore holes and ubiquitous slip on bedding planes or joint sets.
- Integrated interactive visualization database allows for display and contouring of seismic data
- Contour plotting of user defined functions
- Program support is included
- Continuous development and enhancements for over 26 years
- Incorporation of both Fictitious Force and Displacement Discontinuity elements (as well as special elements for thermal/fluid flow, and 3D plasticity).
- Higher order elements for bending problems
- Planar grids, line grids and point grids for viewing results
- Isotropic and anisotropic failure criteria
- RCF (Rock wall Condition Factor) plots
- Integrated accelerated, pre-conditioned and conjugate-gradient solvers work together for fast, reliable accurate solutions
- Import/export facility for input data to other CAD programs
- Import/export facility for analysis results to other programs
- No expensive buy in fees - Map3D is leased on an annual basis
- Direct interface to Deswick allowing users to create Map3D geometries including specification of Map3D block names, colours and mining sequence.
- Direct export to Excel, 3D-PDF, VRML and much more.

**Some Users** - Some current and past users of Map3D include: University of Toronto (Canada), Vale (formerly CRVD INCO Ontario) (Creighton Mine, Stobie Mine, Froid Mine, South Mine, Garson Mine, Levack Mine, Mines Research, Mines Technology - Methods & Design), INCO Manitoba (Canada), Noranda (Canada), CNG Softeck Co. (Korea), Anglo Gold (South Africa), Golder Associates (Canada and Australia), Placer Dome Western Area Joint Venture (South Africa), Mount Isa Mines (Australia), Brunswick Mining and Smelting (Canada), Goldcorp (Canada), Mincad Systems (Australia), Kanowna Belle Gold Mines (Australia), U. of British Columbia (Canada), U. of Western Australia, U. of New South Wales (Australia), Laval U. (Canada), McGill U. (Canada), Rock Mechanics Technology (England), Endeavor Mine (Australia), Australian Mining Consultants, Aur Resources (Canada), CSIR Division of Mining Technology (South Africa), Snowden Mining Industry Consultants (South Africa and Australia), Tara Mines (Ireland), Georock Inc. (Canada), Romec n.v. (Belgium), Agnico Eagle - Division Laronde (Canada), Queensland University (Australia), Geomechanics Research Centre Laurentian U. (Canada), Agnew Gold (Australia), Western Mining Corp. (Australia), Tao Lekoa Mine (South Africa), AngloGold Ashanti (South Africa and Australia), Kalgoorlie Consolidated Gold Mines (Australia), INWE Rock Engineering, Lourence Geotechnical

(Australia), Western Deep Levels (South Mine, West Mine, Regional Office), Zinkgruvan Mining AB (Sweden), Elandsrand Gold Mine (South Africa), TWP Consulting (South Africa), Tshepong Mine (South Africa), CAMBIOR Inc. (Canada), Natural Resources Canada, Avmin Target Mine (South Africa), SRK Consulting (South Africa, Australia, Sweden), U. of Waterloo (Canada), St Ives Gold (Australia), Mine Geant Dormant (Canada), Normandy Jundee Operation (Australia), KULeuven - Unit Mining (Belgium), Leinster Nickel Operation (Australia), Doyon Mine (Canada), ISS International (South Africa), ISS Pacific (Australia), Musselwhite Mine (Canada), Finsch Diamond Mine (South Africa), Queen's University (Canada), Plutonic Gold Mine (Australia), Campbell Mine (Canada), JCI Travistock Colliery (South Africa), Strata Control Technology (Australia), Cayeli Bakir Isletmeleri A. S. (Turkey), Asker - Thabazimbi ISCOR (South Africa), Douglas Partners (Australia), U. of Queensland (Australia), Bambanani Mine (South Africa), Palabora Mining Company Ltd. (South Africa), Newcrest Mining Ltd. (Australia), Delft U. of Technology (The Netherlands), ANGLOVAAL (South Africa), Impala Platinum (South Africa), Battle Mountain Canada, Black Mountain (South Africa), Tsumeb - Otjihase Mine (Namibia), Kloof, Division of Kloof G.M. Co. Ltd. (South Africa), Rustenburg Platinum Mines Ltd. (South Africa), Savuka Mine (South Africa), BCL Botswana (Botswana), Terra Sancta (Australia), Mines Aurizon - Casa Berardi (Canada), Rockland Ltd. (Canada), Darlot Gold Mine (Australia), Forrestania Gold NL (Australia), WA Department of Minerals and Energy (Australia), Great Central Mines - Wiluna Gold (Australia), Central Mines Engineering Group - Inco Ltd (Canada), Kundana Gold (Australia), Henty Gold Mine - Goldfields Ltd. (Australia), Elura Mine (Australia), Western Australia School of Mines, Cannington - BHP World Minerals (Australia), WMC Olympic Dam Operations (Australia), BFP Consultants Pty Ltd (Australia), Julius Kruttschnitt Mineral Research Centre (Australia), Mountan U. of Leoben (Austria), CNR-C.S. Problemi Minerari (Italy), Japan Nuclear Development Institute (Japan), Lassonde Mineral Engineering (Canada), Coffey Geosciences Pty Ltd (Australia), Pajingo Joint Venture (Australia), TauTona Mine (South Africa), Bronzewing - McClure Gold Operations (Australia), Normandy Golden Grove Operation (Australia), McArthur River Mining Pty Ltd (Australia), Boulby Mine - Cleveland Potash Limited (United Kingdom), AngloGold Ashanti Mineracao: Cuiaba (Brasil), Harmony Gold Mining Company Limited (Australia), Mirarco Mining Innovation (Canada), Northam Platinum Limited Zondereinde Division (South Africa), Open House Management Solutions (South Africa), Great Nologwa Mine (South Africa), Konkola Copper Mines (Zambia), Osborne Mines (Australia), Politecnico di Torino (Italy), Atomic Energy Canada, Ekati Diamond Mine (Canada), Musselwhite Mine (Canada), Cadia Holdings Ltd. (Australia), INGWE Rock Engineering (South Africa), Mountain University of Technology (Austria), Australian Centre for Geomechanics, Granites Gold Mine (Australia), Northparkes Mines (Australia), Basis Soft Inc. (Korea), Ritsumeikan University (Japan), Science & Technology Central South University (Changsha, Hunan China), Groundwork Consulting (Australia), LionOre Australia, MPI Mines (Australia), Lisheen Mine (Ireland), Northeastern University (Shengyang, Liaoning, P.R.China), Beck Arndt Engineering (Australia), La Mine Niobec (Canada), Second Avenue Subway (New York USA), Anglo Platinum (South Africa), Ressources MSV Inc. (Canada), Selwyn Operations (Australia), Newmont Australia Technical Services (Australia), Kigam - Geotechnical Engineering Division (Korea), Dempers and Seymour P/L (Australia), Cobar Management Pty Ltd (Australia), Big Bell Mining Operations (Australia), Auriongold Kalgoorlie Operations (Australia), Peak Gold Mines (Australia), Driefontein Consolidated (Pty) Ltd (South Africa), Newmont - Pajingo Joint Venture (Australia), AurionGold - Paddington Gold Pty Limited (Australia), Mincor Operations (Australia), Falconbridge Ltd. (Canada), Sons of Gwalia - Southern Cross Operations (Australia), E-Mining Technology S.A. (Chile), Beaconsfield Gold (Australia), MMG Rosebery Mine (Australia), Instituto Innovacion en Minería y Metalurgia (Chile), IRSM of Chinese Academy of Sciences (China), Brently, Lucas & Associates (South Africa), Kirkland Lake Gold Inc. (Canada), Chelopech Mining AD (Bulgaria), Northwind Enterprises (Australia), Cameco Corporation (Canada), Barrick Goldstrike Mines (USA), Barrick Gold -Lawlers Gold Mine (Australia), RMIT - Faculty of Engineering (Australia), Perilya Broken Hill Ltd (Australia), Placer (PNG) - Porgera Joint Venture (Papua New Guinea), Codelco Chile - Division Andina (Chile), Codelco Chile - Division EI

Teniente (Chile), Codelco Chile - Division Norte (Chile), IM2 S.A. - Filial Codelco (Chile), Codelco Chile - Division Salvador, Geo-Engineering Technology Limitada (Chile), Xstrata Copper (Australia), Xstrata Nickel (Australia), Mining Geotechnical Solutions (Australia), Freeport McMoRan Copper & Gold (USA), Kopanang Gold Mine (South Africa), Seoul National University (Korea), Lawlers Gold Mine (Australia), Bendigo Mining Limited (Australia), Codelco, Gerencia Corporativa (Chile), Stawell Gold Mines (Australia), Samancor - Western Chrome Mines (South Africa), Mponeng Mine (South Africa), KMCL - Bulyanhulu Site (Tanzania), Ballarat Goldfields (Australia), Goldfields Mine Management (Australia), Dynatec Corporation (Canada), P.T. Freeport Indonesia, EKJV Management (Australia), BHPB Nickel West - Leinster Nickel Operation (Australia), Birla - Mt. Gordon (Australia), Ridgeway Project - Cadia Holdings (Australia), U. of South Australia, Sunrise Dam Gold Mine (Australia), Oxiana Golden Grove (Australia), Moab Khotsoeng Mine (South Africa), MIDD & MIDDindi Consulting (South Africa), Redco Ltda (Chile), Mining One Pty Ltd (Australia), Birla Nifty - Nifty Copper (Australia), Cracow Gold Mine (Australia), Beta-Hunt Mine (Australia), Universidad de Chile - Facultad de Ciencias Fisicas y Mathematicas, Geotechnical Consulting Pty Ltd (Australia), NVI Mining Ltd. Myra Falls (Australia), East Bolder Mine - Stillwater Mining (USA), Cambior - La Mine Geant-Dormant (Canada), University of Quebec Chicoutimie (Canada), New Gold Afton Project (Australia), A Karzulovic & Associates (Chile), Strata Engineering (Australia), Peter O'Bryan & Associates (Australia), Barrick Granny Smith (Australia), Xstrata Nickel - Raglan Mine (Canada), Genivar (Canada), President Steyn Gold Mine (South Africa), GFL Mining Services Limited (South Africa), Mopani Copper Mine (Zambia), Tau Lekoa Mine (South Africa), Stanford University Department of Geophysics (USA), Simon Fraser University - Department of Earth Sciences (Canada), Resolution Copper Company (Canada), North American Tungsten Corporation (Canada), Gold Fields Technical Services (South Africa), Maggie Hays - Lake Johnston Operations (Australia), Nickel West Cliffs Project - BHP Billiton (Australia), Ditton Geotechnical Services (Australia), GeoMech Services (Australia), Outokumpu Torino Works (Finland), Wardell Armstrong International Ltd (UK), Cosmos Nickel Project - Jubilee Mines NL (Australia), Long Nickel Project - Lighting Nickel Pty (Australia), RESPEC (USA), Xstrata Nickel - Craig Mine (Canada), Northern 3500 Orebody - Xstrata Copper (Australia), Xstrata Zinc - Mount Isa Mines (Australia), Goldfields - Beatrix 4 Shaft (South Africa), Omya Central Europe (Austria), Pyhasalmi Mine Oy (Finland), Outokumpu Torino Works (Finland), Mining One Pty Ltd (Australia), P.T. Newmont Tenggara (Indonesia), Peak Gold Mines (Australia), Argyle Diamond Mine (Australia), Bullant Gold Mine (Australia), Geosnergia Ingenieria y Medio Ambiente Ltd (Chile), Lonmin Platinum (South Africa), DERK Ingenieria y Geologia Ltda (Chile), Montana Exploradora de Guatemala S.A.(Guatemala), St. Barbara Limited (Australia), Boliden Mineral AB (Sweden), Vattenfall Power Consultant (Sweden), Lulea University of Technology (Sweden), LKAB Mining Technology (Sweden), Associacao Instituto Technologio Vale - ITV (Brasil), Mina San Rafael, S.A. - Mina El Escobal (Guatemala), Hecla - Lucky Friday Mine (USA), Kittila Mine - Agnico-Eagle Finland Oy (Finland), Central Institute of Mining and Fuel Research (India), Sibanye Gold (South Africa), Global Mine Design (UK), Eagle Mine LLC (USA), Newmont USA Limited - Leeville Operation (USA), Agnico Eagle Mines Limited (Mexico), NIOSH OMSHR Pittsburg Mining Research Division (USA), ARANZ Geo Limited (New Zealand), Thiess Pty Ltd (Australia), Glencore - Ernest Henry - Copper (Australia), Syama Mine, Society des Mines de Syama (Mali), Glencore Mount Isa Mines Ltd (Australia), La Mancha Resources - Frogs Leg Mine (Australia), Northern Star Resources Limited (Australia), Dundee Precious Metals - Kapan (Armenia), Minera Cuzcatlan (Mexico), Minera Candelaria (Chile), SVS Ingenieros (Chile), ENAMI CHILE (Chile), Kibali Gold Mine - Randgold Resources Ltd. (Democratic Republic of Congo), Unki Mines (Pvt) Ltd (Zimbabwe), Lady Loretta - Zinc Assets Australia (Australia), Salt Lake Mining Pty Ltd (Australia), Mt Carlton and Pajingo - Evolution Mining (Australia), NIOSH OMSHR Spokane Research Lab (USA), Rubicon Minerals Corporation (Canada), Les Mines Opinaca Ltee, Projet Eleonore (Canada), Lac des Iles Mine - North American Palladium (Canada), Pakalnis and Associates (Canada), Nyrstar - Langlois Mine (Canada), Mufulira Mine - Mopani Copper Mines Plc (Zambia), Black Mountain (South Africa), Bindura Nickel Corporation, Trojan Nickel Mine

(Zimbabwe), Fosterville Gold Mine Pty Ltd (Australia), Ranger 3 Deeps - E.R.A. (Australia), Kazzinc Ltd (Kazakhstan), Independence Group - Jabiru - Jaguar Limited (Australia), MMG - Dugald River Mine (Australia), AuRico Gold Inc (Canada), Nyrstar Myra Falls Ltd (Canada), Universidad de Chile (Chile), GMT Ltda (Chile), MINSUR S.A. (Peru), AMEC Chile (Chile), Compania Minera El Toqui (Chile), Devourge Industries Ltd (Zambia), Assmang Manganese - Black Rock Mine Operation (South Africa), School of Engineering and ICT, U. of Tasmania (Australia), Primero Gold Canada Inc (Canada), AMEC Earth and Environmental (Canada), Mine Westwood - IAMGOLD (Canada), Stantec Inc (Canada), Knight Piesold Ltd (Canada), Osisko Mining Corporation (Canada), Kinross Gold Corporation - Technical Services (Canada), Silver Lake Resources, Daisy Milano Mine Site (Australia), Minerals and Metals Group, Golden Grove (Australia), South32 Cannington Pty Ltd (Australia), Morobe Mining, Nine Mile, Awilunga Estate (Papua NewGuinea), Copper Mines of Tasmania (Australia), AngloGold Ashanti Mineracao: Cuiaba Brasil, Mineracao Serra Grande (Brasil), Xstrata Zinc, Mine Matagami (Canada), St. Andrew Goldfields Ltd., Holt-Holloway Mine (Canada), Hecla Quebec - Casa Berardi (Canada), Barrick Cortez (USA), Barrick Gold Corp. - Hemlo Operations (Canada), ASDR Industries (Canada), Centre for Excellence in Mining Innovation (Canada), Two Rivers Platinum (Pty) Ltd (South Africa), Chibuluma Copper South Mine PLC (Zambia), Loulo Mine, Randgold Resources Limited (Zambia), Santiago University (Chile), Tomas Fernando Villegas Barba (Mexico), ACE [Arab Consulting Engineers] (Egypt), Growth & Intl Projects, GoldFields Australasia (Australia), Tritton Resources Pty Limited (Australia), Compania Minera San Geronimo (Chile), Jacobina Mineracao - Yamana Gold Inc (Brasil), FF GeoMechanics (Chile), Minera Florida Ltda (Chile), Minera Triton S.A. (Nicaragua), Minera Sierra Gorda SCM (Chile), Sociedad Minera El Brocal S.A.A. (Peru), GFI Mining SA (Pty) Ltd, Kloof Division (South Africa), AngloGold Ashanti - Obuasi Mine (Ghana), ARMgold/Harmony Freegold JV (South Africa), BCG Engineering Inc (Canada), University of New South Wales (Australia), Agnico-Eagle - Division Goldex (Canada), McArthur River Mine - Cameco Corporation (Canada), Thinkrox Inc (Canada), New Gold Inc., New Afton (Canada), Snap Lake Mine, De Beers Canada Inc (Canada), Mine Design Engineering (Canada), DB Operating Corporation (Canada), BCD Resources (Operations) NL - Tasmania Mine (Australia), Minera El Toqui (Chile), Capstone Gold S.A. (Mexico), Universidad De La Serena (Chile), Segala Mining Co SA (SEMICO SA) (Mali), Bariq Mining Limited (Saudi Arabia), TREM Rock Engineering (South Africa), U. of Saskatchewan, Civil & Geological Eng. (Canada), Call & Nicholas Inc (USA), LVI Geotechnical (Australia), Camborne School of Mines, U. of Exeter (UK), PUCOBRE (Chile), Compania Minera Dona Ines de Collahuasi (Chile), Compania Minera Nevada SpA (Chile), Mining Plus Pty Ltd (Australia), Flying Fox Mine - Forrestania Nickel Project (Australia), Oceana Gold Didipio Operations (Philippines), Sandfire Resources NL (Australia), MineGeoTech Pty Ltd (Australia), 2M Engineering (Indonesia), MINERA MILPO S.A.A (Peru), Siga Ingenieria Y Consultores S.A. (Chile), Bluestone Mines Tasmania Joint Venture (Australia), Barrick (Australia Pacific) Yilgarn (Australia), Apex Gold Pty Ltd (Australia), Jennmar Australia Pty Ltd (Australia), Tecnologia Y Geociencias Limitada (Chile), Kazakhmys Services Limited (Kazakhstan), Cairo University - Faculty of Engineering (Egypt), Isa Ashari Qudraturrahman (CV PRJ) (Australia), Ezulwini Mine - First Uranium Corporation (South Africa), University of Pretoria (South Africa), Eldorado Gold Corporation (China), Carpentaria Gold - Ravenswood Operations (Australia), Anglo Coal Australia Pty Ltd (Australia), Eastplats Ltd - Crocodile River Mine (South Africa), Great Nologwa Mine (South Africa), Randfontein Estates - Harmony Gold Mining Co (South Africa), PipeFlo (South Africa), Haldeman Mining Company S.A. (Chile), ARCADIS CHILE S.A (Chile), Geomechanicos Consultores Ltda (Chile), Otter Juan Mine - Goldfields Mine Management (Australia), Straits Resources Limited (Australia), Halcrow Group Limited (Australia), Mine-concept Engineering Services (Canada), Diavik Diamond Mines Inc (Canada), Green Geotechnical Pty Ltd (Australia), Custom GeoEng Solutions Inc (Canada), Ingenieria de Rocas Limitada (Chile), BHP Billiton Energy Coal South Africa Ltd (South Africa), Luanshya Copper Mines Plc (Zambia), Brentley, Lucas & Associates Pty Ltd (South Africa), Oz Minerals (Australia), Rio Tinto - Technology and Innovation (USA), InnovExplo Inc (Canada), AMEC Foster Wheeler Americas (Canada), Geohart Consultants



Pty Ltd (Australia), ROCKLAND LTD (Canada), Sudbury Integrated Nickel Operations, Glencore (Canada), East Boulder Mine - Stillwater Mining (USA), Breakwater Resources Ltd (Canada), School of Resources & Safety Eng - Central SU (China), Manxmin Pty. Ltd (Australia).

Map3D is developed and supported by:

The logo for Map3D, featuring the text "Map3D" in a stylized, golden, 3D font.

Dr. Terry D. Wiles  
Map3D International Ltd.  
Email: [support@map3d.com](mailto:support@map3d.com)  
Website: [www.map3d.com](http://www.map3d.com)  
Tel: (+1) 647 729 7572

Map3D is licensed, not sold. Use of Map3D is through a leasing arrangement, controlled by a time-based protection key. The program is normally leased on an annual basis however multiple year leases can be negotiated in advance.

Sales and support are provided by the author and through a network of agents worldwide including:



Ken McNabb  
Mincad Systems Pty Limited  
Box 2114, Richmond South, Victoria  
3121 Australia  
Email: [mincadhq@mincad.com.au](mailto:mincadhq@mincad.com.au)  
Website: [www.mincad.com.au](http://www.mincad.com.au)  
Tel: (+61) 3-9427-1085  
Fax: (+61) 3-9428-1197



John Hadjigeorgiou  
Georock Inc.  
17 Highborne Road, Toronto, Ontario  
Canada M5P 2J1  
Email: [georock@rogers.com](mailto:georock@rogers.com)  
Tel: (+1) 647 351 0841



Administration and Orders  
Danie Truter

Tina Samuel  
Technical Support  
Gerrit Kotze  
Open House Management Solutions  
PO Box 200, 77 Dr James Moroka Avenue  
Potchefstroom 2531 South Africa  
Tel: (+27) 18 293 1400  
Mobile: (+27) 18 293 1940  
Email: [Danie.Truter@ohms.co.za](mailto:Danie.Truter@ohms.co.za)  
Email: [tina.samuel@ohms.co.za](mailto:tina.samuel@ohms.co.za)  
Email: [gerrit.kotze@ohms.co.za](mailto:gerrit.kotze@ohms.co.za)  
Website: [www.ohms.co.za](http://www.ohms.co.za)



TECNOLOGIA Y GEOCIENCIAS

Claudio Martinez  
Tecnología Y Geociencias Limitada  
Valenzuela Castillo 1341, Of.205  
Providencia-Santiago-Chile  
Tel: (+56) 2 2 275 61 08  
Mobile: (+56) 9 0153889  
Email: [info@tecnologiaygeociencias.cl](mailto:info@tecnologiaygeociencias.cl)  
Website: <https://www.tecnologiaygeociencias.cl>



Mahdi Bayuargo  
2M Engineering  
Jl. KPR Pemda 2 SP V No. 45  
Timika Papua Indonesia 99910  
Tel: (+62) 81389-202349  
Email: [mahdi@mmeconsultant.com](mailto:mahdi@mmeconsultant.com)  
Website: <http://www.mmeconsultant.com>



Vadim Louchnikov  
LVI Geotechnical  
19 Columbus Loop

Success, WA 6164 Australia  
Tel: (+61) 438 862 436  
Email: [contact@lvigeotechnical.com](mailto:contact@lvigeotechnical.com)  
Website: <http://www.lvigeotechnical.com>



Srinath Srinivasaiah  
Akasha Enterprise  
11/1 Mosque Road, Aramane Nagar, Bangalore  
560 003 India  
(+91) 961 124 1345  
(+91) 821 419 4125  
Email: [srinath@akasha.co.in](mailto:srinath@akasha.co.in)  
Website: [www.akasha.co.in](http://www.akasha.co.in)

### 1.3 Map3D Overview

Map3D has the ability to simulate everything from simple tabular shapes to detailed 3D excavation shapes and large scale mine wide problems. The difficulty users will encounter in model construction and interpretation depend on the amount of complexity required for the simulation at hand. While simple tabular models or single tunnels are fast and easy to construct in Map3D, complex three-dimensional problems are inherently difficult to work with and interpret.

Map3D has a completely self-contained CAD facility. One of the keys to the ease of use is model construction using either conventional surface elements or the built-in solid modelling technology. This permits users to build models using a series of three-dimensional building blocks. These blocks, which can be any desired shape or size, are used to construct excavations and accesses, as well as to define large or irregular shaped non-homogeneous zones (ore zones, dykes and yielding zones). All of the material outside the model boundary is assumed to be a solid host material. Direct interface to Deswick allowing users to create Map3D geometries including specification of Map3D block names, colours and mining sequence.

The program automatically builds intersections between excavations, faults and multiple material zones. By coupling this capability with the built-in Boolean operations, complex multi-step mining sequences can be constructed with ease.

Special features have been implemented to allow fast construction of tabular mining shapes. The user need only specify the perimeter of each mining step and Map3D automatically builds the required elements. The perimeter does not necessarily have to be planar. In fact any bounding polyhedron of three-dimensional points are acceptable. Complex, multi-reef, non-tabular (rolling or offset) mining is readily simulated. Intersecting faults or three-dimensional dykes can be simulated.

The tabular mining can be extruded into 3D blocks then back into tabular mining if desired. This allows construction of detailed development to be completed very quickly. Also different parts of the model can be simulated using the tabular approximation while details can be obtained in areas of interest by using true 3D shapes.

Wireframe mine plan outlines and excavation geometries can be digitized from within Map3D or imported from several sources including AutoCAD-DXF and a universal ASCII PNT format. The user can interactively build a model comprising 3D blocks and planes using the built-in CAD capabilities of

Map3D. Based on the geometric outlines or free-hand drawing, the user picks corners of blocks and planes to complete construction of the model. All of this is done graphically using the comprehensive set of tools available in the CAD interface.

A model comprises one or more connected or unconnected blocks and/or planes that can be mined and filled in a specified sequence. Surfaces of blocks and planes are subsequently discretized into a number of boundary elements by the program. Extensive error checking assists the user in identifying whether the geometry is topographically valid or not.

The same input data can be used for elastic, thermal/fluid flow or non-linear analysis

#### [Map3D Versions](#)

Analysis results can be contoured on element surfaces or on a series of user defined field point grid planes. These latter planes can be positioned at any desired location and allow contouring of stresses, strains, displacements, strength factors or any desired combination of these components. Line contours and/or colour filled contours can be generated with options for labels, trajectories, transparency, grid lines and more.

Results can be exported in many formats including raster screen dumps, vector screen dumps or selected grid or surface locations with user configurable format.

#### [Applications](#)

## 1.4 Applications

Map3D is suitable for modelling rock engineering design problems involving both large tabular ore bodies and irregular massive excavations.

The program is designed to be very versatile in its application. It has the ability to simulate everything from simple tabular shapes to detailed 3D excavation shapes and large scale mine wide problems. Models can include tunnels, large irregular shaped excavations, ore zones, massive and tabular excavations, open pits, faults, fractures and more. It is possible for excavations to be intersected by multiple faults or discontinuities that are allowed to slip or open. Problem size and complexity are only limited by the amount of detail the user wants to incorporate.

Map3D can simulate ground support elements such as arches, steel sets, props, thick liners, chocks, strong backfill etc. When simulating stiff support systems such as arches, steel sets, props, thick liners, chocks, strong backfill etc., it is necessary to model the ground movement up to the point of support placement, then insert the support elements either in a stress/strain free state, or with a prescribed pre-stressing. This feature is particularly useful for simulation of structural support elements and can accommodate placement, modification of properties and subsequent removal if desired. This option has been enabled for use with 3D FF blocks and/or DD planes.

To enable this feature you must first excavate the desired support element (either a 3D FF block or DD plane) to the desired pre-stressed state (use a zero material code for zero stresses or a negative material number for a prescribed stress state), then in a subsequent mining step insert the support material (use a positive material number to do this). With the Analysis > Options > Zero Strain Support Placement option checked, Map3D conducts the necessary calculations to place support elements in a stress/strain free state or with a prescribed pre-stressing at the current mining step. The action of excavation to a zero or prescribed stress state followed by insertion of an alternate material signals Map3D to conduct the required calculations.

Map3D can be applied to the analysis of underground layout and mining sequence problems, as well as the assessment of pillar designs, stope span stability and fault stability. Depending on the version

being used, non-linear material behaviour can be used when modelling pillars, seams and abutments.

There is a facility to superimpose external field loading effects into the Map3D model [Map3Di](#).

There is also a facility to visualize point data [Seismic](#). Points can be displayed as light source shaded spheres with diameter and/or colour varying as magnitude. Each point can be tagged with a series of numeric values (e.g. colour, magnitude, orientation etc.) and a text message. Upon clicking on a point, the location, magnitude and text message are displayed on the status bar. This feature can be used to display a database of useful geologic information such as grade, rock mass quality etc.

The field loading can come from thermal heating, fluid pressure, non-linear behaviour and deformations indicated by seismicity. These effects can be used to characterize geologic features, accommodate changing lithology and incorporate seismic loading effects into the Map3D model.

[Model Building Overview](#)

## 1.5 Model Building Overview

Map3D is based on the Boundary Element formulation. With this method, one starts with an infinite homogeneous elastic medium (rock mass). The process of model building consists of making excavations and superimposing non-homogeneous zones (dykes, ore zones or yielding zones) and any faults or joints upon which slip may occur. Since one starts with an infinite medium, far field boundaries are automatically accommodated.

This is unlike domain formulations such as the Finite Element or Finite Difference methods, where one starts with empty space. For these latter methods, model building consists of assembling the entire rock mass and all its components. Elements must be assembled out to some far field boundary many diameters away from the excavations.

These fundamental differences make the boundary element method much more suitable and economic (in terms of analysis time) for rock mass problems.

There are several types of boundary elements available in Map3D:

Fictitious force (FF) elements are used to specify the location of excavation surfaces and boundaries between regions with differing material properties.

Displacement discontinuity (DD) elements are used to specify the location of joints, faults, fractures, pit walls and ground surface. These elements can intersect excavations at any location, since Map3D builds edge intersections internally.

Inactive elements are used to construct excavation surfaces that can be displayed, but are not used in the stress analysis.

Special proprietary boundary elements are incorporated for the thermal and non-linear analysis versions.

[Boundary Element Formulation](#)

The objective of model building is to create a series of surface patches that when taken together, form a seamless, non-overlapping, continuous skin which describes the location of excavations, boundaries of regions with different moduli, faults etc. These surfaces must be further subdivided into smaller boundary elements where the actual influence functions are evaluated and solved. This approach is called surface modelling.

The user is free to construct surface models and supply this basic input data to Map3D. While this approach is ideal for describing ore outlines or as-built models, it has been found to be tedious and

error prone when constructing mine layouts. In order to simplify model building, the program has a powerful pre-processor built into it that can accept and manipulate higher order three-dimensional entities. This approach is called solid modelling.

Solid modelling permits users to build models using a series of three-dimensional building blocks. These blocks, which can be any desired shape or size, are used to construct excavations and accesses, as well as to define non-homogeneous zones (ore zones, dykes and yielding zones).

The program automatically builds intersections between excavations, faults and multiple material zones. By coupling this capability with the built-in Boolean operations, complex multi-step mining sequences can be constructed with ease. Map3D creates the required surface description and automatically discretizes these surfaces into elements for the boundary element stress analysis.

[Rock mass Response Predictions Using Numerical Modelling](#)

## 1.6 Boundary Element Formulation

Numerical modelling is an attempt to mathematically simulate the way the rock mass responds to mining. This is done by accommodating the effects of:

- Loading conditions - Prior to mining the rock mass is loaded by overburden and tectonic forces.
- Structural support elements - There may also be loads due to mechanical ground support, backfill, heating, etc.
- Geometry - When you make excavations, these pre-existing loads are redistributed around the excavations, concentrating in abutments and pillars. Stiff dykes and soft ore zones will also influence the response.
- Elasticity - At locations where the stresses do not exceed the strength, the rock deforms in a more or less elastic manner. This simply means that the deformations are relatively small in magnitude and are mostly recoverable.
- Non-linearity - At locations where the stresses are concentrated to the point where they exceed the strength, the rock will yield to these loads and deform. This means that the deformations can be relatively large in magnitude and are mostly non-recoverable. This can include the effects of fault slip, cracking and generalized 3D non-linear yielding.

### How does numerical modelling work?

Numerical modelling achieves this simulation by using certain physical constraints on how the rock mass can respond:

**Equilibrium** – Applied forces must always balance one another at all locations in the model. If you cut out a small cube of material and examine the stresses acting on this cube these stresses must be in equilibrium.

$$\begin{aligned}\frac{\partial \sigma_{xx}}{\partial x} + \frac{\partial \tau_{xy}}{\partial y} + \frac{\partial \tau_{xz}}{\partial z} + X &= 0 \\ \frac{\partial \tau_{xy}}{\partial x} + \frac{\partial \sigma_{yy}}{\partial y} + \frac{\partial \tau_{yz}}{\partial z} + Y &= 0 \\ \frac{\partial \tau_{xz}}{\partial x} + \frac{\partial \tau_{yz}}{\partial y} + \frac{\partial \sigma_{zz}}{\partial z} + Z &= 0\end{aligned}$$

Note that terms **X**, **Y** and **Z**, represent body forces that can be used to apply any sort of external field loading. Such field loading can be the result of heating, fluid pressures material non-linearity etc. In addition, these can be determined from many forms of in situ monitoring including for example fluid pressures (e.g. well drawdown, dams, hydrofracturing), heating (e.g. natural heating, nuclear waste storage), deformations (e.g. monitored with extensometers), and seismic activity (e.g. definition of

fault slip or material non-linearity from seismic data). It is these terms that will be used for the integration of numerical modelling with seismic monitoring in [Map3Di](#).

**Continuity** – In the rock mass continuum, the mass of material must be maintained. You cannot have material disappearing or being created.

$$\begin{aligned}\partial^2 \varepsilon_{xx} / \partial y^2 + \partial^2 \varepsilon_{yy} / \partial x^2 &= 2 \partial^2 \varepsilon_{xy} / \partial x \partial y \\ \partial^2 \varepsilon_{yy} / \partial z^2 + \partial^2 \varepsilon_{zz} / \partial y^2 &= 2 \partial^2 \varepsilon_{yz} / \partial y \partial z \\ \partial^2 \varepsilon_{zz} / \partial x^2 + \partial^2 \varepsilon_{xx} / \partial z^2 &= 2 \partial^2 \varepsilon_{zx} / \partial z \partial x \\ \partial^2 \varepsilon_{xx} / \partial y \partial z &= \partial / \partial x ( -\partial \varepsilon_{yz} / \partial x + \partial \varepsilon_{zx} / \partial y + \partial \varepsilon_{xy} / \partial z ) \\ \partial^2 \varepsilon_{yy} / \partial z \partial x &= \partial / \partial y ( -\partial \varepsilon_{zx} / \partial y + \partial \varepsilon_{xy} / \partial z + \partial \varepsilon_{yz} / \partial x ) \\ \partial^2 \varepsilon_{zz} / \partial x \partial y &= \partial / \partial z ( -\partial \varepsilon_{xy} / \partial z + \partial \varepsilon_{yz} / \partial x + \partial \varepsilon_{zx} / \partial y )\end{aligned}$$

**Elasticity** - At locations where the stresses do not exceed the strength, the rock deforms in a linear elastic manner: stresses varying in direct proportion to the elastic strains.

$$\begin{aligned}\sigma_{xx} &= \sigma_{xx}^{\circ} + [ (1-\nu) \varepsilon_{xx} + \nu ( \varepsilon_{yy} + \varepsilon_{zz} ) ] E / [(1+\nu)(1-2\nu)] \\ \sigma_{yy} &= \sigma_{yy}^{\circ} + [ (1-\nu) \varepsilon_{yy} + \nu ( \varepsilon_{zz} + \varepsilon_{xx} ) ] E / [(1+\nu)(1-2\nu)] \\ \sigma_{zz} &= \sigma_{zz}^{\circ} + [ (1-\nu) \varepsilon_{zz} + \nu ( \varepsilon_{xx} + \varepsilon_{yy} ) ] E / [(1+\nu)(1-2\nu)] \\ \tau_{xy} &= \tau_{xy}^{\circ} + \varepsilon_{xy} E / (1+\nu) \\ \tau_{yz} &= \tau_{yz}^{\circ} + \varepsilon_{yz} E / (1+\nu) \\ \tau_{zx} &= \tau_{zx}^{\circ} + \varepsilon_{zx} E / (1+\nu)\end{aligned}$$

Note that this is where the pre-mining or far-field stresses ( $\sigma^{\circ}$ ) are incorporated into the physics.

**Non-linearity** - At locations where the stresses are concentrated to the point where they exceed the strength, the rock will yield to these loads and deform. Deformations are all allowed to proceed until the stresses relax down to the strength. This may be accompanied by some dilation. This can include the effects of fault slip, cracking and generalized 3D non-linear yielding.

Note that the equations of equilibrium and continuity are expressed as differential equations. What we need to do to solve these is to integrate them over the rock mass volume such that the appropriate boundary conditions are satisfied. There are many ways of accomplishing this. Boundary Element Methods integrate the equations analytically, and then use a numerical approximation to satisfy the boundary conditions. Finite Element Methods and Finite Difference Methods use a numerical integration scheme to integrate the differential equations.

No matter which method is used, in the end they all use some sort of numerical approximation and you end up with a large set of equations that describes how various parts of the rock mass interact upon one another. In BEM the resulting equations appear as

$$\sigma_{\text{surface}} = \sigma_{\text{far\_field}} + M P$$

where  $M$  is the set of simultaneous equations and  $P$  represents the loads or deformations that need to be applied to cause the stresses at the excavation surfaces to be zero. This constitutes a mathematical description of how the rock mass responds. All numerical models use some variation on this approach.

These equations need to be solved simultaneously such the boundary conditions are satisfied. By solving these equations throughout the rock mass, along with the loading conditions and geometry, you conduct a "stress analysis".

Map3D is based on a very efficient Indirect Boundary Element Method (Banerjee and Butterfield, 1981), and incorporates simultaneous use of both fictitious force and displacement discontinuity elements. Special proprietary boundary elements are incorporated for the thermal and non-linear analysis versions.

This Boundary Element formulation offers many advantages over other stress analysis techniques. Direct Boundary Element formulations require approximately twice the computational effort to assemble and solve the boundary element matrix, compared to the indirect method used in Map3D.

Matrix lumping techniques are used to reduce the matrix size, and as a result, very large problems (more than 333333 elements - 1000000 degrees of freedom) can be accommodated on PC platforms. Without lumping, a 64000 element problem would take 147 GB of disk space. With lumping, this can be reduced to less than 1 GB. This permits users to specify existing mining geometry in detail, and add new mining as required. This greatly reduces the effort required to set up and run analyses and permits the whole mine to be considered when necessary.

With the Boundary Element formulation, one starts with an infinite homogeneous elastic medium (rock mass). The process of model building consists of making excavations and superimposing non-homogeneous zones (dykes, ore zones or yielding zones) and any faults or joints upon which slip may occur. Since one starts with an infinite medium, far field boundaries are automatically accommodated.

This is unlike domain formulations such as the Finite Element or Finite Difference methods, where one starts with empty space. For these latter methods, model building consists of assembling the entire rock mass and all its components. Elements must be assembled out to some far field boundary many diameters away from the excavations.

While Finite Element and Finite Difference formulations are very well developed for non-linear problems such as plasticity, transient heat and fluid flow, and dynamic simulations, there are also very difficult to use and require very long run times. The difficulty in use comes from the large amount of information required to discretize the host rock mass. While this can be minimized by use of mesh generators and powerful front-end graphics, the cost and effort to learn the interface outweighs the simplicity with which the Map3D Boundary Element analyses can be conducted.

These fundamental differences make the boundary element method much more suitable and economic (in terms of analysis time) for rock mass problems.

Many of the supposed limitations of the boundary element method have been overcome in Map3D. The program can accommodate multi-step mining sequences and multiple material zones with different material properties and stress states. These zones are permitted to behave non-linearly. Multiple intersecting fault planes can slip and open according to user specified shear strength. Steady state thermal/fluid stress analysis can be simulated.

The built-in solid modelling technology makes model construction very straightforward by building complex intersections internally. The discretization routines built into Map3D relieve the user of the burden of attempting to optimize the use of elements by automatically concentrating them only where results are requested. The internal lumping procedures reduce both matrix size and computational effort to a nearly linear dependence on problem size.

## **1.7 Rock Mass Response Predictions Using Numerical Modelling**

The simple goal of numerical modelling is to predict (with accuracy and reliability) how the rock mass will respond to mining. We specify the loading conditions, specify the geometry (this can include dykes, faults, bedding etc.), require equilibrium and continuity, assume that elasticity and/or non-linearity applies, then solve these equations for the stresses, strains, displacement etc. throughout



the rock mass.

By examining the results from the stress analysis we can identify locations that are for example over-stressed or yielding. We can determine what locations need support and what type of support is appropriate, etc.

Knowing what problems to expect, and the time and location of these problems is the ultimate goal. This allows you to compare alternative mine layouts and sequences, and to develop strategies to deal with problems when they occur. It avoids unexpected production interruptions. It allows you to lay down hard design numbers for support requirements, specific pillar widths, acceptable stope heights, etc. In short it provides a tool that helps you to design your mine. While numerical modelling is reasonably straightforward, interpreting the results is much more of a challenge. Numerical modelling for rock mass predictions is not an exact science. There will always be rock mass features that are not anticipated or understood.

The following quotation from Starfield and Cundall (1988) suggests several reasons why this is so.

*Rock mechanics models fall into the class of "data-limited problems": one seldom knows enough about the features and behaviour of the rock mass to model it unambiguously. It follows that one cannot use models in rock mechanics in a conventional way (for example in electrical or aerospace engineering), and that there is a need to adopt a distinctive and appropriate methodology for rock mechanics modelling.*

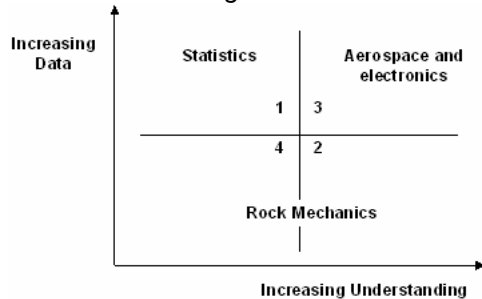

(after Starfield and Cundall, 1988)

Problems are often ill posed, leading to difficulties in interpreting the results and the nagging question of whether or not the correct problem has been modelled. The design of the model should be driven by the questions that the model is supposed to answer rather than the details of the system that is being modelled. This helps to simplify and control the model.

A model is a simplification of reality rather than an imitation of reality. It is an intellectual tool that has to be designed or chosen for a specific task. The fundamental problem is the question of resolution. One is nervous of over-simplifying the problem.

It is futile ever to expect to have sufficient data to model rock masses in the conventional (for example in electrical or aerospace engineering) way. As one includes more and more detail one loses intellectual control of the model and so it becomes less instead of more effective.

### **What is the conventional approach for applying numerical modelling to mine design?**

In most other engineering disciplines (electrical or aerospace engineering), numerical modelling is normally based on predicting response based on laboratory measured properties of materials. This generally works well if the materials, geometry and loading conditions are well known.

By contrast, the conventional method for applying numerical modelling to mine design is based on "Terzaghi's Observational Approach to Design".

Initially (i.e. pre-mining) you can conduct parametric studies. You can compare alternate designs and

identify important factors affecting stability. You may find that certain orientations are more favourable than others, or perhaps that certain sequences are better choices than others. You can make some broad estimate of the cost-benefit of increased production versus increased maintenance and support requirements.

Knowing what type of problems to expect and locations that are particularly susceptible is certainly useful information as this allows you to develop strategies to deal with problems if and when they occur. But if you want to use modelling to lay down hard design numbers for support requirements, specific pillar widths, acceptable stope heights, and actual costs, you need to have confidence in the accuracy of your predictions.

For example, there would be no point in specifying that a pillar be made 1.2m wide based on a model prediction if you had no idea how reliable this prediction was. You would never allow personnel to walk under a brow based on modelling results that indicated the brow was safe unless you also were confident that the predictions were reliable.

It is fundamentally necessary to have knowledge of the reliability of a prediction to access risk and base cost benefit decisions on.

It is worth spending a moment to reflect on this statement. I can think of no examples where predictions of unknown reliability are of any value. You may admit that the reliability of your prediction is low and that your predictions could be  $\pm 100\%$  error, alternatively you may have evidence to demonstrate that the reliability of your prediction is very high and that your prediction has less than  $\pm 10\%$  error. Anyone in a decision making position needs to know this so they can weigh this into their cost benefit considerations.

Consider these two questions:

If you had demonstrable proof that model predictions were 99% reliable ( $\pm 1\%$  error) why wouldn't you use them?

If you had demonstrable proof that model predictions were 1% reliable ( $\pm 99\%$  error) why would you use them?

The crux of the matter here is really reliability! We must know how reliable our predictions are or we have nothing (Wiles 2006 and Wiles 2007).

Then how does one obtain reliable designs? The solution to this problem is the same tried and proven approach to design that all engineers use. The procedure used to establish the reliability is called "Terzaghi's Observational Approach to Design" (Terzaghi and Peck, 1967):

- Decide on some sort of initial mine layout - parametric studies.
- Begin mining.
- Monitor the rock mass response – normally visual.
- Redesign based on the observed behaviour - model calibration.

This process constitutes model calibration. Whether we use modelling or not, this is basically the approach we all use to design our mines.

Terzaghi's Observational Approach

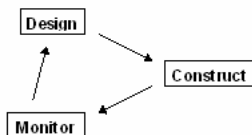

*Design on the basis of the most unfavourable assumptions is inevitably uneconomical, but no other procedure provides the designer in advance of construction with the assurance that the soil-supported structure will not develop unanticipated defects. However, if the project permits modifications of the*

*design during construction, important savings can be made by designing on the basis of the most probable rather than the most unfavourable possibilities. The gaps in the available information are filled by designing during construction, and the design is modified in accordance with the findings. This basis of design may be called the observational procedure.*

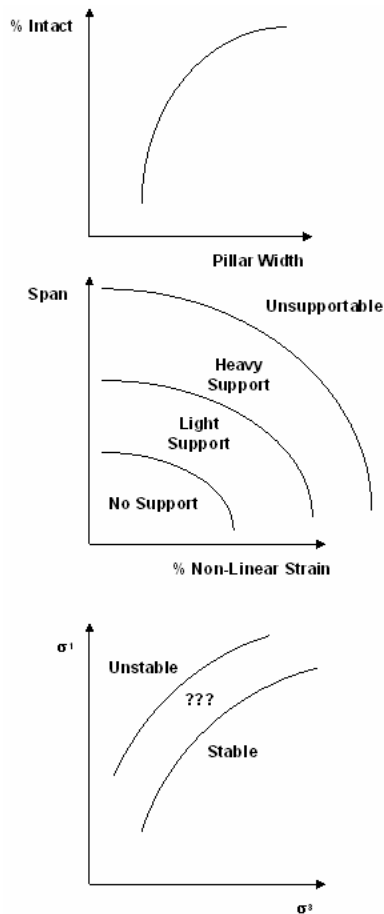

*In order to use the observational procedure in earthwork engineering, two requirements must be satisfied. First of all, the presence and general characteristics of the weak zones must be disclosed by the results of the subsoil exploration in advance of construction. Secondly, special provisions must be made to secure quantitative information concerning the undesirable characteristics of these zones during construction before it is too late to modify the design in accordance with the findings. These requirements could not be satisfied until the mechanics of interaction between soil and water were clearly understood and adequate means for observation were developed. Depending on the nature of the project, the data required for practising the observational procedure are obtained by measuring pore pressures and piezometric levels; loads and stresses; horizontal, vertical and angular displacements; and quantity of seepage.*

Although this text is dated, the ideas are sound. Applying these ideas to determining rock mass response predictions using numerical modelling leads to the following recommendations:

1) Be sure before you start that you are quite clear about why you are building a model and what questions you are trying to answer. Hypothesize possible modelling results and decisions that will be taken as a result. If you cannot make these decisions before you model, you likely will not be able to make them after you model. Some examples of how this might be approached are as follows:

- Pillar width will be selected based on maximum of 50% yielding across the cross-section of the pillar.
- Backfilling must be completed before 10% dilution is predicted.
- Ground reconditioning will be required when non-linear deformations exceed 1% strain.
- Long term ground instability will occur when elastic over-stressing exceeds 1.6 times the strength.

2) Use the model at the earliest possible stage in a project to generate both data and understanding. Models can often be used to help you understand what is going on.

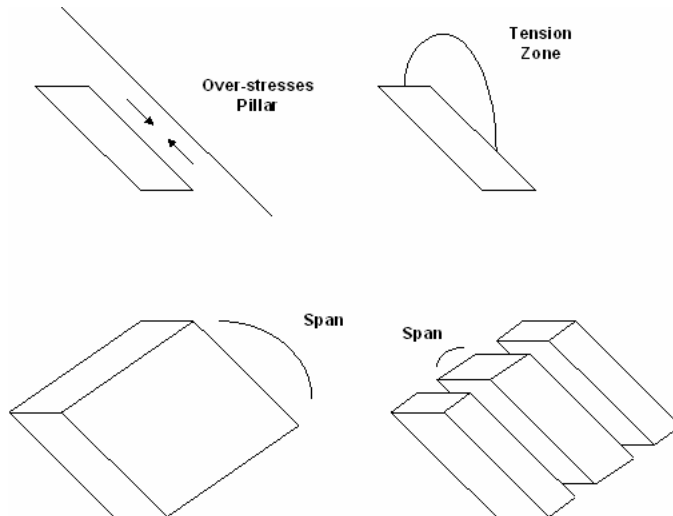

3) Look for the controlling mechanics of the problem. Try to identify important mechanisms, modes of deformation and likely modes of failure. Use the model to conduct "numerical experiments" to clarify conflicting ideas about what is going on in the field. Some examples of controlling mechanics are as follows:

- Compressive yielding of the hangingwall pillar formed between stopes and hangingwall fault is the cause of the dilution.
- Lack of confinement of the hangingwall is the cause of the dilution.
- Excessive span is the cause of the dilution.

4) Use the simplest possible model that will allow the important mechanisms to occur (2D, 3D, elastic, plastic, faults, water, heat, dynamics etc.). Implement this model and verify that it either ties in with your expectations, or if not, identify the weakness (in the model, or in your expectations) and adjust.

- Although two-dimensional analysis may be applicable early in the mining at very low extraction ratios, and late in the mining at very high extraction ratios, three-dimensional analysis is usually necessary.
- Slip on a weak fault may dominate the stress redistribution, thus requiring the use of fault slip simulations.
- Pillar yielding may be responsible for significant stress redistribution, thus requiring the use of non-linear analysis.

5) Once you have learned all you can from simple models, you may want to run more complex and detailed models to refine accuracy and explore those neglected aspects of the geology and rock mass response in the simple models.

6) Develop simple trends from the results to be used for design purposes. Assess sensitivity of these trends to various parameters assumed in the model. Statistics may be useful here in defining the reliability of the predictions. Some useful trends, which could be presented, are:

- Dilution volume versus span.

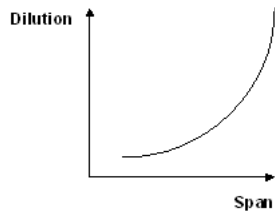

- % of pillar intact versus pillar width.

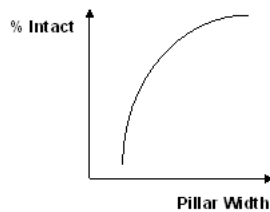

- Ground stability versus predicted stress state.

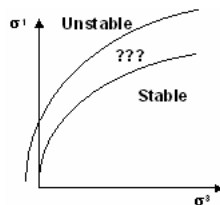

7) Monitor the rock mass response as the excavation progresses. Verify that the observed response agrees sufficiently well with the predicted results. Re-model is necessary as new information and understanding of the mechanics progress.

How well does this approach work?

The value of this approach is that as mining progresses, you learn how reliable (or unreliable) your model is. Note that traditionally observations of the rock mass response are made visually and often supplemented with sparsely located instruments. By making observations of rock mass response, over time you literally get to see when the model works and when it does not. You learn what features need to be included in the model (e.g. fault planes, lithology, loading conditions etc.). You not only learn how to use the model to predict rock mass response, but also gain confidence in the predictions and recognise situations where the model predictions are suspect.

In short you learn how reliable (or unreliable) your predictions are.

Once you have established the reliability, you are in a position to fine tune your design. A well calibrated model allows you a glimpse into the future: to predict how the rock mass will respond.

When properly applied, this procedure is extremely valuable. You can trim pillars and modify the design with confidence, leaving ore only where you need to. You avoid unexpected interruptions in production. You can mine with confidence.

To reinforce this concept let's consider a real example. Consider multiple violent pillar failures that occurred over several years of mining. For each failure, a numerical model was run to determine the

stress state at the time and location of the failure. If we plot all of these stress predictions on a set of  $s_1$  versus  $s_3$  axes we obtain the following:

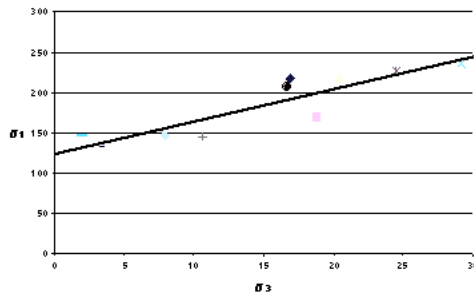

This figure illustrates that there is a strong correlation between the stress state at the time of each failure and a linear strength criterion. The coefficient of correlation of this data is 0.90. Let's state this in a different way. If you calculate the difference between the stress state for each pillar and the best fit line, then take the mean of these errors, you find that the mean error in prediction of  $s_1$  is approximately 17 MPa. This gives a coefficient of variation of only  $\pm 9\%$ .

It is evident that for this particular example that this approach can work very well: the stress state predicted from numerical modelling is a very reliable predictor for the time and location of pillar failures. Certainly, you would not expect pillars with stress states well below the best-fit line (more than 17 MPa) to fail. Also you would expect pillars well above (more than 17 MPa) the best-fit line to have failed at some previous mining step.

It is worth asking if this really is an application of Terzaghi's Observational Approach to design? Yes is fact it is. The mine operators tried many different modifications to the layout over the years of this study. The changes they tried were guided by the type of response they observed underground. Initially they found that although they could not avoid pillar failures, they could exert considerable control over when in the mining sequence this happened. In the end they found that by applying ground conditioning they could trigger the pillar failures at times that suited them best.

#### [Implementation of Modelling Into the Mine Design Process](#)

#### **What are the shortcomings of this approach?**

There are a few significant shortcomings to this approach. First of all, it takes many passes through the mine/monitor/redesign loop to learn how reliable the model predictions are. This takes time, manpower and continued dedication (a lot of trips underground). Monitoring the rock mass response is no trivial task. It may take several years before you establish the reliability with any confidence. Only you can decide if the effort can be justified, i.e. it is worth following through on this.

There are other less obvious limitations. There may be geologic features that cannot be adequately characterized for modelling. For example, often the details of the location, shape, extent and condition of various faults are not well enough known to be included in a numerical model with any accuracy. Exclusion of such features can invalidate the model results. Through proper application of Terzaghi's Observational Approach to Design you can establish that there is no reliability in the model predictions, and be left with an unpredictable situation (at least unpredictable as far as your existing model is concerned). "Geology in: geology out"

Finally, if local conditions such as pre-mining stresses, lithology or jointing vary rapidly from place to place it may be impractical to monitor with sufficient resolution to identify the effects of such changing features. There are modelling examples where these changing conditions have been taken into account. The resulting stress analyses produced predictions with remarkable agreement to the observed deformations. In these cases at least, this demonstrates that the variability in results is due

to changing local conditions, not due to model error.

This type of variation is normally not taken into account and shows up as large scatter in your predictions thus reducing you reliability.

While Terzaghi's Observational Approach is sound, it may only serve to demonstrate the lack of reliability you really have.

Clearly we would like to find a way around these problems:

- We would like to shorten the calibration loop.
- We would also like to be able to characterise geologic features well enough for incorporation into numerical modelling.
- Finally we would like to reduce scatter and develop a model with high reliability.

How are we going to improve on these shortcomings? One promising avenue of research is integration of numerical modelling with seismic monitoring [Map3Di](#).

## 1.8 Implementation of Modelling into the Mine Design Process

The only way numerical modelling will be fully implemented into the mine design process is if evidence of correlation between modelling results and rock mass response is demonstrated through case studies. To be of real value, the results from the numerical model must be directly related to rock mass response. This is best approached from three distinct points of view:

- parameters that are relevant to mine operators;
- physical aspects of rock mass behaviour; and,
- results from numerical modelling.

Rock response related characteristics, which have an important influence on mine design decisions must be identified and specified from an operating point of view. It is necessary to specify what parameters are of critical importance in decision making, and how these parameters actually come into play in the mine design process. Although it will be fairly easy to list these parameters, it will be much more difficult to define exactly how to use this information. Some examples could be:

- level of ground stability,
- stand-up time,
- risk of ore loss,
- level of ground support required.

The rock mass response must be characterized in terms of parameters, which can be directly measured underground, for example:

- level of joint alteration,
- displacement,
- strain,
- closure,
- stress change,
- but also in terms of parameters which are more subjective such as:
- ground support integrity,
- level of stability or amount of ground deterioration.

The rock mass at each mine site of interest must be characterized by use of scan line surveys and point load strength tests. Additional information in the form of displacements and strain

measurements (extensometers and closure points) as well as stress change monitoring (CSIRO cells or IRAD gauges) should also be used where appropriate.

This work is very important because it provides a repeatable, objective measure of current ground conditions. By continuing to monitor the rock mass conditions in this way, a record of when and where conditions change is made. This not only permits one to compare different sites to one another, but also to develop a direct method to relate in situ ground conditions to measurable, physical parameters.

The specific numerical modelling results, which can be used to relate directly to the rock mass response, are strain, displacement, stress, safety factor and size of failed zone. In order for these predictions to be reliable, it is necessary that extensive calibration and back-fitting of input parameters (far field stress, mechanical rock properties, and rock strength properties) be conducted. This work can only proceed when the physical aspects of rock mass behaviour (discussed above), are characterized adequately.

The three items: response characteristics specified by the operators, the observed rock mass response, and results obtained from numerical modelling, must all be correlated to provide reliable predictive capability. Concrete relationships between predictions, measurements, and the parameters that are relevant to the mine operators must be developed. One must be able to reliably correlate for example, the amount of joint alteration with the level of ground stability.

Demonstrations will be necessary so that operators can get a feel for how reliable (or unreliable) the predictions are, and how seriously they should take these predictions. Several different methods should be pursued simultaneously so that over time, the most important and reliable indicators can be identified and verified. Note that the reliability will change with time as rock mass response characteristics are collected.

It is very important that the far field stress state be established with some confidence. The orientation can often be determined by observation of ground response (i.e. fault slip direction, micro-seismic event locations, ground stability dependence on orientation, dominant closure direction, spalling etc.). An active effort to compile this form of evidence should be undertaken. Direct measurements by over-coring or some other technique are often necessary (Wiles and Kaiser, 1994).

The most important deformation properties to be concerned with are the stiffness of the rock mass, and its inelastic response during yielding. These parameters are the key to making accurate displacement and strain predictions. A best guess estimate for stiffness can be made by use of rock mass rating (Hoek and Brown, 1988). However, it must be recognised that this is only an estimate, and it is necessary to further fine-tune the model.

It is important to distinguish between the actual elastic portion of the ground response, and the total response, which is a combination of the elastic deformation and non-linear yielding effects such as joint alteration. At a large distance from openings, one expects ground deformations to be primarily elastic, where-as near the excavation surfaces, or in yielding pillars, one expects a large part of the deformation to be inelastic, and highly dilational in nature.

Although the rock mass strength can be estimated by use of a rock mass rating (Hoek and Brown, 1988), laboratory compressive tests and point load test results are also very useful in this characterisation. Just as for stiffness however, it is necessary to fine-tune the strength parameters to the actual in situ response. This can only be achieved by use of parametric studies where one attempts model calibrations by trial and error for numerous different cases. With time, sufficient examples will be compiled to define a strength envelope, which is truly representative of the rock mass under study.

It should be mentioned here that both the far field stress and mechanical properties will influence model results, therefore, before any parametric studies are conducted, the best possible information



must first be obtained for the former parameters. As better far field stress information and mechanical property information becomes available, strength parameters will have to be re-evaluated for accuracy, and adjusted to suit the new information.

This discussion is by no means complete, however it is presented here to give users a start on developing their own scheme for using modelling. In summary:

- Efforts should be made to clearly define the objectives of the modelling along the lines of providing operations with reliable ground control and ground stability predictions. All efforts should ultimately be directed towards achieving this objective. A plan should be put in place on how these objectives are to be achieved with the resources available.
- A ground stability reporting system should be established to systematically observe, document and report on ground control related problems. This should include a discussion on how the observed ground control problem could (or could not) be identified with instrumentation, numerical modelling etc., and controlled by use of modified sequence, layout or ground support. The underlying mechanism or cause should also be identified where possible. Implications with regards to important parameters defined by operations should be addressed, e.g. level of ground stability, stand-up time, risk of ore loss, level of ground support required etc. This reporting system can be used as a forum for communication and education on the use of instrumentation, numerical modelling and rock mechanics principles as applied to mine stability.
- When modelling, one should always test for very specific problems and conditions. Through a process of back-analysis, one can identify what stress states or stress paths lead to know problems underground. Some ideas on how to do this are presented in Figure 3. After many back-analyses have been completed, one will have a good feel for the confidence that can be placed in the predictions. This confidence level may be very good or very poor, but it must be established. Once these have been identified, one can then attempt to make predictions with know reliability.
- Some form of routine monitoring should be implemented (e.g. visual, scan-line, closure, ground movement monitors, extensometers and stope outlines). Scan-lines can be repeated at the same location as ground conditions deteriorate as a quantitative log of ground response. These items can be directly related to mining problems and numerical modelling results.

**Map3D  
User's Manual**

**Part**

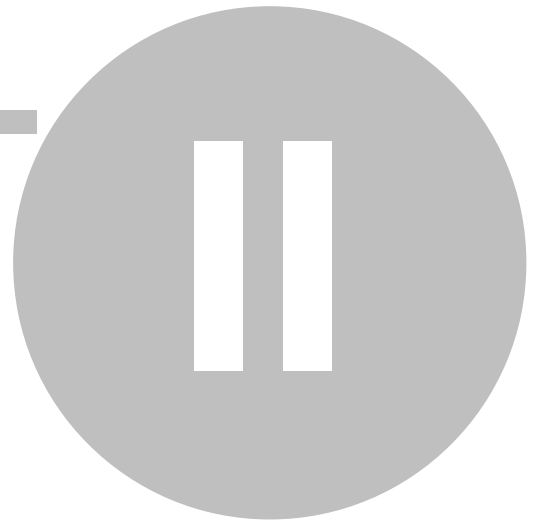

## 2 Model Building and Editing

### 2.1 Model Building and Editing

[Building Surface Models](#)

[Building Models Out of Blocks](#)

[Constructing Alternate Material Zones](#)

[Material Codes - Mining Step Sequence](#)

[Defining Ground Surface](#)

[Defining Open Pits](#)

[Defining Fault Planes and Tabular Mining Zones](#)

[Defining Inactive Blocks for Visualization Purposes](#)

[Common Problems when Model Building](#)

### 2.2 Building Surface Models

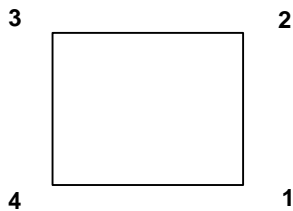

Models can be built out of individual surface patches.

 [CAD > Build > Block](#)

 [CAD > Build > DD Loop](#)

These are defined by 3 or 4 sided polygons that need not be planar. The corners can be entered in either clockwise or counter clockwise orientation. Any of the corners can be repeated to define 3 sided shapes and wedges.

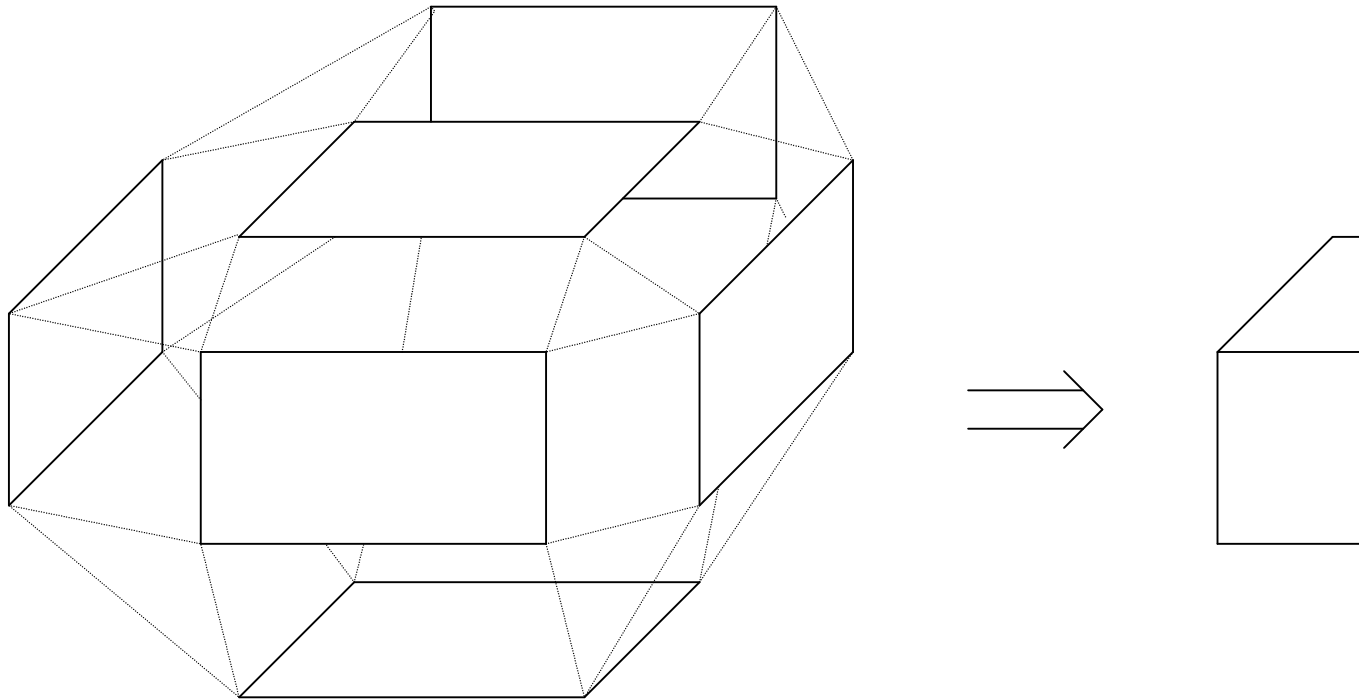

Surface patches can also be used to construct excavation surfaces and complex ore outlines if desired. The

 [CAD > Build > FF Loop](#)

routine can assist you in constructing complex as-built layouts with ease. The routine works by tracing around multiple level plans or sections, then automatically linking them together.

This is often the best approach, particularly when attempting to construct as-built models of structures where the exact shape is well known. This approach is useful for very detailed analysis of many civil type structures where stress concentrations and assessment of local instabilities are of primary concern.

These shapes can be constructed using the CAD functions built into Map3D or can be imported from other CAD packages in either

- [AutoCAD-DXF](#) format. This is a popular drawing exchange file with the extension ".DXF".
- [Point file format](#) is a universal ASCII data file with the extension ".PNT".

Even for simple shapes, this construction procedure can quickly get out of hand. Since it is necessary to create a series of surface patches that when taken together, form a seamless, non-overlapping, continuous skin, one cannot leave gaps or holes.

When models are built in this way, Map3D checks that closed surfaces are formed

[Analysis > Options > Closure](#)

Also, all surfaces will be renumbered in a consistent manner to ensure that they create positive volumes

[Analysis > Options > Renumber](#)

This renumbering may fail if surfaces are unclosed, i.e. there are holes in the excavation due to

missing portions.

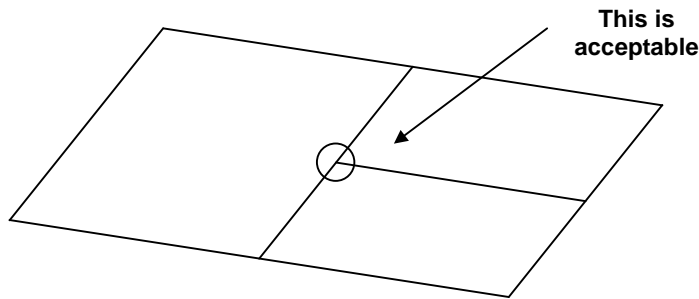

Unlike other analysis programs (isoparametric boundary element methods and the finite element or finite difference methods), it is not necessary that these plates share common corner points. Users are free to define elements with subdivisions mid-way along their edges, provided no gaps exist. Although models can be built using this surface modelling technique, an easier and more reliable technique is to use solid modelling

[Building Models Out of Blocks](#)

## 2.3 Building Models out of Blocks

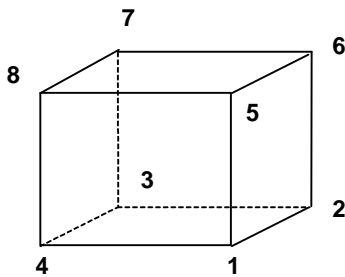

For many problems the details of the exact shape of excavation surfaces is not important since one is looking for a more global assessment of stability, such as pillar, abutment or hanging wall conditions. Since it is very tedious to describe the location and connections for every surface, in Map3D models can also be assembled out of three-dimensional building blocks.

 [CAD > Build > Block](#)

 [CAD > Build > DD Loop](#)

 [CAD > Build > FF Loop](#)

These blocks are used for construction of three-dimensional excavations, alternate material zones and back-filled zones. They are defined by a top and bottom, each with 4 corners. The corners can be entered in either the clockwise or counter clockwise orientation, provided the top and bottom sides line up with one another (i.e. corner 5 must be opposite corner 1, 2 opposite 6, etc.). The sides do not have to be neither parallel nor planar and any of the corners can be repeated to define 3 sided shapes and wedges.

These blocks can be stacked together to create complex excavation shapes or ore zone boundaries. They are linked together either by sharing common corners or by virtue of the fact that they intersect. Sides, which are common to more than one block or penetrate other blocks are automatically cut off

and deleted. The volume contained within the block structure defines an excavation, ore zone, yield zone, backfilled zones, etc.

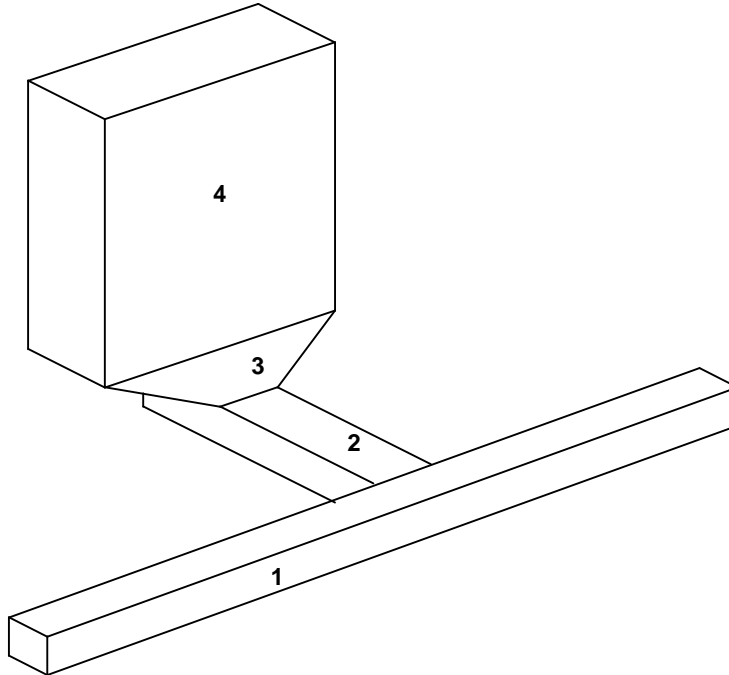

To illustrate this point, consider a simple drawpoint configuration, which has been assembled out of 4 blocks. Block 1 represents the extraction drift, block 2 represents the crosscut, block 3 represents the drawpoint, and block 4 represents the stope. The pre-processor in Map3D identifies the connections between these blocks, cuts them off and deletes the surfaces, which are common to adjacent blocks.

## 2.4 Constructing Alternate Material Zones

Models, which use multiple materials, are built using similar principles as normal excavation type models. Instead of defining the interior of a block as excavated (i.e. material code zero), one simply specifies the number of the material that exists inside the block.

By default, the host material is material number 1. Any region, which has a different set of properties (initial stress, elastic response or strength), must be defined just as an excavation would be defined using Fictitious Force type boundary elements. Instead of assigning these blocks a zero (to indicate zero surface stresses) or negative material code number (to indicate some specified stress state), they are simply assigned a positive material code number to indicate the properties to be associated with each particular group of blocks.

Recall that complex excavation shapes are built by combining several blocks with the same block number together to form the desired shape. In exactly the same manner, separate regions each with a different set of material properties, are formed by building the desired shape out of many blocks, which have the same block number.

An important consideration here is that as few as possible block numbers should be used since all surfaces between groups of blocks with differing block numbers will be maintained in the database.

There are two methods of defining regions which are to be assigned material number 2 or higher (i.e.

a different material number than the host material).

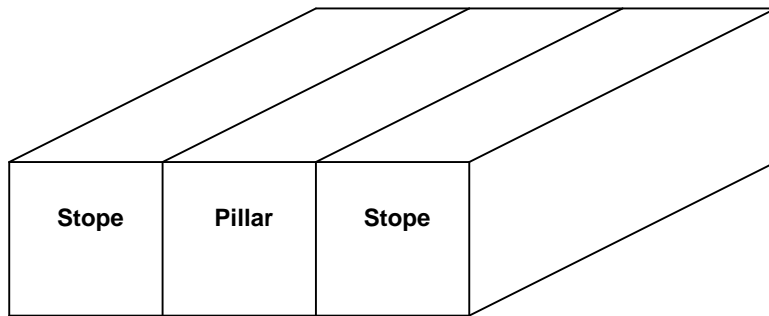

In the first method, regions with a different material numbers are constructed out of blocks, which appear exactly as excavations do.

This technique is useful for defining details of, for example, soft modulus zones around the periphery of excavations. This is also the best method of defining isolated features such as stiff dykes or blast damaged pillars.

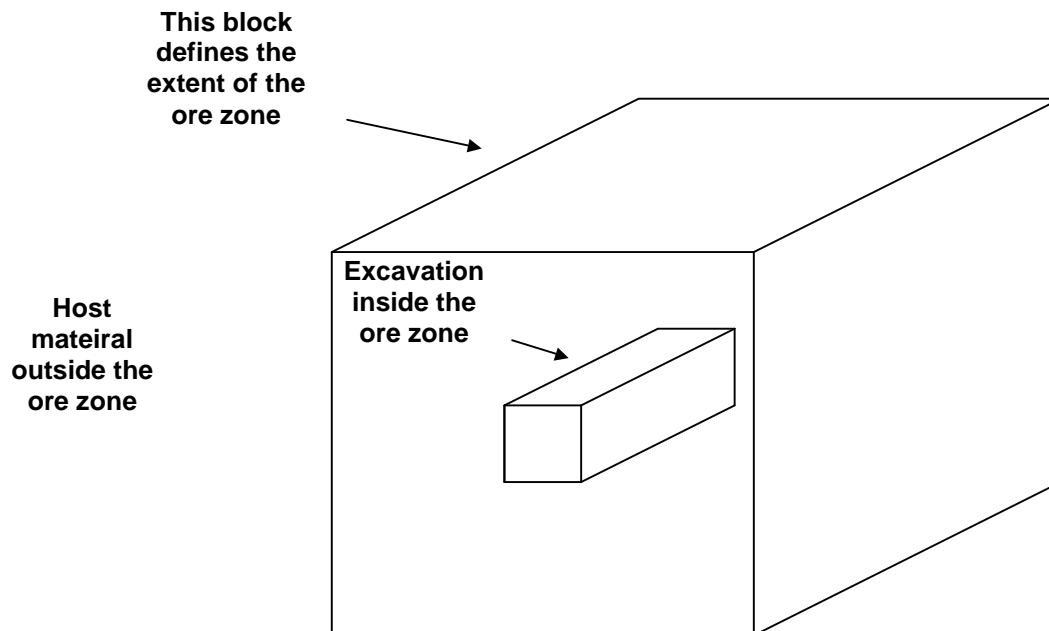

The second method of defining regions is a more global approach where an entire excavation system (or part of it) is enveloped in a set of blocks, which define for example the ore zone. It is permissible to enclose one envelope with another (i.e. like an onion skin), and to overlap envelopes. Drifts, for example, are permitted to protrude through the ore zone into the host rock mass. Map3D constructs the required intersections.

These two methods can be used simultaneously. It is permissible to use blocks that define a global region using the second method. These blocks can either completely or only partially envelop other excavations defined using the first method.

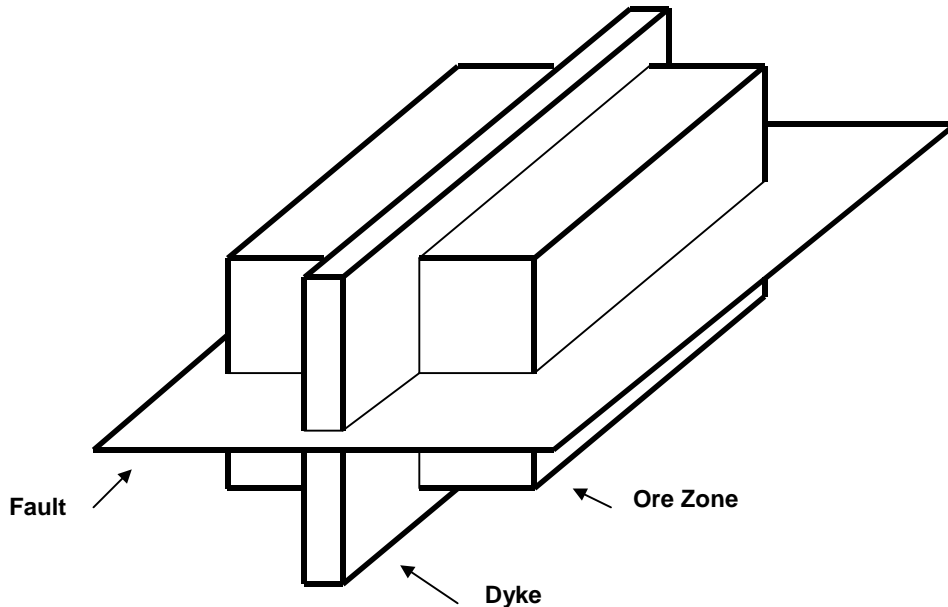

The only consideration, which must be strictly observed when defining multiple material zones, is the convention that higher material numbers take priority over lower material numbers. This convention has been adopted to overcome the ambiguity when considering the intersection of two different features such as a fault with a dyke. When a fault and a dyke intersect, it is not clear whether the fault should be assumed to persist through the dyke or visa versa. Another example is the case where a dyke intersects an ore zone. Should the dyke be assumed to be persistent and cut through the ore, or should the ore be assumed to be persistent and cut off the dyke.

In either of these cases, it is the feature, which is assigned the higher material number, which is persistent. If the fault was assigned material number 4, the dyke assigned material number 3, and the ore assigned material number 2, the fault would persist throughout. Because it has the highest material number, the fault would be continuous though the ore and through the dyke, but not through excavations of course. Since the ore has the lowest material number, it would not cut through the dyke, but rather the dyke would cut through the ore.

You can use the following hide functions to assist in resolving which material cuts through other materials:

 [View > Hide > Solids](#)  
 [View > Hide > Unused](#)

Logic has been built in to support the intersection of up to five features simultaneously (i.e. the intersection of blocks with five different block numbers). An unlimited number of blocks may intersect, but a maximum of five can only intersect at the same location. This will permit specification for example of multi-layer ore zones, with excavations on either side of the contact, and a fault running along the contact. Map3D automatically detects blocks which are partially or totally enclosed within other blocks, and blocks which are adjacent to other blocks thus permitting a practically unlimited number of regions with different material types to be considered in any analysis.

When viewing the excavation geometry in graphics mode, the user can move the mouse cursor over a block of interest. Upon pressing a mouse button, the block number and the block name will be displayed. Also, the material code assigned to that block and the material code of the region adjacent or enveloping that block surface will be displayed. For example, for block surfaces adjacent to the



host material, the "adjacent material code" will be one (recall material one represents the host rock mass). If the block surface is adjacent to an excavation, which has been assigned material code 2, and then the "adjacent material code" will be 2.

During the analysis, results are generated on field point grids. Map3D automatically detects whether grid points are located inside excavations or within regions with different material properties. When contour results are displayed, the user can move the mouse cursor over the field point of interest. Upon pressing a mouse button, the material code assigned to the region where that particular field point is located will be displayed along with the coordinates, displacements and stress state information. Note that strength factor calculations will be made using the material properties specified for that region. This feature permits assessment of strength, which may be different from one region to another.

## 2.5 Material Codes - Mining Step Sequence



The mining step sequence is specified simply by designating appropriate material codes at the desired mining step. The material code represents the number of the material that exists inside the block. By default, the host material is material number 1. Any region which has a different set of properties (initial stress, elastic response or strength) from the host, should simply be assigned a positive material code number to indicate the properties to be associated with each particular group of blocks.

**Material code 0** specifies that the element will have zero surface stresses. This is the default and is normally used for excavation surfaces, ground surface and open pit walls.

**Material code -M** (e.g. -2) specifies that the element will have surface stresses equal to the stress state associated with material number M. This is useful for modelling pressurized openings or stresses that vary with depth (e.g. backfill).

**Material code +M** (e.g. 2) specifies that the enclosed region will behave with the properties associated with material number M. This code is used to specify regions that have properties different from the host material (e.g. ore, dyke, backfill, etc.).

Material codes are assigned during model building using

-  [CAD > Build > Block](#)
-  [CAD > Build > DD Loop](#)
-  [CAD > Build > FF Loop](#)

Material codes can be assigned at any time using

-  [CAD > Edit > Entity Properties](#)

You will be prompted as follows

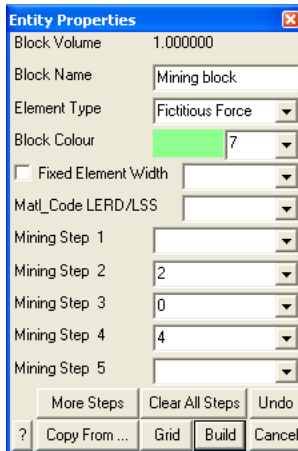

In this example, the selected block is not used at step 1. Assigned the properties for material number 2 at mining step 2. At mining step 3 the block is excavated. Finally at mining step 4, the block is backfilled with material number 4.

This procedure can be used with fictitious force type elements to define three-dimensional zones with different stresses and material properties (e.g. stiff dykes, soft ore zones or yielding zones). It can also be used with Displacement Discontinuity type elements to define planar zones with different stresses and material properties (e.g. gouge filled faults, tabular mining yielding pillars).

The material codes can be specified a different value at each mining step. If no material code is assigned (i.e. the material code is left blank), the block will remain inactive.

It is important to remember the convention that higher material numbers (material codes) take priority over lower material numbers. This convention has been adopted to overcome the ambiguity when considering the intersection of several different features such as a fault with a dyke, or backfill placed in part of a stope. To ensure you will not have problems it is advisable to use the highest material numbers for backfill.

When simulating stiff support systems such as arches, steel sets, props, thick liners, chinks, strong backfill etc., it is necessary to model the ground movement up to the point of support placement, then insert the support elements either in a stress/strain free state, or with a prescribed pre-stressing. To accomplish this you must first excavate the desired support element (either a 3D FF block or DD plane) to the desired pre-stressed state (use a zero material code for zero stresses or a negative material number for a prescribed stress state), then in a subsequent mining step insert the support material (use a positive material number to do this). With the [Analysis > Options > Zero Strain Support Placement](#) option checked, Map3D conducts the necessary calculations to place support elements in a stress/strain free state or with a prescribed pre-stressing at the current mining step. The action of excavation to a zero or prescribed stress state followed by insertion of an alternate material signals Map3D to conduct the required calculations.

This procedure is particularly useful for simulation of structural support elements and can accommodate placement, modification of properties and subsequent removal if desired. This option has been enabled for use with 3D FF blocks and/or DD planes.

Without this option, all materials are placed at the pre-mining deformation state. This can cause erroneous large stresses particularly in stiff support elements.

The mining sequence achieved can be viewed while in Map3D graphics mode simple by flipping between mining steps using

Step File > Mining Step

## 2.6 Defining Ground Surface

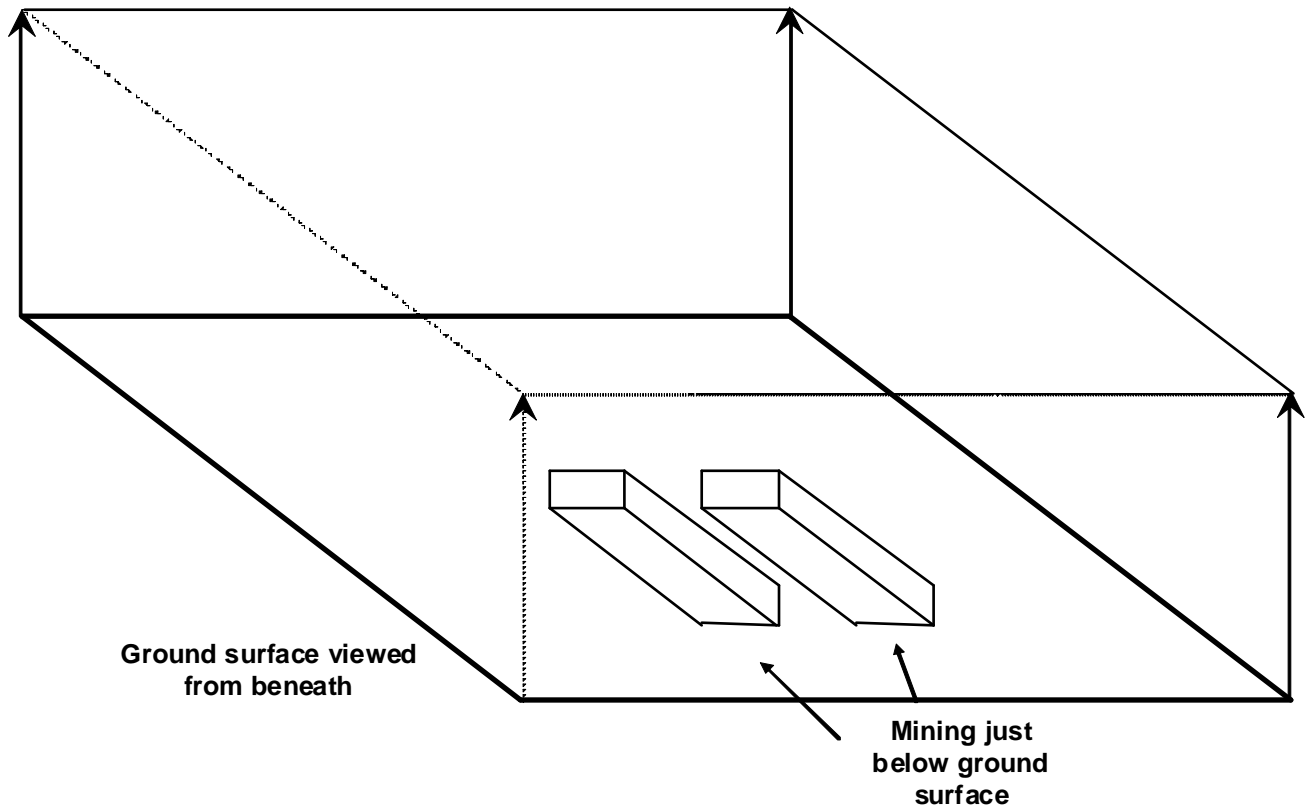

Ground surface is best defined using a large FF zone with its lower surface as the ground surface. By assigning a material code of zero to these elements, Map3D will ensure zero normal and shear stresses along these surfaces thus simulating a free surface.

It is only necessary to define ground surface when your mining excavations are fairly shallow, (i.e. the depth of mining is less than approximately twice the lateral extent of the mining). For these cases, the free surface should extend at least twice the lateral extent of the mining in all directions.

The user should not extend field point grids near or through the free surface unless absolutely necessary, since this will result in the discretization of the free surface into a large number of boundary elements.

## 2.7 Defining Open Pits

Although open pits can be built using Displacement Discontinuity elements, this is not recommended. Open pits are best handled when constructed as excavations (using block definitions with Fictitious Force elements) adjacent to ground surface. This is because the intersection logic built into Map3D

can detect the interior of excavation blocks and cut off any intersecting features (such as faults, ore zones or drifts). Also, displacement discontinuity elements, which lie along the edge of an excavation (for example ground surface), will also be detected and treated properly.

This same logic does not exist for zones defined by displacement discontinuity elements. The user could easily construct a model with multiple overlapping displacement discontinuity elements, which will not converge.

## 2.8 Defining Fault Planes and Tabular Mining Zones

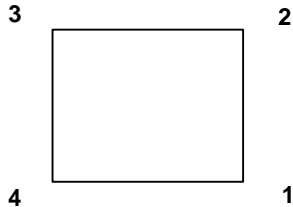

Models can be built out of individual surface patches. These are defined by 3 or 4 sided polygons that need not be planar. The corners can be entered in either clockwise or counter clockwise orientation. Any of the corners can be repeated to define 3 sided shapes and wedges.

 [CAD > Build > DD Loop](#)

These shapes can be constructed using the CAD functions built into Map3D or can be imported from other CAD packages in either:

- [AutoCAD-DXF](#) format. This is a popular drawing exchange file with the extension ".DXF".
- [Point file format](#) is a universal ASCII data file with the extension ".PNT".

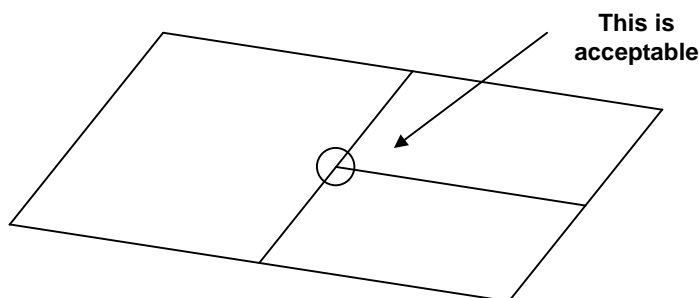

Unlike other analysis programs (isoparametric boundary element methods and the finite element or finite difference methods), it is not necessary that these plates share common corner points. Users are free to define elements with subdivisions mid-way along their edges, provided no gaps exist.

Fault planes and tabular mining are built using the same principles as normal excavation type models. These features are simply specified along with other excavations and multiple material zones, and can be used simultaneously with all other Map3D features.

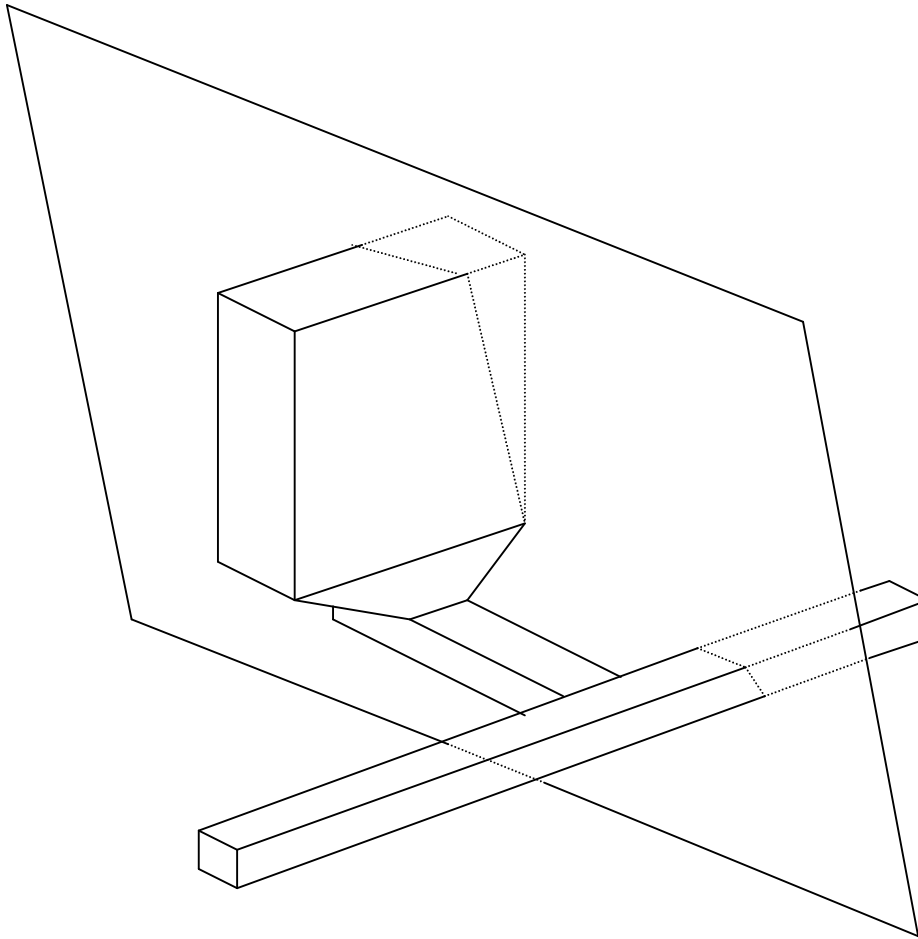

Fault planes and tabular mining zones are defined using displacement discontinuity elements. These can only be specified in terms of plate definitions. The four corners of the plate define the extremities of the displacement discontinuity. Displacement discontinuities can intersect excavations at any location, since Map3D builds edge intersections internally.

As in the section above, the only consideration, which must be strictly observed when defining fault planes, is the convention that higher material numbers take priority over lower material numbers. When considering the intersection of two different features such as a fault with a dyke, it is the feature that has been assigned the higher material number that will persist through the other.

A concern, which must be addressed when using non-linear modelling (whether fault slip or generalised yielding in Map3D Non-Linear), is that the far field stress should not exceed the strength. If the far field stresses exceed the rock mass strength, then the rock mass itself will be unstable. Although this may be admissible in some creep problems, it is generally not acceptable, and steady state (i.e. non-creeping) solutions are not possible.

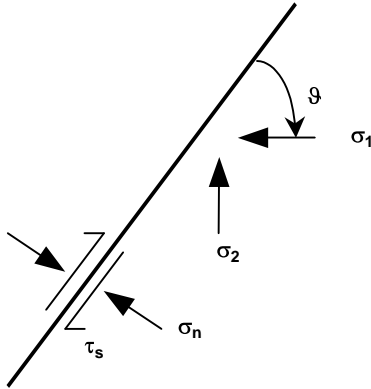

This limitation is more severe when simulating faults. Any fault may be at or very near static equilibrium (i.e. stresses equal to the strength) with the far field stress state. For weak faults under high stress ratios the principal stresses must be oriented almost perpendicular or parallel to the fault plane, otherwise the fault will be unstable, and slip even without any mining. This condition is generally not acceptable since steady state (i.e. non-creeping) solutions are not possible.

For the case where  $\sigma_1$  is oriented at the angle  $\vartheta$  from the fault plane, the shear stress and normal stress acting on the fault are given by

$$\begin{aligned}\tau_s &= (\sigma_1 - \sigma_2) \sin(\vartheta) \cos(\vartheta) \\ \sigma_n &= \sigma_1 \sin^2(\vartheta) + \sigma_2 \cos^2(\vartheta)\end{aligned}$$

substituting these into the shear strength relation

$$|\tau_s| = \text{Cohesion} + \sigma_n \tan(\varphi)$$

it can be found that the stress state must satisfy

$$|(\sigma_1 - \sigma_2) \sin(\vartheta) \cos(\vartheta)| = \text{Cohesion} + [\sigma_1 \sin^2(\vartheta) + \sigma_2 \cos^2(\vartheta)] \tan(\varphi)$$

For example, with

$$\begin{aligned}\sigma_1 &= 32 \text{ MPa} \\ \sigma_2 &= 16 \text{ MPa} \\ \text{Cohesion} &= 0 \\ \varphi &= 10^\circ\end{aligned}$$

then  $\vartheta$  must be less than  $11^\circ$  or between  $69^\circ$  and  $90^\circ$ .

With

$$\begin{aligned}\sigma_1 &= 60 \text{ MPa} \\ \sigma_2 &= 16 \text{ MPa} \\ \text{Cohesion} &= 0 \\ \varphi &= 30^\circ\end{aligned}$$

then  $\vartheta$  must be less than  $15^\circ$  or between  $45^\circ$  and  $90^\circ$ .

## 2.9 Defining Inactive Blocks for Visualization Purposes

Often when building a model it is desirable to include details of the development headings for visualization purposes. This assists model interpretation since users can more easily identify familiar locations in the mine. While such detailed geometries can be included in the Map3D stress analysis, their presence increases the analysis time owing to the larger number of boundary elements required. Since small drifts normally only influence nearby excavations, the majority of these can be left out of the analysis without significantly influencing the results.

It is however, desirable to superimpose detailed drift locations on the analysis results to aid in visualization. Blocks can be included into the Map3D database but not included in the analysis, simply by assigning an inactive block type. These blocks will be excluded from the intersection, discretization and analysis portions of the code, and hence do not increase the computational effort.

## 2.10 Common Problems When Model Building

In this section a few common construction errors are described along with suggestions as to how to avoid and correct these problems.

Connecting a Cross Cut onto a Straight Drift

In this example, the crosscut is easily constructed by snapping its corners to the edge of the access drift. The "nearest edge" snap mode

 [CAD > Snap > Nearest Edge](#)

should be used to select the indicated points. The built-in Boolean intersection capabilities of Map3D will automatically create the intersection between the two blocks during stage 2 of the analysis. This construction will work fine.

While for simple geometries this works fine, in many situations this connection is not so straightforward.

Let's consider a more complex geometry where the segments of the footwall access drift do not line up with the desired locations of the crosscuts.

### Connecting a Cross Cut onto a Complex Drift

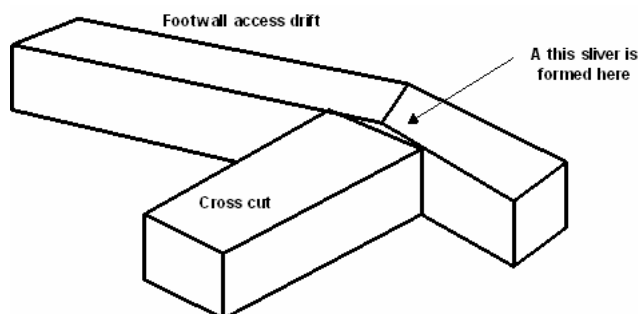

In this example, the crosscut does not join onto the footwall access drift correctly. A thin pillar is formed at the end of the crosscut. Map3D will detect this pillar and attempt to analyze it, probably without success. Just as this feature would be in reality physically unstable, it is also unstable

numerically. Map3D can actually conduct a successful analysis of this feature, but only if the adjacent faces of the pillar are discretized with boundary elements of size similar to the pillar thickness. However, this is not a desirable approach since it would require a large number of elements and this pillar does not actually exist.

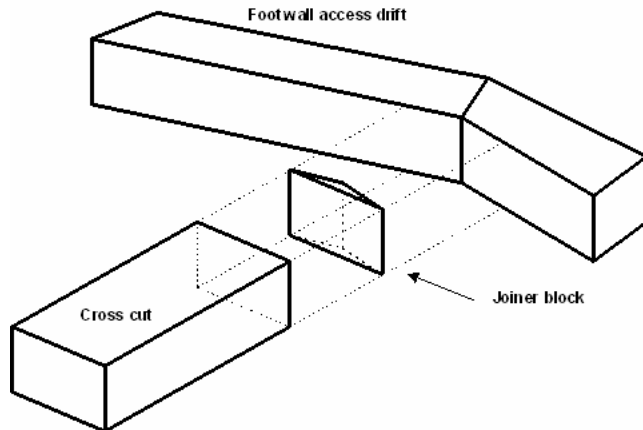

In order to avoid this problem, an additional joiner block could be built as shown in the adjacent exploded view. The "nearest corner" snap mode should be used so that this new block will join onto the drift and cross cut properly. This joiner block effectively mines out the undesired pillar thus properly connecting the cross cut to the footwall access drift.

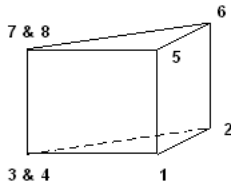

Note that the joiner block has only three points around the top and bottom. This can be readily constructed by selecting one of the corners twice at the same location (e.g. points 3 & 4 and 7 & 8).

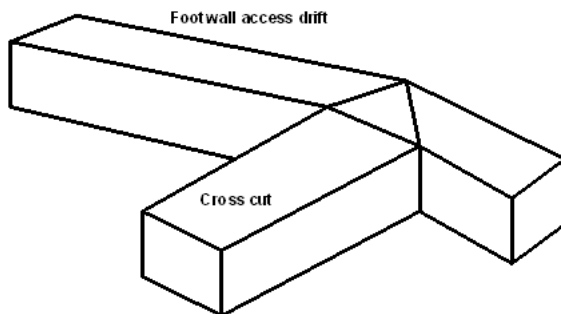

This problem can be avoided entirely if we construct the segments of the footwall access drift such they line up with the desired locations of the cross cuts. This is easily accomplished by subdividing the footwall access drift as shown. Often some for thought will help in easing the difficulty of construction.

### Connecting Miss-Matched Stopping Blocks



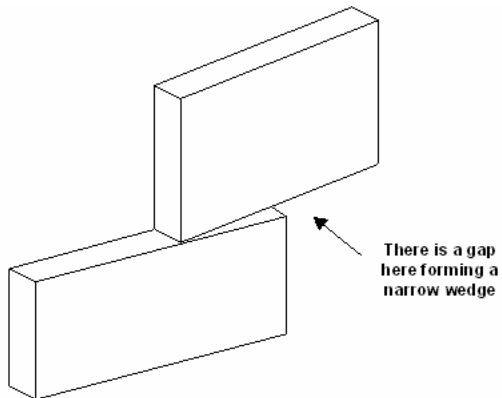

Often the situation arises where multiple stopping blocks must be joined along their common edges.

In this example, if the bottom of the upper block and the top of the lower block were at the same elevation, the built-in Boolean intersection capabilities of Map3D would automatically create the intersection between the two blocks during stage 2 of the analysis. This construction will work fine.

The problem occurs during construction when one attempts to snap the corners of one block to join along the side of the other. In this example, the upper block has been snapped onto the top edge of the lower block leaving a gap.

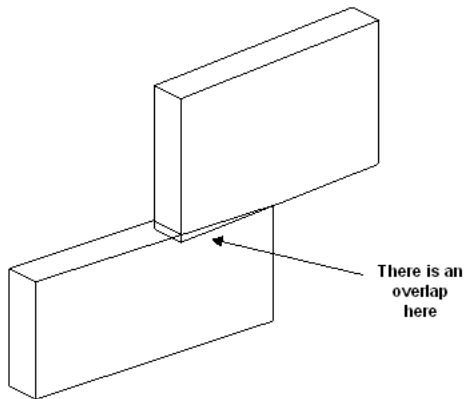

In order to eliminate this gap, one could snap the corners of the lower block onto the bottom edge of the upper block using the stretch function. But this will create an overlap, and hence does not fix the problem.

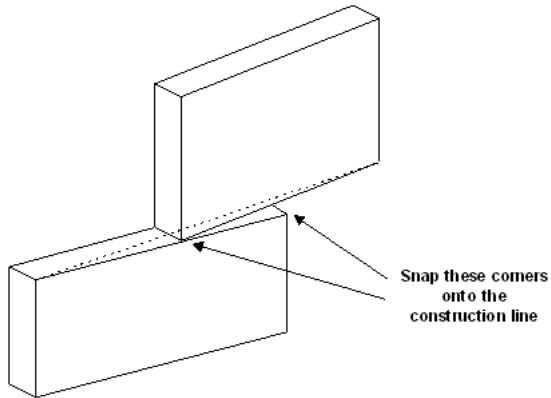

The alternative is to create a joiner block as described above. However, a simpler alternative is to create a construction lines that spans the problem area and snap corners from the upper and lower block to these lines. This procedure would have to be completed for both the back and front faces of the stopping blocks.

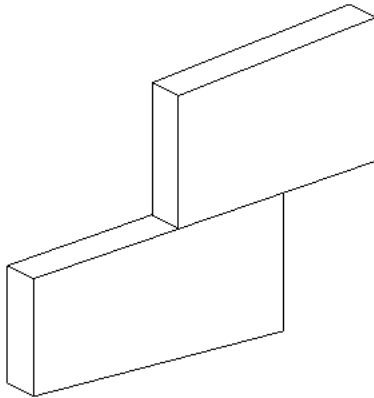

This method has the draw back that it does alter the shape of the stopping blocks, possibly in undesirable ways.

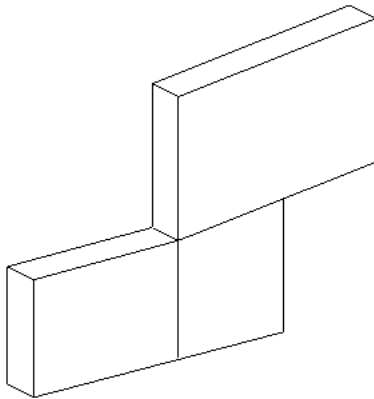

The best alternative is probably to subdivide one or both of the stopping blocks. This is the most effective technique for eliminating gaps and joining miss-fitting blocks.

### **Connecting Offset Stopping Blocks**

Often the situation arises where the shape of one stopping block does not match the adjacent stopping block.

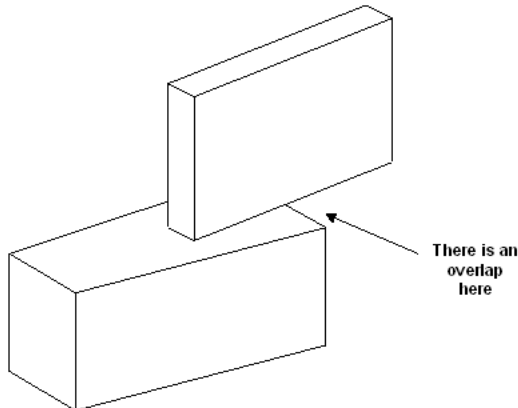

This situation can be easily accommodated by the built-in Boolean intersection capabilities of Map3D. The program will automatically create the intersection between the two blocks during stage 2 of the analysis.

These routines work best if all points on the bottom side of the upper block and all points on the topside of the lower block are at the same elevation. This can be achieved using

 [CAD > Edit > Move Vertices to Z](#)

The routines will even work if the bottom side of the upper block and the topside of the lower block are non-planar and at different elevations as long as they do in fact intersect one another. In this latter case however, the resulting intersection may contain many complex elements. While these shapes will work fine, they could slow the analysis down owing to their large number and the fact that often they must be discretized heavily.

### Connecting A Drift to a Stopping Block

Often the situation arises where one wants to intersect a drift with stopping block.

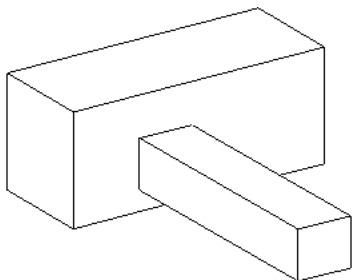

As above, this situation can be easily accommodated by the built-in Boolean intersection capabilities of Map3D. The program will automatically create the intersection between the drift and the stopping block during stage 2 of the analysis.

These routines work best if the intersecting faces are planar and parallel. The routines will even work if the intersecting faces are non-planar and non-parallel as long as they do in fact intersect one another. In this latter case however, the resulting intersection may contain many complex elements. While these shapes will work fine, they could slow the analysis down considerably owing to their large number and the fact that often they must be discretized heavily.

## 2.11 Discretization and Lumping

Map3D uses several different, but complimentary strategies to permit analysis of very large problem sizes. Discretization is controlled such that boundary elements are only used in locations where they are needed. Several forms of lumping are then used to reduce analysis time and disk space requirements. Together, these features enable Map3D to accommodate very large problem sizes (more than 333333 elements) on PC platforms.

Without lumping, a 64000 element problem would take 147 GB of disk space. With lumping, this can be reduced to less than 1 GB. The time required for analysis reduces by approximately the same proportion. This permits users to specify existing mining geometry in detail, and add new mining as required. This greatly reduces the effort required to set up and run analyses and permits the whole mine to be considered when necessary.

All discretization and lumping parameters are expressed in terms of a distance over length ratio. In all cases the distance is measured between two points of interest (e.g. from one element to another, or from an element to the nearest grid point). In this ratio, the length is the size of the element, or grid spacing at one of the points of interest.

Suggested values for the discretization and lumping parameters are as follows:

- **AL** should be set equal to twice the smallest pillar or stope width. Use the same units used to specify the coordinates (e.g. metres or feet).
- **AG** should be set equal to the smallest dimension of interest. Use the same units used to specify the coordinates (e.g. metres or feet).
- **DON=0.5, DOL=DOC=1, DOE=DOG=2** for 10-20% error
- **DON=0.5, DOL=DOC=2, DOE=DOG=4** for 5-10% error
- **DON=1.0, DOL=DOC=4, DOE=DOG=8** for < 5% error

The details of the use of these parameters for control of discretization and lumping are described below.

### **DON and AL - Matrix Conditioning**

During the discretization process all model surfaces (surfaces of FF blocks and DD planes) are subdivided into boundary elements with side length

$$Lelem = Delem/DON$$

where *Delem* is determined by Map3D as the smallest distance between adjacent model surfaces. Since at some locations the distance *Delem* may be zero, the minimum element side length **AL** must be specified.

**AL** should be set equal to twice the smallest pillar or stope width. The same units used to specify the coordinates should be used (e.g. metres or feet).

A value for **DON** of 0.5 is generally adequate for all problems except those with very narrow excavations or pillars. In this latter case a value for **DON** of 1.0 is recommended.

Although higher values of **DON** results in generation of more boundary elements and hence longer run times, this is necessary to obtain a well-conditioned solvable problem for very narrow excavations or pillars.

**DON** controls the way block surfaces are discretized into boundary elements. This parameter along

with *AL*, is used to ensure that a well-conditioned, solvable coefficient matrix will be generated by the Boundary Element Analysis.

Matrix conditioning can be directly related to the magnitude of *DON*. A well-conditioned, easily solved matrix can be guaranteed by using larger values (near one) of *DON*.

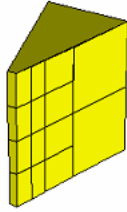

*DON* = 0.5

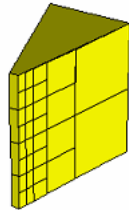

*DON* = 1.0

These parameters control how fine the discretization will be for surfaces, which pass near one another. For example comparing examples using *DON* of 0.5 and 1.0, it can be observed that larger values of *DON* produce smaller boundary elements where the slope is locations.

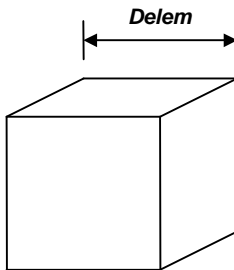

From an analysis point of view, there are three basic types of problems. The easiest to solve are problems, which use bulky, three-dimensional shapes such, that surfaces are spaced well apart.

For this type of problem, a well-conditioned coefficient matrix will always be generated, and the effect of *DON* and *AL* are not important.

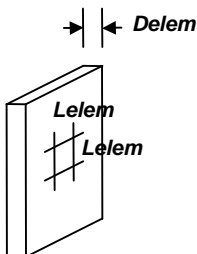

The next most difficult type of problem to solve is one where narrow stopes are defined. For this case, the distance *Delem* (which is the smallest distance from one element to another) is just the stope width. Since the element side length *Lelem* can be calculated from the *DON* ratio as

$$Lelem = Delem / DON$$

such that *Lelem* is not less than *AL*, small values of *DON* will generate small elements only near locations where stopes are narrow. As one moves away from these areas, the element size will very quickly increase. The use of fictitious force elements to create this type of tabular shaped excavation can result in a poorly conditioned matrix unless a value of *DON* of approximately one half is used. This must of course be accompanied by a sufficiently small value of *AL* to permit small elements to be generated.

*AL* should normally be set equal to the width of the narrowest pillar, stope, or the smallest hangingwall to footwall distance. This will permit the discretization routine to use as small size elements as are necessary to ensure proper matrix conditioning.

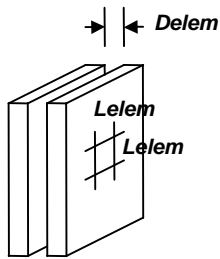

The most difficult type of problem to solve is one where narrow pillars are defined or where narrowly spaced joints are used. As above, *Delem* is the stope or pillar width. The element side length can also be calculated from the *DON* ratio, however, for this type of problem, where excavations are very near one another, creating narrow pillars, a poorly conditioned unsolvable matrix will be created unless a value of *DON* of approximately one is used. This must of course be accompanied by a sufficiently small value of *AL* to permit small elements to be generated.

The recommended value of *DON* is 0.5 for narrow stopes problems and 1 for narrow pillar problems.

*AL* should normally be set equal to the width of the narrowest pillar or the smallest hangingwall to footwall distance. This will permit the discretization routine to use as small size elements as are necessary to ensure proper matrix conditioning.

In summary, *AL* should be set equal to the width of the narrowest pillar or the smallest hangingwall to footwall distance. Larger values may be necessary if too many elements are generated. *DON* should be set to 0.5 for normal problems, and 1.0 for problems where narrow pillars are defined.

During discretization, Map3D will attempt to satisfy the specified *DON* ratio for all elements. When discretizing, the maximum number of boundary elements that any block or plate edge can be divided into is 256. If this number of subdivisions is reached, and the specified *DON* ratio has still not been achieved, Map3D will issue a warning message instructing the user to subdivide the block or plate into smaller pieces.

Once discretization is complete, the distance *Delem* can be plotted using

 [Plot > Miscellaneous > Delem](#) Distance to nearest element on surfaces

The ratio of *Delem/Lelem* can be plotted using

 [Plot > Miscellaneous > Delem/Lelem DON](#) ratio on surfaces

Locations where *DON* is small (less than 0.5) could result in a non-convergent solution process.

Note that if desired, this behaviour can be overridden on an element by element basis by specifying the maximum width for each element

 [CAD > Edit > Entity Properties > Maximum Width](#)

### ***DOL* and *AG* - Solution Accuracy**

During the discretization process Blocks and DD planes are subdivided into boundary elements with side length *Lgrid*. The element size is determined from the minimum distance *Dgrid* to the nearest field point grid plane according to the relation

$$L_{grid} = D_{grid} / DOL$$

Since at some locations the distance *Dgrid* may be zero, a minimum element side length *AG* must also be specified.

This same relationship is also used to subdivide grid planes into points where field stresses, strains and displacements are calculated. A minimum grid spacing of half *AG* will be used.

The *AG* parameter should be set equal to smallest dimension of interest. To obtain reasonable accurate results, *AG* should be set to approximately one quarter the slope or pillar width. For example if the user wants to see the stress distribution across a 2m wide pillar, a value of 0.5 for *AG* would give a sufficient number of field points for accurate contouring.

The same units used to specify the coordinate locations should be used (e.g. metres or feet).

A value for *DOL* of 1.0 is recommended for all problems except those where increased accuracy is required. With a value of 1.0 an error of 10-20% can be expected. A value of 2.0 should provide 5-10% error. A value of 4.0 should provide less than 2% error.

Although higher values for *DOL* result in more elements being generated, this is necessary to obtain increased accuracy.

*DOL* controls the way in which grids and block surfaces are subdivided. This parameter along with *AG*, is used to control the amount of detailed accuracy one requires in the results.

*AG* should be selected to reflect the size of interest. For example, if details of the stress distribution are only required to within one metre of the surface excavations, then *AG* should be set equal to one metre.

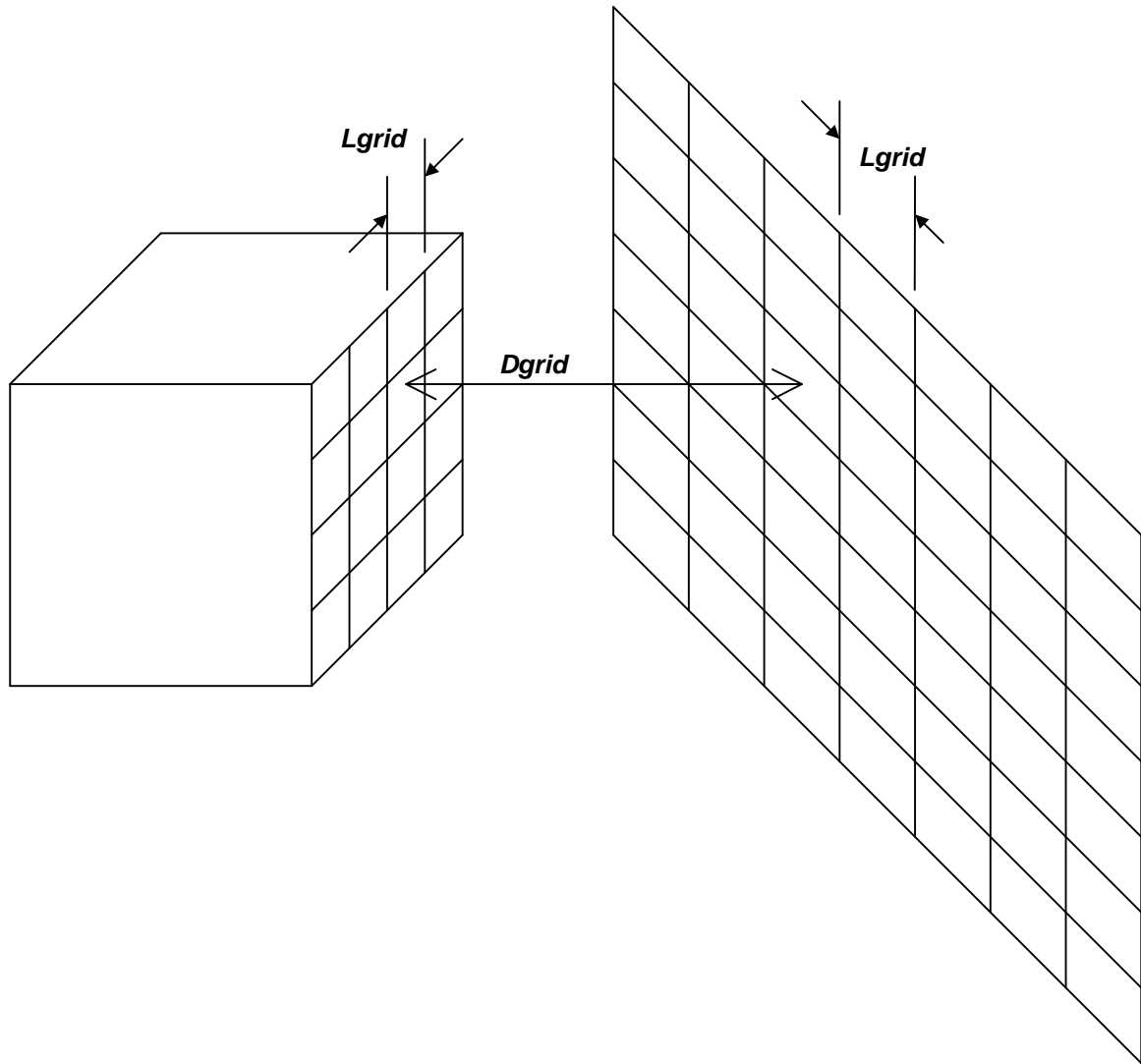

The field point spacing and element side length *Lgrid*, are determined from the specified *DOL* ratio. *Dgrid* is determined as the minimum distance from a given element to the nearest grid. Since *Lgrid* can be calculated from the *DOL* ratio as

$$Lgrid = Dgrid / DOL$$

such that *Lgrid* is not less than *AG*, small values of *DOL* will generate small elements and grid spacing only near locations where grids pass near to stopes. As one moves away from these areas, the element size will very quickly increase.





*DOL = 1*

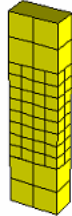

*DOL = 2*

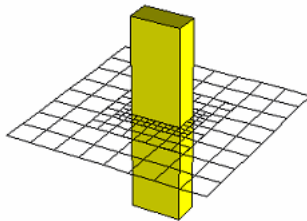

*DOL = 1*

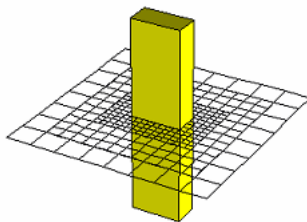

*DOL = 2*

Small values of *DOL* (one or less) will generate small field point spacings and small elements only near locations where the grid intersects or passes very close to the block. As one moves further away from these areas, the field point spacing and element side length will very quickly increase. Larger values of *DOL* (two or more) will increase the distance over which the field point spacing and element side length are kept small.

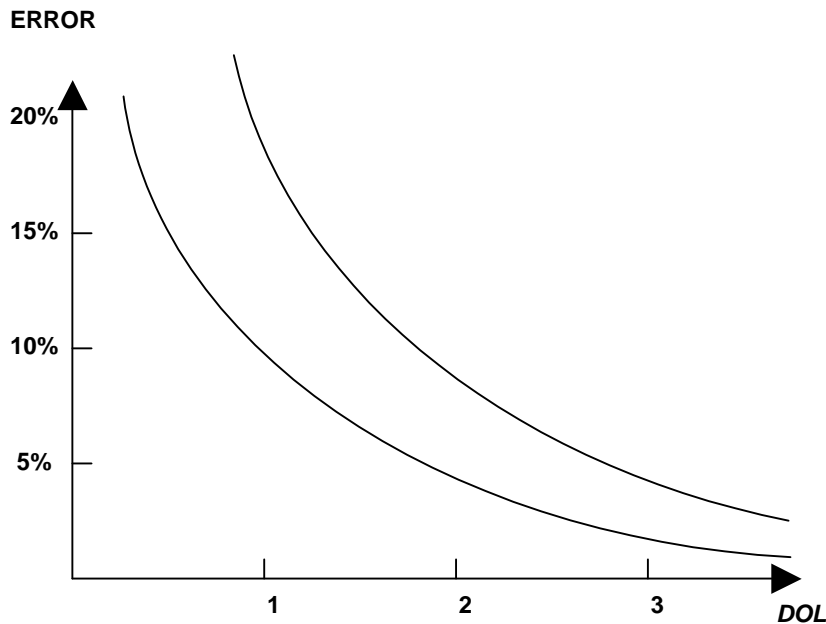

Result accuracy can be directly related to the magnitude of *DOL*. Errors are limited to approximately 10-20% for *DOL* near one, and 5-10% for *DOL* near two. These values are only approximate, and it is therefore recommended that in problems where high accuracy is required, values of *DOL* near four be used. In problems where low accuracy is necessary, *DOL* near one is adequate. It is not recommended to set *DOL* less than one.

Note that large values of *DOL* and small values for *AG* result in increased number of elements and increased run times, but greater accuracy.

In summary, *AG* should be set to the resolution of interest (a fraction of the slope width). *DOL* should be set to 1 for coarse analysis results, 2 for detailed analysis results, and 4 when very high accuracy is required.

During discretization, Map3D will attempt to satisfy the specified *DOL* ratio for all elements and grids. When discretizing, the maximum number of boundary elements that any block or plate edge can be divided into is 256. The maximum number of field points that any grid edge can be divided into is also 256. If this number of subdivisions is reached, and the specified *DOL* ratio has still not been achieved, Map3D will issue a warning message instructing the user to subdivide the block, plate or grid into smaller pieces.

Once discretization is complete, the distance *Dgrid* can be plotted on model surfaces using

 [Plot > Miscellaneous > Dgrid](#) Distance to nearest grid on surfaces

or on grids using

 [Plot > Miscellaneous > Dgrid](#) Distance to nearest element on grids

The ratio of *Dgrid/Lgrid* can be plotted on model surfaces using

 [Plot > Miscellaneous > Dgrid/Lgrid](#) *DOL* ratio on surfaces

or on grids using

 [Plot > Miscellaneous > Dgrid/Lgrid DOL](#) ratio on grids

Note that if desired, this behaviour can be overridden on a grid by grid basis by specifying the maximum width for each grid

 [CAD > Edit > Entity Properties > Maximum Width](#)

### **DOR - Element Aspect Ratio**

*DOR* controls the maximum element aspect ratio. If the ratio of the side length of an element is determined to exceed *DOR*, that element is subdivided. The recommended value of *DOR* is 5. If erratic results are detected, *DOR* should be decreased to 2. Note that smaller values of *DOR* results in more elements and longer run times, but greater accuracy.

During discretization, Map3D will attempt to satisfy the specified *DOR* ratio for all elements. When discretizing, the maximum number of boundary elements that any block or plate edge can be divided into is 256. If this number of subdivisions is reached, and the specified *DOR* ratio has still not been achieved, Map3D will issue a warning message instructing the user to subdivide the block or plate into smaller pieces.

### **DOC - Matrix Lumping**

During matrix assembly, the distance *Delem* between groups of Blocks and DD planes is examined to see if these can be lumped together for calculation and storage purposes. The amount of lumping depends on how many elements can fit into a zone with side length *Lelem*, determined from the relation

$$Lelem = Delem/DOC$$

A value for *DOC* of 1.0 is recommended for all problems except those where increased accuracy is required. With a value of 1.0 an error of 10-20% can be expected. A value of 2.0 should provide 5-10% error. A value of 4.0 should provide less than 5% error.

Although higher values of *DOC* result in larger problem sizes, this is necessary to obtain increased accuracy.

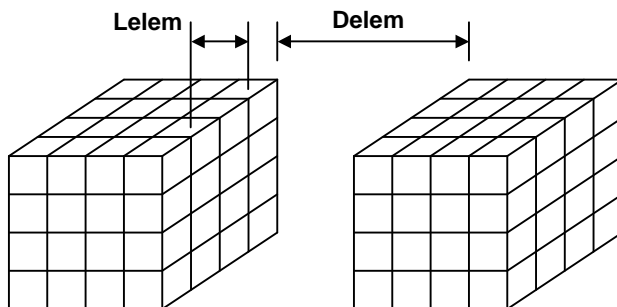

*DOC* controls the way in which elements are lumped during matrix assembly. Elements with combined side length *Lelem*, are lumped if the distance *Delem*, to the affected element exceeds the required *DOC* ratio. If the stope to stope distances are large, many elements can be lumped.

Small values of *DOC* (one or less) will provide maximum lumping, however, stresses near excavation surfaces will deteriorate in accuracy, and matrix conditioning will be reduced. Larger values of *DOC* (two or more) will provide less lumping, but accuracy and good matrix conditioning will be maintained.

*DOC* should be set to 1 for coarse analysis results, 2 for detailed analysis results, and 4 when very

high accuracy is required. Note that large values of *DOC* results in increased matrix size and longer run times, but greater accuracy.

### **DOE - Element Lumping**

During the calculation of field points (i.e. grid assembly), the distance *Dgrid* between these points and groups of Blocks and DD planes is examined to see if these groups can be lumped together for calculation purposes. The amount of lumping depends on how many elements can fit into a zone with side length *Lgrid*, determined from the relation

$$Lgrid = Dgrid/DOE$$

A value for *DOE* of 2.0 is recommended for all problems except those where increased accuracy is required. With a value of 2.0 an error of 10-20% can be expected. A value of 4.0 should provide 5-10% error. A value of 8.0 should provide less than 5% error.

Although higher values of *DOE* result in larger analysis times, this is necessary to obtain increased accuracy.

*DOE* controls the way in which elements are lumped during field point calculations. Elements with combined side length *Lgrid*, are lumped if the distance *Dgrid*, to the field point exceeds the required *DOE* ratio. Small values of *DOE* (two or less) will provide maximum lumping, however, stresses distributions near excavation surfaces will deteriorate in accuracy and become erratic. Larger values of *DOE* (four or more) will provide less lumping, but accuracy and smooth stress distributions will be ensured.

*DOE* should be set to 2 for coarse analysis results, 4 for detailed analysis results, and 8 when very high accuracy is required. Note that large values of *DOE* results in increased matrix size and longer run times, but greater accuracy.

### **DOG - Grid Lumping**

During the calculation of field points (i.e. grid assembly), the distance *Dgrid* between these points and groups of Blocks and DD planes is examined to see if these field points can be lumped together for calculation purposes. The amount of lumping depends on how many field points can fit into a zone with side length *Lgrid*, determined from the relation

$$Lgrid = Dgrid/DOG$$

A value for *DOG* of 2.0 is recommended for all problems except those where increased accuracy is required. With a value of 2.0 an error of 10-20% can be expected. A value of 4.0 should provide 5-10% error. A value of 8.0 should provide less than 5% error.

Although higher values of *DOG* result in larger analysis times, this is necessary to obtain increased accuracy.

*DOG* controls the way in which field points are lumped during field point calculations. Field points with combined spacing length *Lgrid*, are lumped if the distance *DOG*, to the affecting element exceeds the required *DOG* ratio. Small values of *DOG* (two or less) will provide maximum lumping, however, stresses distributions near excavation surfaces will deteriorate in accuracy and become erratic. Larger values of *DOG* (four or more) will provide less lumping, but accuracy and smooth stress distributions will be ensured.

*DOG* should be set to 2 for coarse analysis results, 4 for detailed analysis results, and 8 when very high accuracy is required. Note that large values of *DOG* results in increased matrix size and longer run times, but greater accuracy.

**Map3D  
User's Manual**

**Part**



## 3 Model Building Tutorials

### 3.1 Freehand Sketching - Room and Pillar Mining

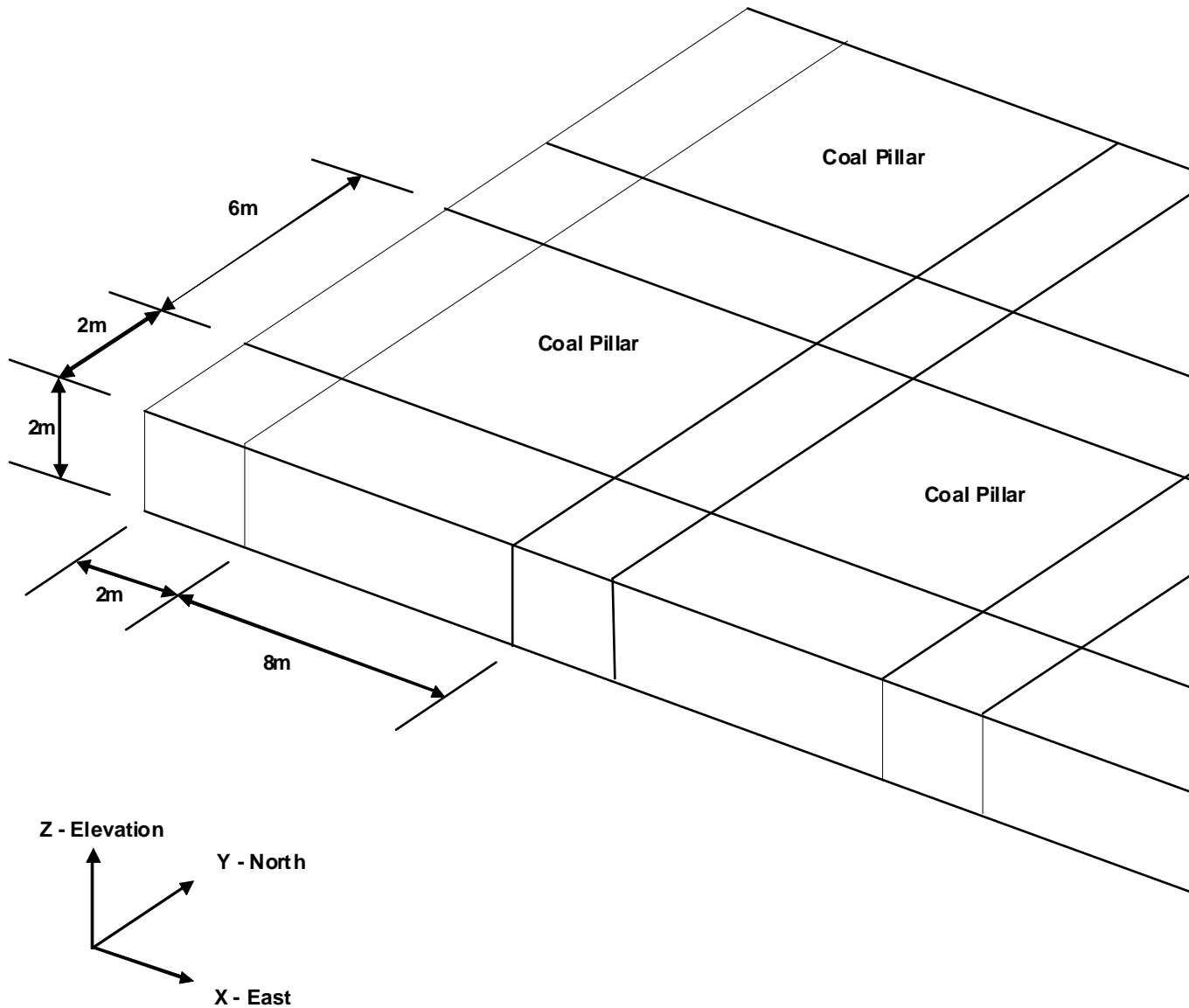

To demonstrate the freehand sketching technique, let's start by building a simple room and pillar coal mining geometry. The roadways measure 2m wide by 2m high, and the coal pillars measure 6m towards the East and 4m towards the West.

We want to start with a clean slate, so we will select

[File > New Model](#)

Before beginning please note that the user can hover over any button to obtain a tooltip identifying that buttons function. Also the use can right click on any item to obtain detailed help on that function.

**Building the Intersection**

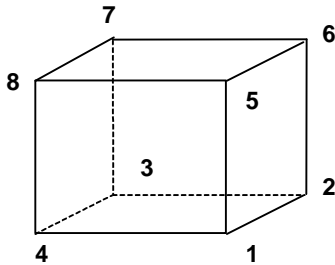

First let's construct an intersection. This will be constructed using blocks with 8 corners. To construct the first block, use [CAD > Build > FFLoop](#). This function can be selected from the CAD toolbar as follows (activate the CAD toolbar if it is not visible using [Tools > CAD Toolbar](#)):



Select  [CAD > Build](#) from the CAD toolbar

You will be presented with the sub-menu of build functions



Now select

 [CAD > Build > FFLoop](#)

Since we are going to be freehand drawing we must set up the snap grid. This is done using [CAD > Snap > Rectangular Grid Snap](#). This function can be selected from the Build Entity toolbar

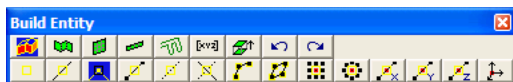

To activate the snap grid select

 [CAD > Snap > Rectangular Grid Snap](#)

(this only needs to be done if the grid snap button is not already highlighted ).

The coordinates of the current cursor location are indicated on the status bar. You will notice that the x and y values change as you move the cursor about, but not the z value. To set the current z value, click on  [CAD > Snap > Cursor/Grid Setup](#), you will be prompted as follows:

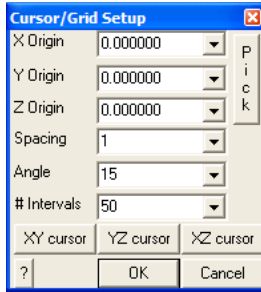

Set the origin and snap spacing as follows:

X-Origin > 0  
 Y-Origin > 0  
 Z-Origin > 0  
 Snap spacing > 1

If the cursor cross-hairs are not moving the x-y plane, select the  XY cursor button.

This sets the snap mode to grid. In this mode, no pick-box will be displayed at the intersection of the cross-hairs and the movement of the cursor will be restricted to the specified grid spacing. As you move the cursor around the display the cursor will jump from location to location by the grid spacing amount (1 metre in this case).

You will see that the [FFLoop](#) building routine is prompting you to enter the first corner of the block on the status bar

**Input: Select Point 1**

Move the cursor about until you locate the first point

x,y,z > 0 0 0

Select this point by clicking the left mouse button once.

You will now be prompted for the next block corner

**Input: Select Point 2**

As you move the cursor about you will see that not only is the current cursor location indicated at the lower left hand corner of the display, but also the offset of the current point from the last one selected (i.e. the offset vector from point 1 to point 2). Select point 2 at

x,y,z > 2 0 0

Repeat this selection process for point 3

x,y,z > 2 2 0

and point 4

x,y,z > 0 2 0

If you select the wrong location for a point, simply undo that selection using the undo button

 [CAD > Build > Undo Point](#) then try again.

Finally, reselect the first point



x,y,z > 0 0 0

When first point has been reselected, the base of the block has been completely formed. You will be prompted with the message

**Loop complete: Start next loop.**

To complete building the block you can either change the elevation and select the remaining 4 points (i.e. points 5, 6, 7 and 8), or generate them from the first 4 corners by adding an offset to them. To use this latter procedure, select the offset function from the build entity toolbar

 [CAD > Build > Extrude/Offset Remaining](#)

You will be prompted for this offset vector as follows

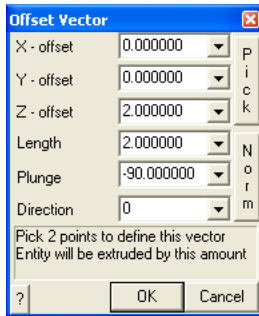

Enter the offset as:

X-offset > 0

Y-offset > 0

Z-offset > 2

Points 5, 6, 7 and 8 will be generated respectively from points 1, 2, 3 and 4 by adding the offset values to their coordinates.

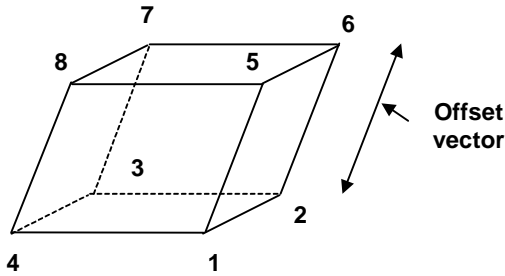

Upon completion of block construction you will automatically be prompted to enter the block properties ( [CAD > Build > FFLoop](#))



Enter the following:

Block Name: [Intersection](#)  
 Element Type: [Fictitious Force](#)  
 Block Colour: [1](#)

This intersection block should be excavated at mining step 1. This is indicated by specifying

Mining Step 1: [0](#)

We are now finished and can Build this block by pressing the [Build](#) button.

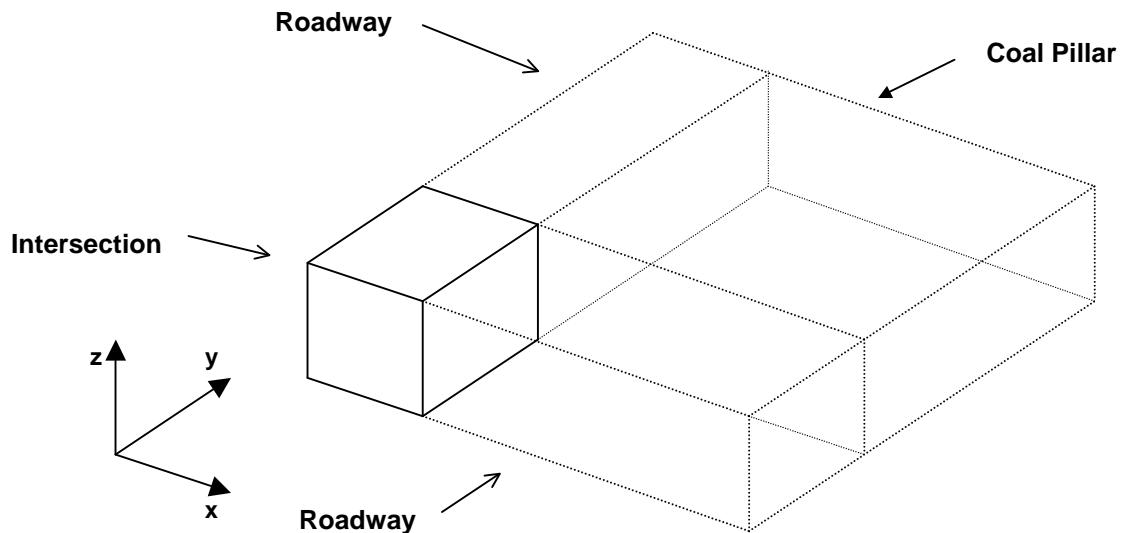

### Repositioning The View

During block building or at any other time, the user is free to reposition (translate, rotate or zoom) the geometry to make visualization easier. This is readily accomplished by several means (refer to [Rotating the Model](#) and [Translating the Model](#)).

### Building the Roadway 1

Additional blocks can now be constructed by selecting the **FFLoop** building function again

 [CAD > Build > FFLoop](#)

Let's build the next block adjacent to the first one. Select point 1 at

$x,y,z > 2\ 0\ 0$

We would like to select point 2 at

$x,y,z > 8\ 0\ 0$

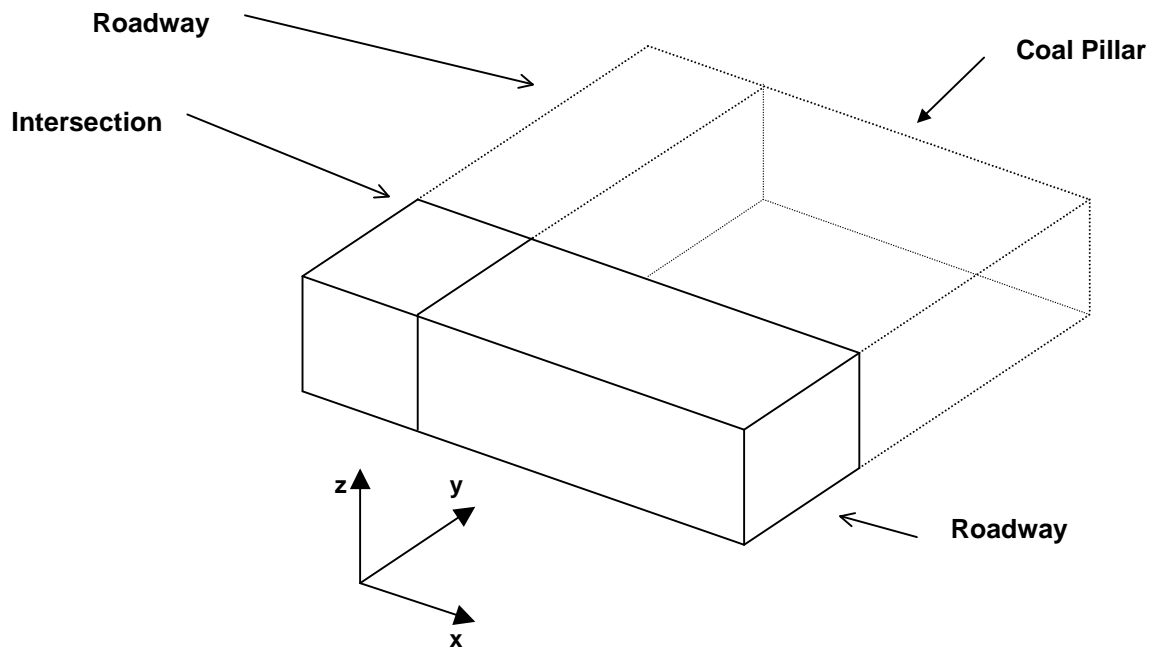

but this location is beyond the limits of the display. To overcome this problem, simply zoom out ([Translating the Model](#)).

Point 2 can now be readily selected.

Select point 3 at

$x,y,z > 8\ 2\ 0$

Select point 4 at

$x,y,z > 2\ 2\ 0$

Finally, reselect the first point

$x,y,z > 2\ 0\ 0$

When first point has been reselected, the base of the block has been completely formed. You will be prompted as before with the message

**Loop complete: Start next loop.**

Now offset the remaining points for this block using the offset function

 [CAD > Build > Extrude/Offset Remaining](#)

You will be prompted for this offset vector as follows

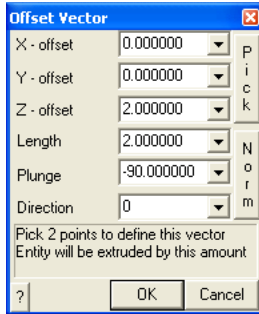

Enter the offset as:

X-offset > 0  
 Y-offset > 0  
 Z-offset > 2

Upon completion of block construction you will automatically be prompted to enter the entity properties ( [CAD > Build > FFLoop](#))

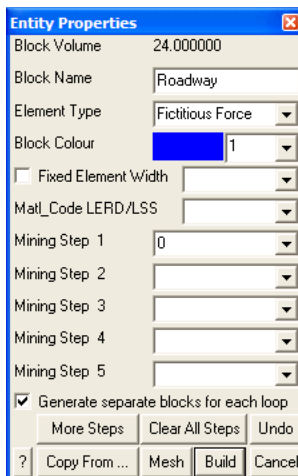

Enter the following:

Block Name: [Roadway](#)  
 Element Type: [Fictitious Force](#)  
 Block Colour: 1

This roadway block should be excavated at mining step 1. This is indicated by specifying

Mining Step 1: 0

We are now finished and can build this block by pressing the  button.

## Building the Roadway 2

Let's construct a third block

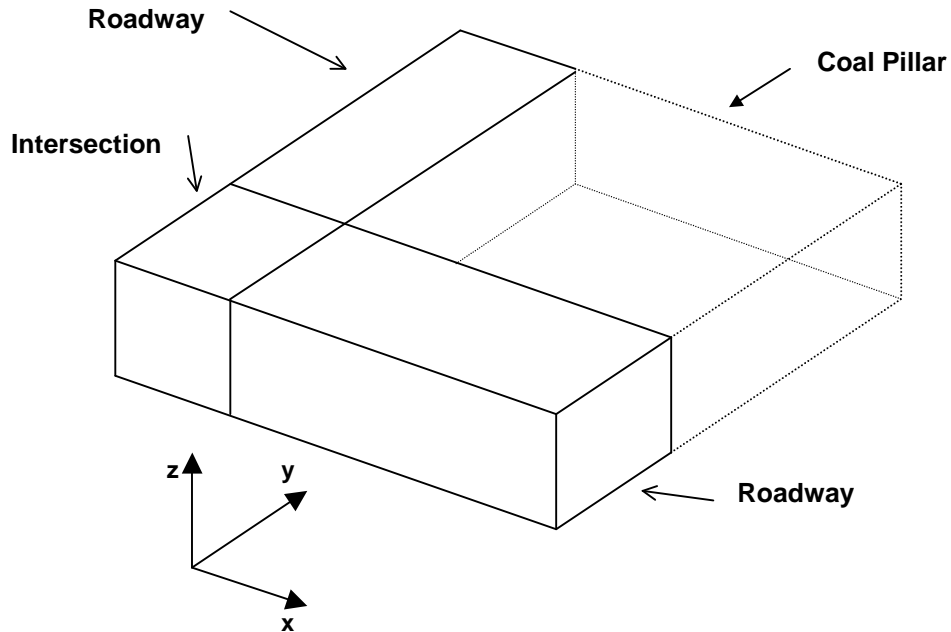

by selecting point 1 at

$x,y,z > 2\ 2\ 0$

Select point 2 at

$x,y,z > 2\ 6\ 0$

Select point 3 at

$x,y,z > 0\ 6\ 0$

Select point 4 at

$x,y,z > 0\ 2\ 0$

Reselect the first point to complete construction of the base

$x,y,z > 2\ 0\ 0$

then offset the remaining points as before

 [CAD > Build > Extrude/Offset Remaining](#)

This will complete construction of the roadway.

### Building the Coal Pillar

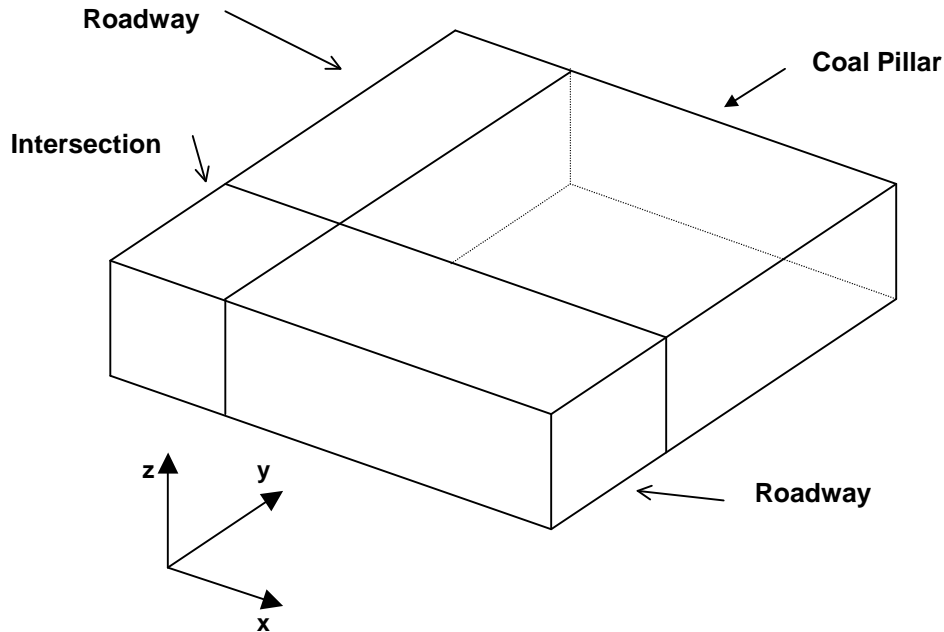

You should now have completed construction of an intersection and two roadways. Now let's construct a coal pillar.

 [CAD > Build > FFLoop](#)

by selecting point 1 at

$x,y,z > 2\ 2\ 0$

Select point 2 at

$x,y,z > 8\ 2\ 0$

Select point 3 at

$x,y,z > 8\ 6\ 0$

Select point 4 at

$x,y,z > 2\ 6\ 0$

Reselect the first point to complete construction of the base

$x,y,z > 2\ 2\ 0$

then offset the remaining points as before

 [CAD > Build > Extrude/Offset Remaining](#)

This will complete construction of the coal pillar.

Upon completion of block construction you will automatically be prompted to enter the block properties ( [CAD > Build > FFLoop](#)). We must specify that this block will be a coal pillar rather than an excavation (the default). You will be prompted as follows:

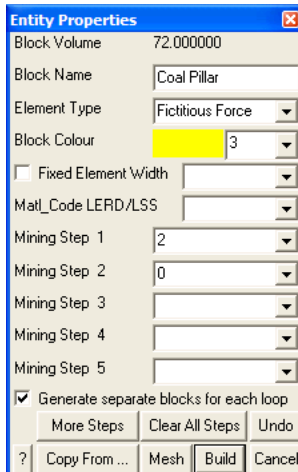

Enter the following:

Block Name: [Coal Pillar](#)  
 Element Type: [Fictitious Force](#)  
 Block Colour: [3](#)

We must specify that this block has the material properties for coal. This is done by defining material number 2 for coal at mining step 1. This is indicated by specifying

Mining Step 1: [2](#)

This same pillar could be excavated at step 2 by specifying a material code of

Mining Step 2: [0](#)

We are now finished and can Build this block.

### Saving the Geometry

At this point we have constructed one small corner of the desired mining geometry. Before proceeding further it would be a good idea to save the model as built so far. To do this we select

[File > Save Model As](#)

Let's save with the name "COAL.INP"

### Expanding the Geometry

The model as constructed represents only a small part of the final model. It is easy to repeat this pattern by copying this pattern multiple times. To do this we must select the copy function

[CAD > Edit > Copy Entities](#)

This function can also be selected from the CAD toolbar as follows:

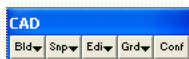

Select [CAD > Edit](#) from the CAD toolbar

You will be presented with the sub-menu of edit functions



To activate the copy function select

 [CAD > Edit > Copy Entities](#)

At this point you will be prompted to build a list of entities to copy



Hold down the Shift-key and drag out a selection window (alternatively you may select the crossing window function ).

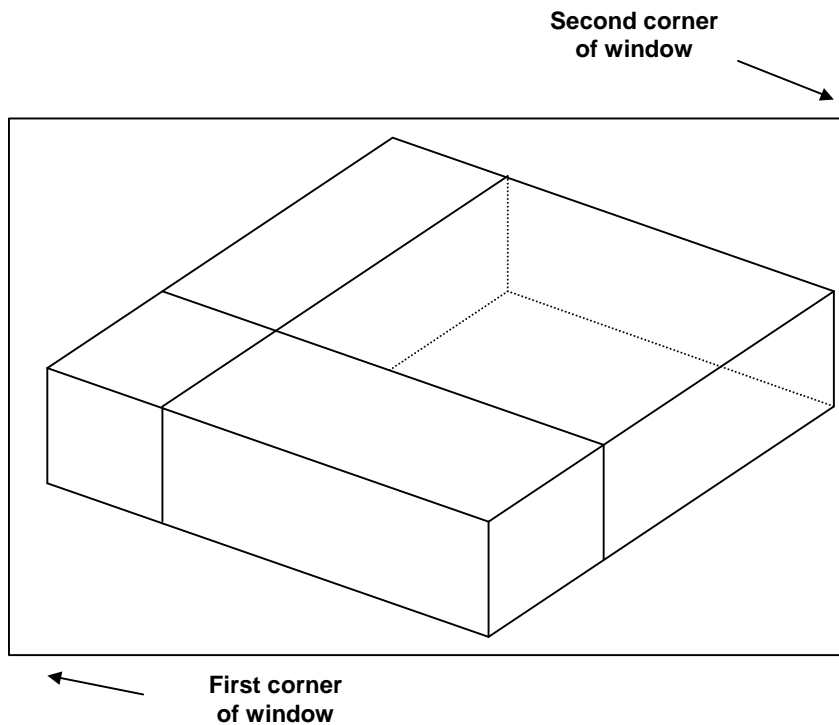

All entities within the selection window (i.e. the intersection, roadways and coal pillar) should be highlighted.

You can now copy the selected entities by picking the copy button .

You will be prompted to enter the copy-offset vector as follows:



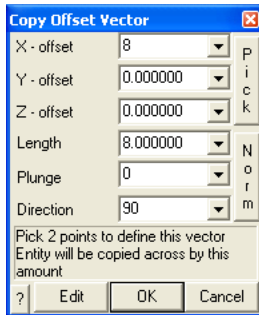

There are numerous ways to select the copy-offset vector. You can type in the desired offset as (8 0 0).

This is also readily accomplished graphically by picking two points to define the vector. First set the snap mode to

 [CAD > Snap > Rectangular Grid Snap](#)

(this only needs to be done if the grid snap button is not already highlighted .

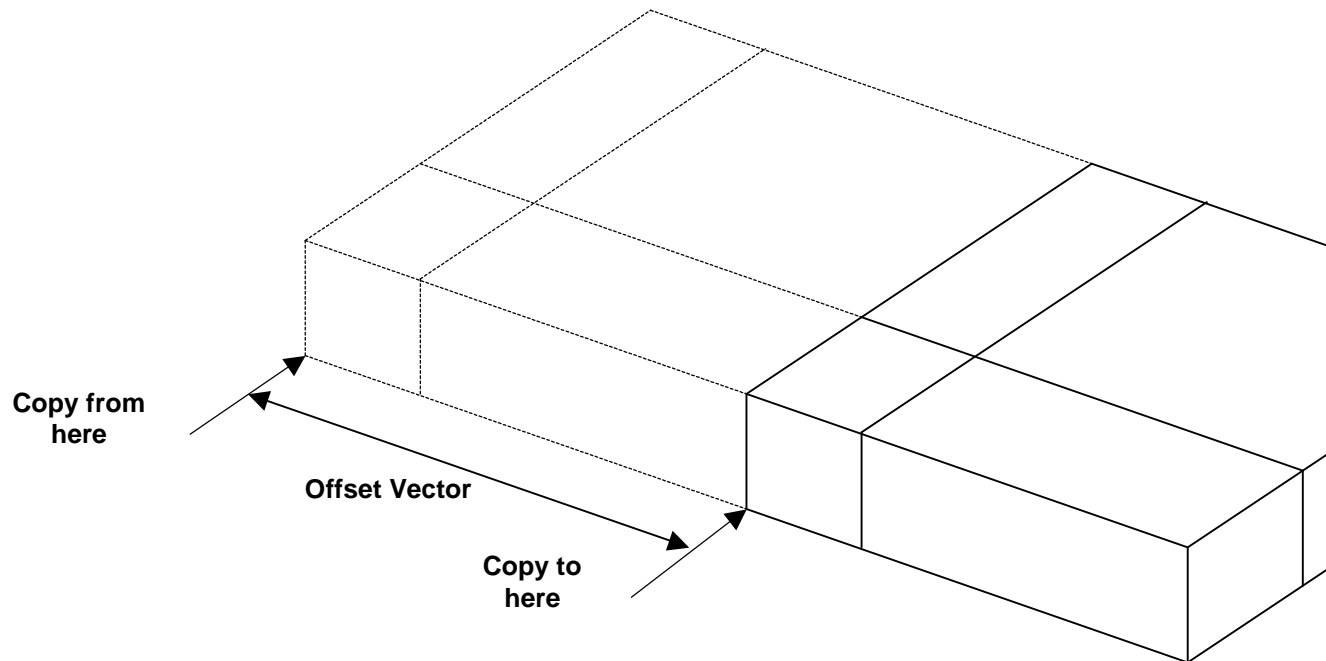

You will be prompted (at the top of the screen) to pick the first end of the offset vector

**INPUT: Select first offset point**

Select this point at

x,y,z > 0 0 0

You will then be prompted to pick the other end of the offset vector

**INPUT: Select second offset point**

Select this point at

x,y,z > 8 0 0

The offset (8 0 0) will now be displayed in the dialog box.

Now press OK, and the selected entities will be copied by adding the offset vector to all coordinates.

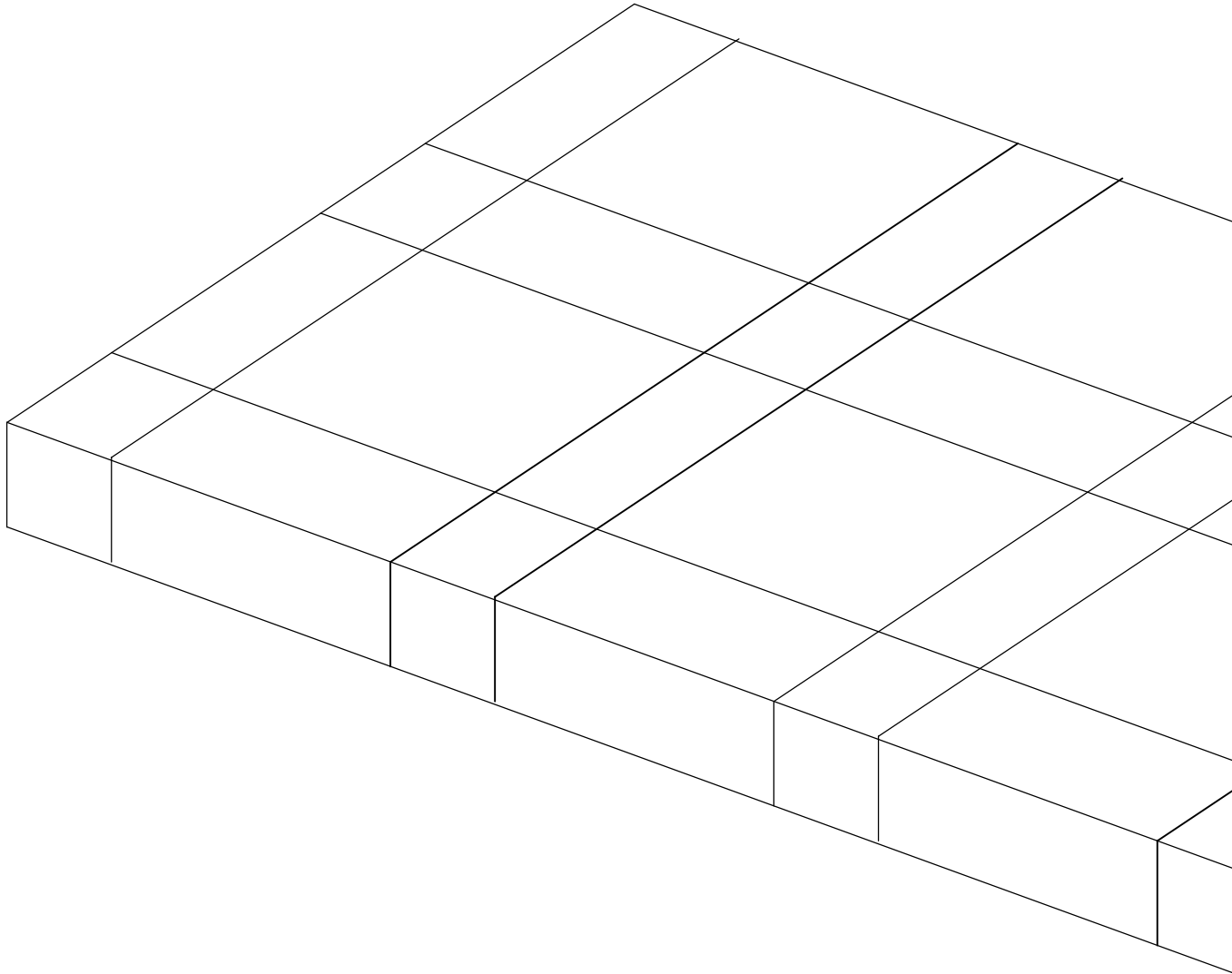

To repeat this copy operation, either rebuild the selection set, or select  to restore the previous selection set, then copy the selected entities by picking the copy function again

 [CAD > Edit > Copy Entities](#)

If desired, this copy procedure can be repeated as many times as desired to duplicate the mining pattern in the x and y directions.

At this point the geometry can be considered complete. We must now define the location of grid planes where results will be calculated and specify the material properties.

### Building Grid Planes

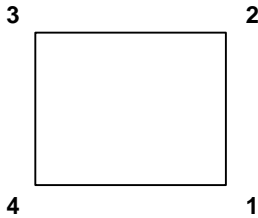

We must now decide where we want results to be calculated. In this example we are interested in the stress in the coal pillars. We will therefore define a cross-sectional grid plane that passes through the centre of one of the pillars. This will be constructed using a plane with 4 corners. To construct this plane, select the grid building menu function

[CAD > Build > Grid Plane](#)

This function can also be selected from the CAD toolbar as follows:



Select [CAD > Build](#) from the CAD toolbar

You will be presented with the sub-menu of build functions



Now select

 [CAD > Build > Grid Plane](#)

Since we are going to be freehand drawing we must set up the snap grid. This is done using CAD > Snap > Rectangular Grid Snap. This function can be selected from the Build Entity toolbar

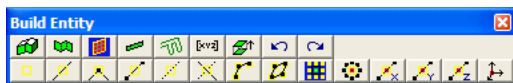

To activate the snap grid select

 [CAD > Snap > Rectangular Grid Snap](#)

(this only needs to be done if the grid snap button is not already highlighted ).

The coordinates of the current cursor location are indicated on the status bar. To set the current z value, click on  [CAD > Snap > Cursor/Grid Setup](#), you will be prompted as follows:

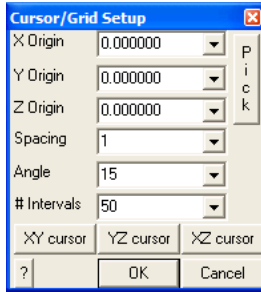

Set the origin and snap spacing as follows:

X-Origin > 0  
 Y-Origin > 0  
 Z-Origin > -2  
 Snap spacing > 1

If the cursor cross-hairs are not moving the x-y plane, select the  button.

You will see that the grid plane building routine is prompting you to enter the first corner of the plane

**INPUT: Select point 1**

Move the cursor about until you locate the desired point

x,y,z > 9 4 -2

Select this point by clicking the left mouse button once.

You will now be prompted for the next block corner

**INPUT: Select point 2**

Select point 2 at

x,y,z > 17 4 -2

If you select the wrong location for a point, simply undo that selection

 [CAD > Build > Undo Point](#)

then try again.

When point 2 has been selected, one edge of the plane has been completely formed. To complete building the plane you can either change the elevation and select the remaining 2 points (i.e. points 3 and 4), or generate them from the first 2 corners by adding an offset to them. To use this latter procedure, select the offset function from the build entity toolbar

 [CAD > Build > Offset Remaining](#)

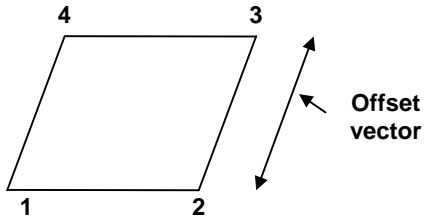

You will be prompted for this offset vector as follows

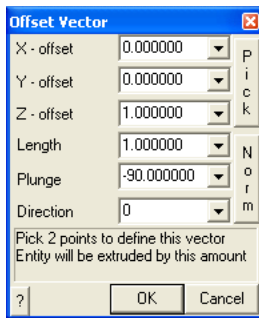

Enter the offset as:

X-offset > 0

Y-offset > 0

Z-offset > 6

Points 3 and 4 will be generated respectively from points 2 and 1 by adding the offset values to their coordinates.

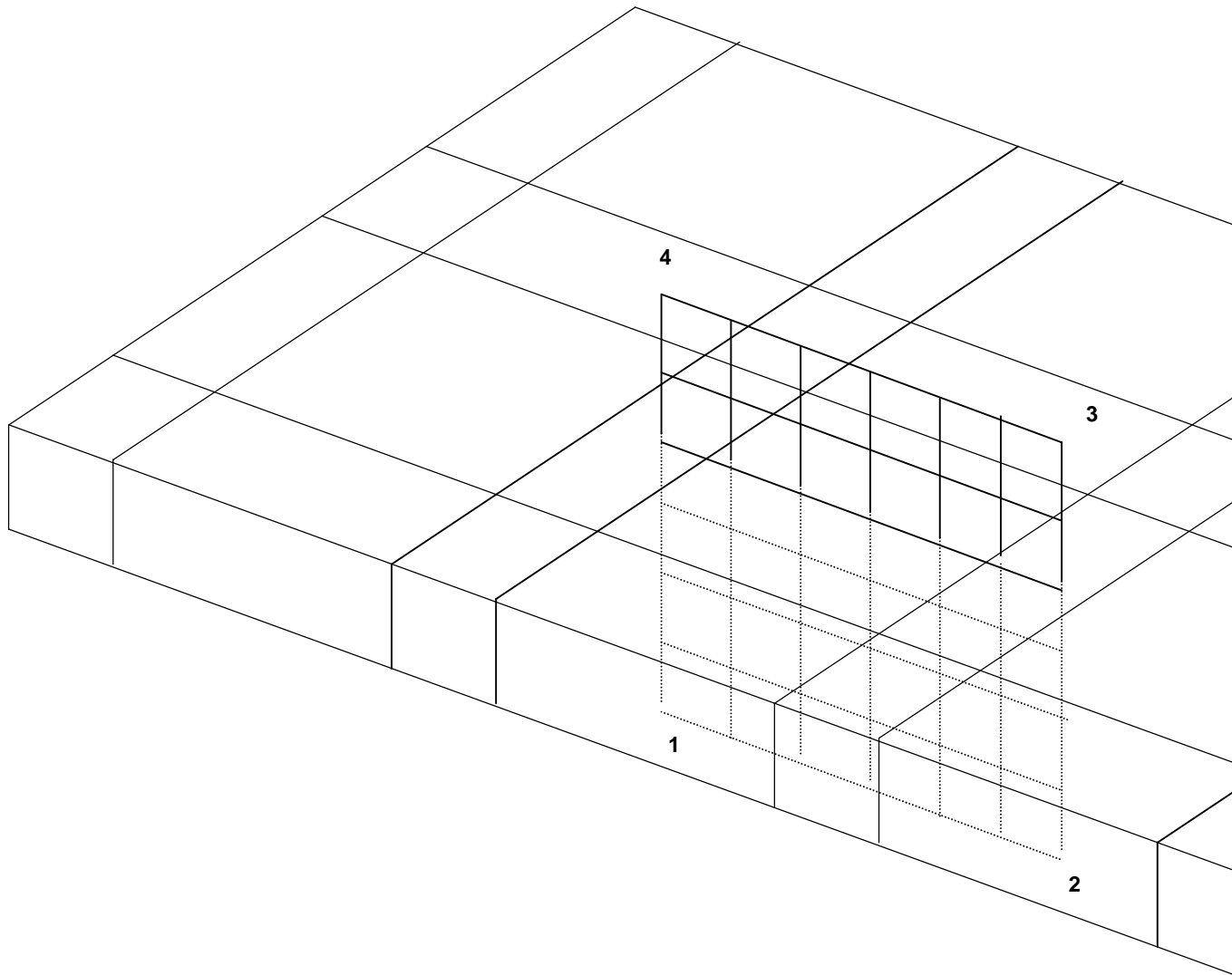

This will complete construction of the grid plane ([CAD > Build > Grid Plane](#))

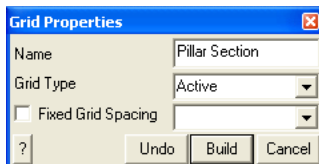

Enter a descriptive name for the grid plane and leave the [Fixed Grid Spacing](#) check box unchecked.

### Specifying Material Properties for the Sandstone Host

We must now specify properties for the host material. These are entered using the material properties function

[CAD > Properties > Material Properties.](#)

Selecting this item opens a sub-menu of items associated with editing the material properties. Note that material number 1 is by definition the host material. Other material numbers are used to define alternate material zones such as the coal, fault gouge, backfill etc. The user is first prompted to enter the material number that is to be edited. First let's define properties for the host material

	Peak	Residual
Tension Cutoff	0	0
UCS	60	60
Cohesion	0	0
Friction Angle	30	30
Dilation Angle	0	
Young's Modulus	11000	11000
Poisson's Ratio	0.160	0.160
Viscous Mod (Gn)	0	
Viscous Mod (Gs)	0	
Expansion Coef	1	
Conductivity	1	

Enter the following:

Material Name: [Sandstone Host](#)

Material # : [1](#)

Young's Modulus: [11000 MPa](#)

Poisson's Ratio: [0.16](#)

The Viscous Moduli can be set to zero since they are only used to simulate creep response in non-linear analysis.

We want to use the Mohr-Coulomb criterion here. To do this set

Material Type: [Mohr-Coulomb](#)

UCS: [60 MPa](#)

The cohesion parameter is not used in this case and hence can be set to zero.

Friction Angle: [30°](#)

The dilation angle is not used in this case and hence can be set to zero.

The pre-mining stress state can now be specified

[Stress State](#) [CAD > Properties > Material Properties > Stress State](#)

Pre-mining Stress State	
Datum	0
$\sigma_a$ constant	5
$\sigma_b$ constant	5
$\sigma_c$ constant	10
$\Delta\sigma_a$ variation	0
$\Delta\sigma_b$ variation	0
$\Delta\sigma_c$ variation	0
$\sigma_a$ trend	0
$\sigma_a$ plunge	0
$\sigma_c$ trend	0
t/h constant	0
$\Delta t/h$ variation	0
? Copy from... Cartesian Close	

The appropriate far field stress state for this model is

$\sigma_a$  constant: 5 MPa  
 $\sigma_b$  constant: 5 MPa  
 $\sigma_c$  constant: 10 MPa

We will set the variation of stress with depth to zero

$\Delta\sigma_a$  variation: 0 MPa/m  
 $\Delta\sigma_b$  variation: 0 MPa/m  
 $\Delta\sigma_c$  variation: 0 MPa/m

Also the stress orientations (trend and plunge) should be set to zero, thus defining  $\sigma_a$  and  $\sigma_b$  as horizontal and  $\sigma_c$  as vertical.

The Datum can also be set to zero since this is only used to define the variation with depth.

### Specifying Material Properties for the Coal Seam

We must now specify properties for the coal seam. These are entered using the material properties function

[CAD > Properties > Material Properties](#)

Selecting this item opens a sub-menu of items associated with editing the material properties. Recall that when building the coal pillar, we specified that material number 2 was to be used for that block.

Let's set Material # to 2.



The Material Properties dialog box for 'Coal Seam' shows the following settings:

	Peak	Residual
Tension Cutoff	0	0
UCS	7.2	7.2
Cohesion	0	0
Friction Angle	27	27
Dilation Angle	0	
Young's Modulus	3500	3500
Poisson's Ratio	0.250	0.250
Viscous Mod (Gn)	0	
Viscous Mod (Gs)	0	
Expansion Coef	1	
Conductivity	1	

Material Name: Coal Seam  
 Material #: 2  
 Material Type: Mohr-Coulomb  
 Behavior: Elastic only (selected)  
 Buttons: Copy from matl..., Stress State, Close

Enter the following:

Material Name: [Coal Seam](#)  
 Young's Modulus: [3500 MPa](#)  
 Poisson's Ratio: [0.25](#)

The Viscous Moduli can be set to zero since they are only used to simulate creep response in non-linear analysis.

We want to use the Mohr-Coulomb criterion here. To do this set

Material Type: [Mohr-Coulomb](#)  
 UCS: [7.2 MPa](#)

The cohesion parameter is not used in this case and hence can be set to zero.

Friction Angle: [27°](#)

The dilation angle is not used in this case and hence can be set to zero.

The pre-mining stress state can now be specified

Stress State [CAD > Properties > Material Properties > Stress State](#)

The Pre-mining Stress State dialog box shows the following settings:

Datum	0
$\sigma_3$ constant	5
$\sigma_b$ constant	5
$\sigma_c$ constant	10
$\Delta\sigma_3$ variation	0
$\Delta\sigma_b$ variation	0
$\Delta\sigma_c$ variation	0
$\sigma_3$ trend	0
$\sigma_3$ plunge	0
$\sigma_c$ trend	0
t/h constant	0
$\Delta t/h$ variation	0

Buttons: Copy from..., Cartesian, Close

We want the initial stress in the coal to be the same as in the sandstone host, so lets Copy from material 1.

## Specifying Control Parameters

We must now specify parameters to control model discretization and solution. These are entered using the control parameters function

[CAD > Properties > Control Parameters](#)

Selecting this item opens a dialog box of items associated with the control parameters

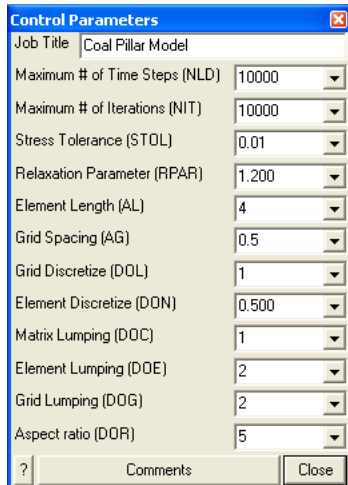

Enter the following:

Job Title: [Coal Pillar Model](#)

All parameters can be left at there default values except the stress tolerance, element length and grid spacing.

Stress Tolerance: [0.01 MPa](#)

should be set to approximately 0.1% of the far field stress state. This ensures that during solution, the surface stresses will be calculated with 0.01 MPa numerical accuracy.

Element Length: [4](#)

should be set equal to twice the thickness of the coal seam This parameter is used to control the minimum boundary element size that will be used at locations where narrow seams or pillars are located. This ensures that a well-conditioned, readily solvable problem will be formulated.

Grid Spacing: [0.5](#)

should be set to approximately one quarter of the seam thickness. This parameter is used to control the minimum boundary element size and the minimum spacing on the grid plane that will be used at locations where it passes close to or intersects the model. Accurate results can be obtained as close as half this spacing from the model surfaces. This parameter also ensures that a sufficient number of stress points will be calculated within in the pillar to generate smooth contours.

The user is free to select a larger value for the grid spacing. This will result in smaller problem size and hence shorter run times. However, with larger boundary elements results will be less accurate, especially near the model surfaces, also with wider grid spacing, smooth contours cannot be generated.

Suggested values for the discretization and lumping parameters are as follows:

[DON=0.5, DOL=DOC=1, DOE=DOG=2 for 10-20% error](#)  
[DON=0.5, DOL=DOC=2, DOE=DOG=4 for 5-10% error](#)  
[DON=1.0, DOL=DOC=4, DOE=DOG=8 for < 5% error](#)

Coarse analysis results are recommended for all problems except those where increased accuracy is required. At this setting numerical errors of 10-20% in stress predictions can be expected. The settings for detailed analysis results provide 5-10% numerical error. The settings for high accuracy results provide less than 5% numerical error. The user is free to specify higher accuracy settings for these parameters, however this will result in larger problem size and hence longer run times.

### Running a Map3D Analysis

At this point we have completed construction of the model and are ready to begin an analysis. If you are using Map3D Fault-Slip you will obtain an elastic solution to this problem. If you are using Map3D Non-Linear, a complete non-linear analysis will be conducted.

[Analysis](#) is executed from the main menu.

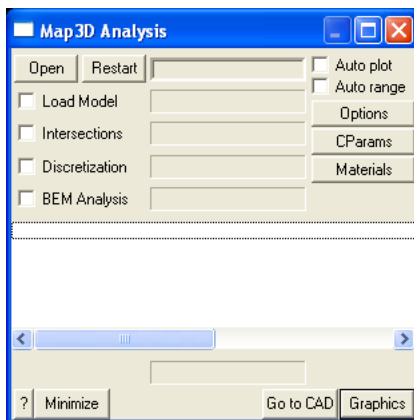

You can run through the complete analysis by selecting

[BEM Analysis](#)

Here we will do this in stages. So first select

[Discretization](#)

If you have modified the model in any way since the last time you saved, you will be prompted to save these modifications.

When the [Intersections](#) and [Discretization](#) analyses are complete select

[Analysis > Graphics](#)

When in graphical mode, you should select the discretized view option

[View > Render > Discretize](#)

This will enable you to see how the block surfaces have been discretized into boundary elements. You must have set outlines on in order to see the individual elements

[View > Render > Block Outlines](#)

To see how the grid has been discretized (activate the Contour toolbar if it is not visible using [Tools > CAD Toolbar](#)), you must select

 [Plot > Grid Selection > Grid #1](#)

from the contour toolbar

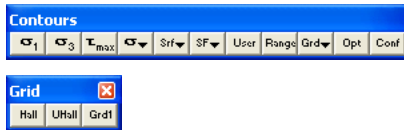

The discretization analysis can be repeated as many times as desired with different values specified for grid spacing, discretization and lumping parameters until the desired density of boundary elements and grids points is achieved.

Once you are satisfied, you can proceed to the BEM Analysis (matrix assembly and solution), by selecting

[Analysis](#)

from the main menu, then selecting

[BEM Analysis](#)

When the analysis is complete, select

[Analysis > Graphics](#)

When in graphical mode, you can contour any desired parameter. For example to display the major principal stress contours, select

 [Plot > Stress > S1](#) Major Principal Stress

This will generate a contour plot on the grid plane.

Interpretation of the results will not be discussed here.

## 3.2 Bulk Mining Example

To demonstrate model building using digitized mine plans, let's build a simple VRM bulk mining geometry.

Construction lines are used to define detailed locations of underground features such as excavations, contacts structure etc. A Map3D model is normally built on top of this construction line data.

The mine plans have been previously digitized using Map3D

[CAD > Digitizer Setup](#)

or some other CAD program. These plans can be saved in either:

[Point file format](#) is a universal ASCII data file with the extension ".PNT". This format is useful for exchanging raw construction line data with other CAD software.

[AutoCAD-DXF](#) format is a popular drawing exchange file with the extension ".DXF". This format is useful for exchanging construction line data with other CAD software.

We want to start with a clean slate, so we will select

[File > New \(Model\)](#)

Before beginning please note that the user can hover over any button to obtain a tooltip identifying that buttons function. Also the use can right click on any item to obtain detailed help on that function.

### Importing digitized mine plans

First we must open a file containing the digitized mine plans. This is done using

[File > Open \(Construction Lines\)](#)

In this case the construction lines have been saved in DXF format, so change the "Files of Type" to \*.dxf

The file "BULK.dxf" is included with the Map3D installation and should be available to import.

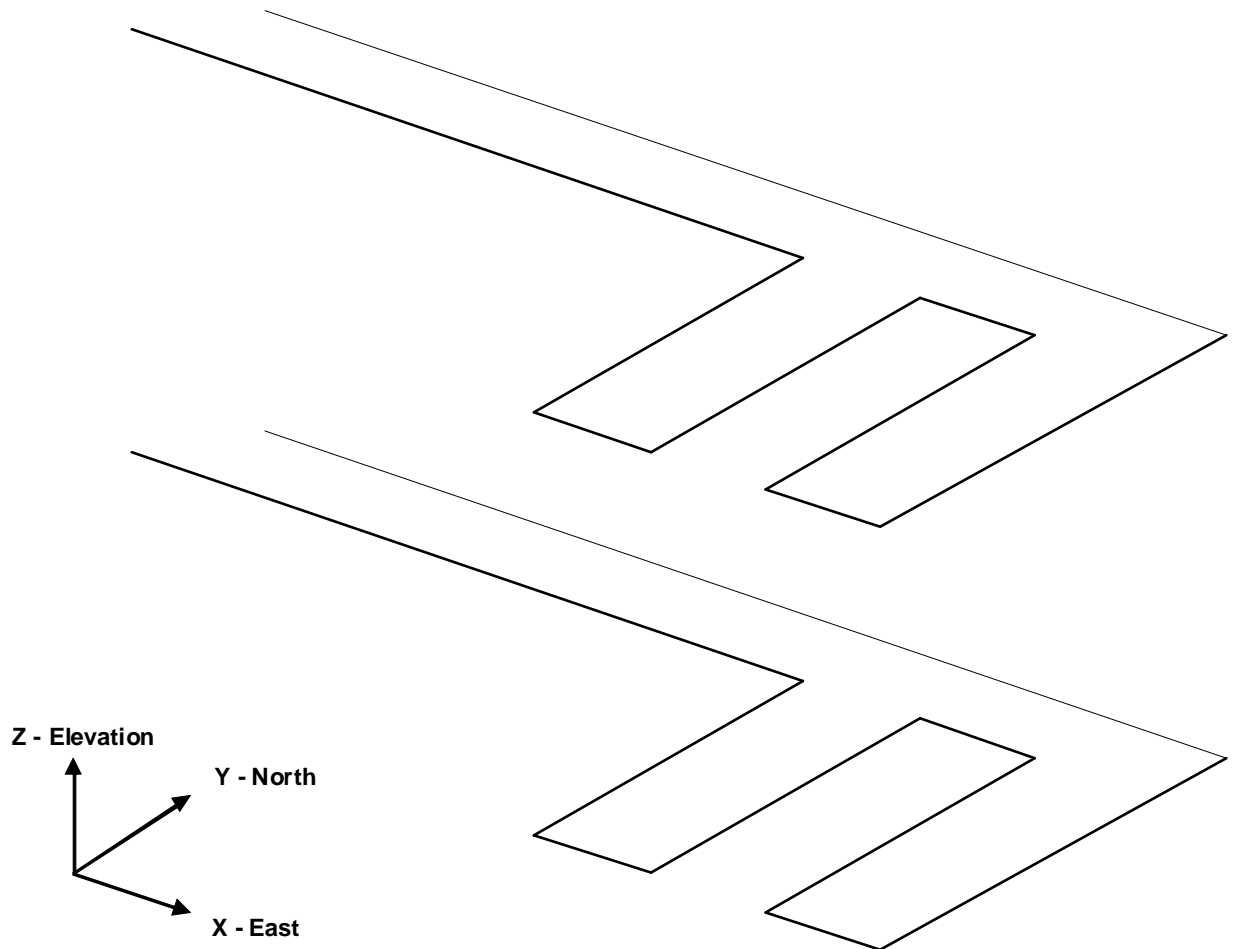

The access drifts measure approximately 5m wide by 5m high, and the distance between levels is 25m.

### Repositioning The View

During block building or at any other time, the user is free to reposition (translate, rotate or zoom) the geometry to make visualization easier. This is readily accomplished by several means (refer to [Rotating the Model](#) and [Translating the Model](#)). The easiest way to rotate is simply hold down the left mouse button will dragging the cursor across the screen. Translation is achieved by holding down the right mouse button. The model can be zooming in or out by holding down both mouse buttons.

Position the view so that the construction lines are readily visible.

## Building Footwall Access Drifts and Cross Cuts

There are numerous methods that can be used to construct these entities. In this tutorial a few different techniques will be demonstrated.

### Building Blocks One at a Time

The simplest (although the most time consuming) approach is to construct a series of 8 cornered blocks one at a time.

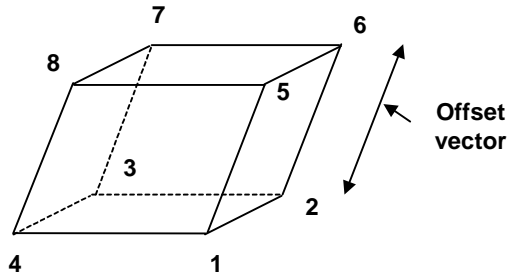

To construct the first block, use [CAD > Build > FFLoop](#). This function can be selected from the [CAD](#) toolbar as follows (activate the [CAD](#) toolbar if it is not visible using [Tools > CAD Toolbar](#)):



Select [CAD > Build](#) from the [CAD](#) toolbar

You will be presented with the sub-menu of build functions



Now select

 [CAD > Build > FFLoop](#)

Since we want to snap to construction lines we must set the snap mode. This is done using [CAD > Snap > Nearest Edge](#). This function can be selected from the [Build Entity](#) toolbar

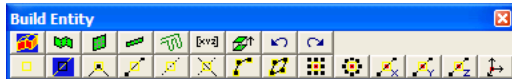

To activate the nearest edge snap select

 [CAD > Snap > Nearest Edge](#)

(this only needs to be done if the nearest edge snap button is not already highlighted ).

In this mode, a pick-box will be displayed at the intersection of the cross-hairs.

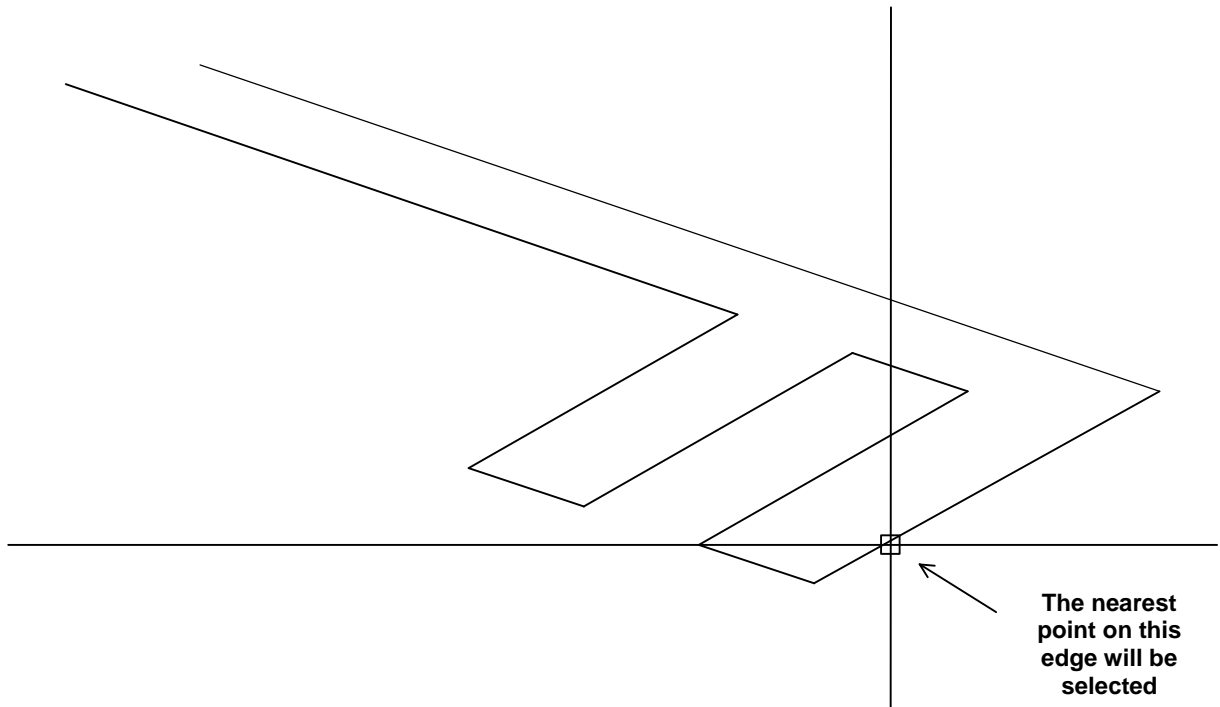

Although the coordinates of the current cursor location are indicated on the status bar, if the pick-box is located over the corner of a construction line, that corner will be selected, otherwise, the nearest point on the edge of the construction line under the pick-box will be selected. In either case all 3 coordinate values (x, y and z) are uniquely specified.

You will see that the [FFLoop](#) building routine is prompting you to enter the first corner of the block on the status bar

Input: Select  
Point 1

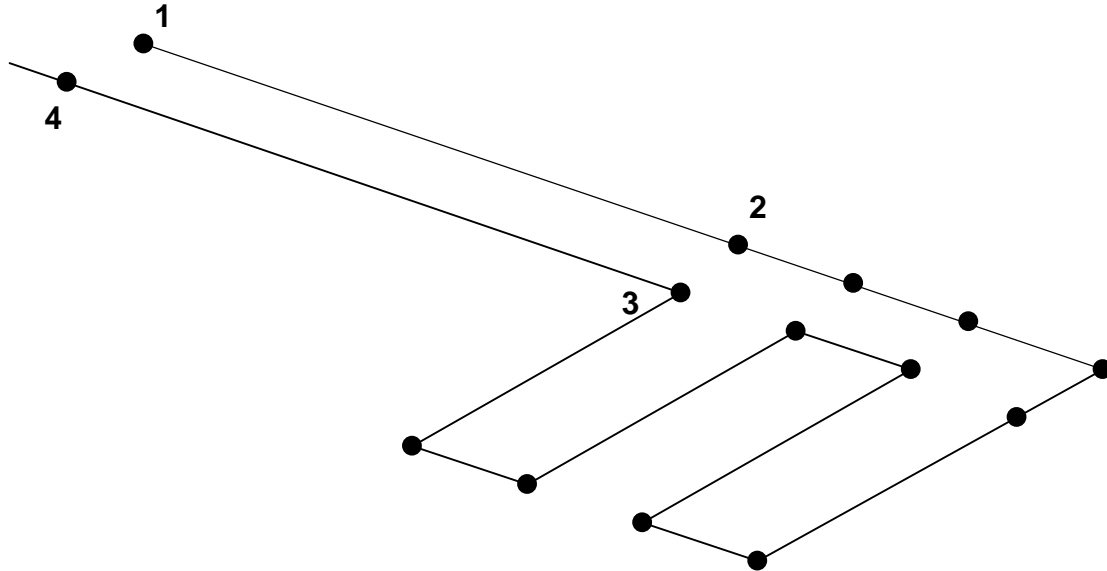

Move the cursor about until you locate point #1. Select this point by clicking the left mouse button once.

You will now be prompted for the next block corner

**Input: Select  
Point 2**

As you move the cursor about you will see that not only is the current cursor location indicated at the lower left hand corner of the display, but also the offset of the current point from the last one selected (i.e. the offset vector from point 1 to point 2). Select point #2. Repeat this selection process for point #3 and #4.

If you select the wrong location for a point, simply undo that selection using the undo button

 [CAD > Build > Undo Point](#) then try again.

Finally, reselect the first point (i.e. point #1).

When first point has been reselected, the base of the block has been completely formed. You will be prompted with the message

**Loop complete: Start  
next loop.**

To complete building the block we will generate the remaining 4 points from the first 4 corners by adding an offset to them. To use this latter procedure, select the offset function from the [Build Entity](#) toolbar

 [CAD > Build > Extrude/Offset Remaining](#)

You will be prompted for this offset vector as follows



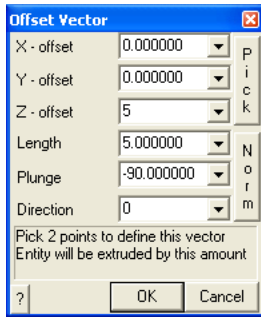



Enter the offset as:

- X-offset > 0
- Y-offset > 0
- Z-offset > 5

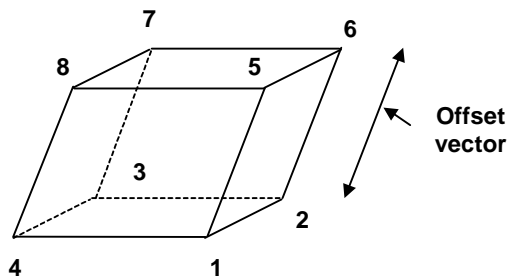
Points 5, 6, 7 and 8 will be generated respectively from points 1, 2, 3 and 4 by adding the offset values to their coordinates.



Upon completion of block construction you will automatically be prompted to enter the block properties (  CAD > Build > FFLoop)

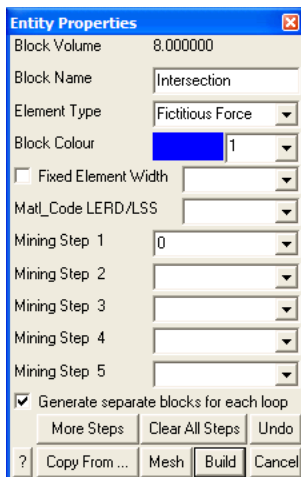

Enter the following:

- Block Name: [Intersection](#)
- Element Type: [Fictitious Force](#)

Block Colour: 1

This intersection block should be excavated at mining step 1. This is indicated by specifying

Mining Step 1: 0

We are now finished and can **Build** this block by pressing the **Build** button.

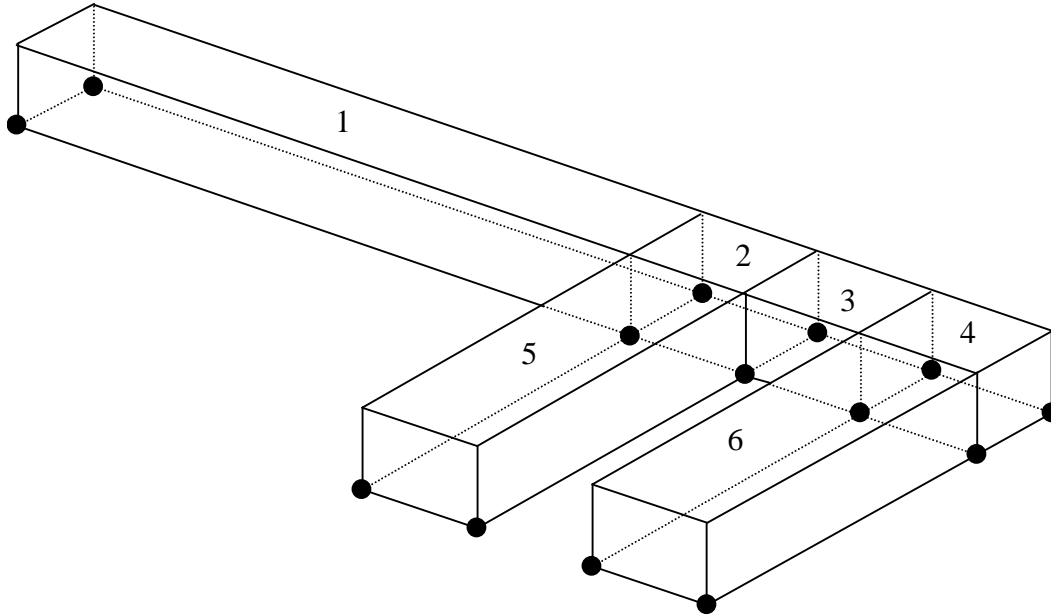

By repeating the above **FFLoop** construction procedure the entire level can be constructed as a series of blocks.

### Building Complex Blocks

Let's now construct more complex shaped blocks.

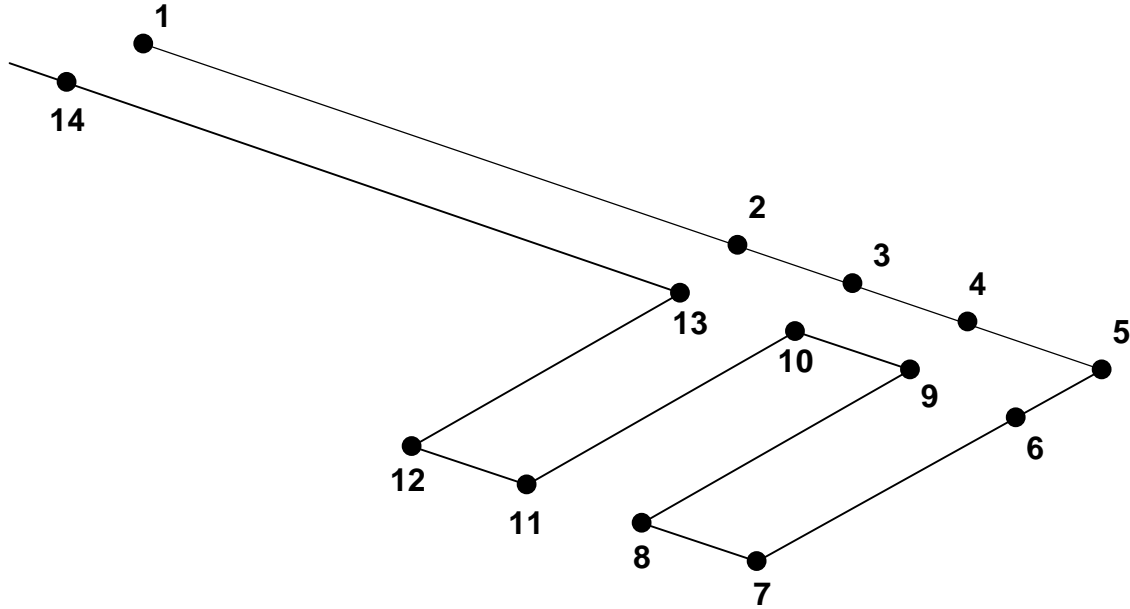

This can be done using the same **FFLoop** construction technique described above, except we will select all 14 points as the floor plan. Once the point #14 has been selected you must reselect point #1 to complete the base of the block. You will be prompted with the message

Loop complete: Start next loop.

To complete building the block select the offset function from the build entity toolbar as before.

 [CAD > Build > Extrude/Offset Remaining](#)

This construction procedure will create one large continuous block covering the entire floor plan. If desired the user could build one block using the point sequence 1-2-3-4-5-6-9-10-13-14-1 to build the hangingwall drive, then 13-10-11-12 and 9-6-7-8 to build the cross-cuts as separate blocks. This later procedure would be desirable if the cross-cuts were to be mined at a different mining step than the hangingwall drive.

Now build the access drifts on the lower level using the same procedure.

### Building VRM Panels

The VRM panels can now be built. These will be constructed using **FFLoop** blocks with 8 corners.

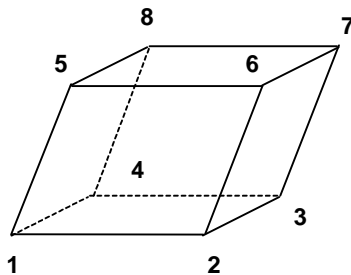

To begin building select

 [CAD > Build > FFLoop](#)

Since we want to snap to corners of previously constructed blocks we must set the snap mode to [CAD > Snap > Nearest Corner](#). This function can be selected from the [Build Entity](#) toolbar



To activate the nearest corner snap select

 [CAD > Snap > Nearest Corner](#)

(this only needs to be done if the nearest edge snap button is not already highlighted ).

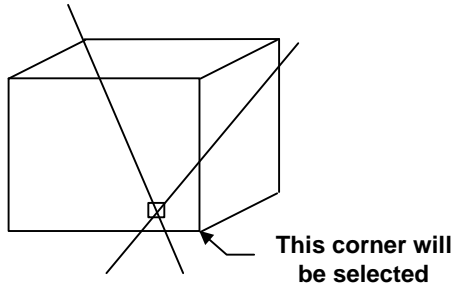

In corner snap mode, a pick-box will be displayed at the intersection of the cross-hairs. The nearest corner on the entity or construction line under the pick-box will be selected (snapped to), thus all 3 coordinate values (x, y and z) are uniquely specified.

We could actually use edge snap mode here

 [CAD > Snap > Nearest Edge](#)

since the corners of the blocks would be selected anyway (as long as the corner is located within the pick box). However, using corner snap allows us to be sloppier with our selection since only corners will be selected.

Select the first 4 points as shown below. Remember to reselect point #1 to complete construction of the floor plan loop.

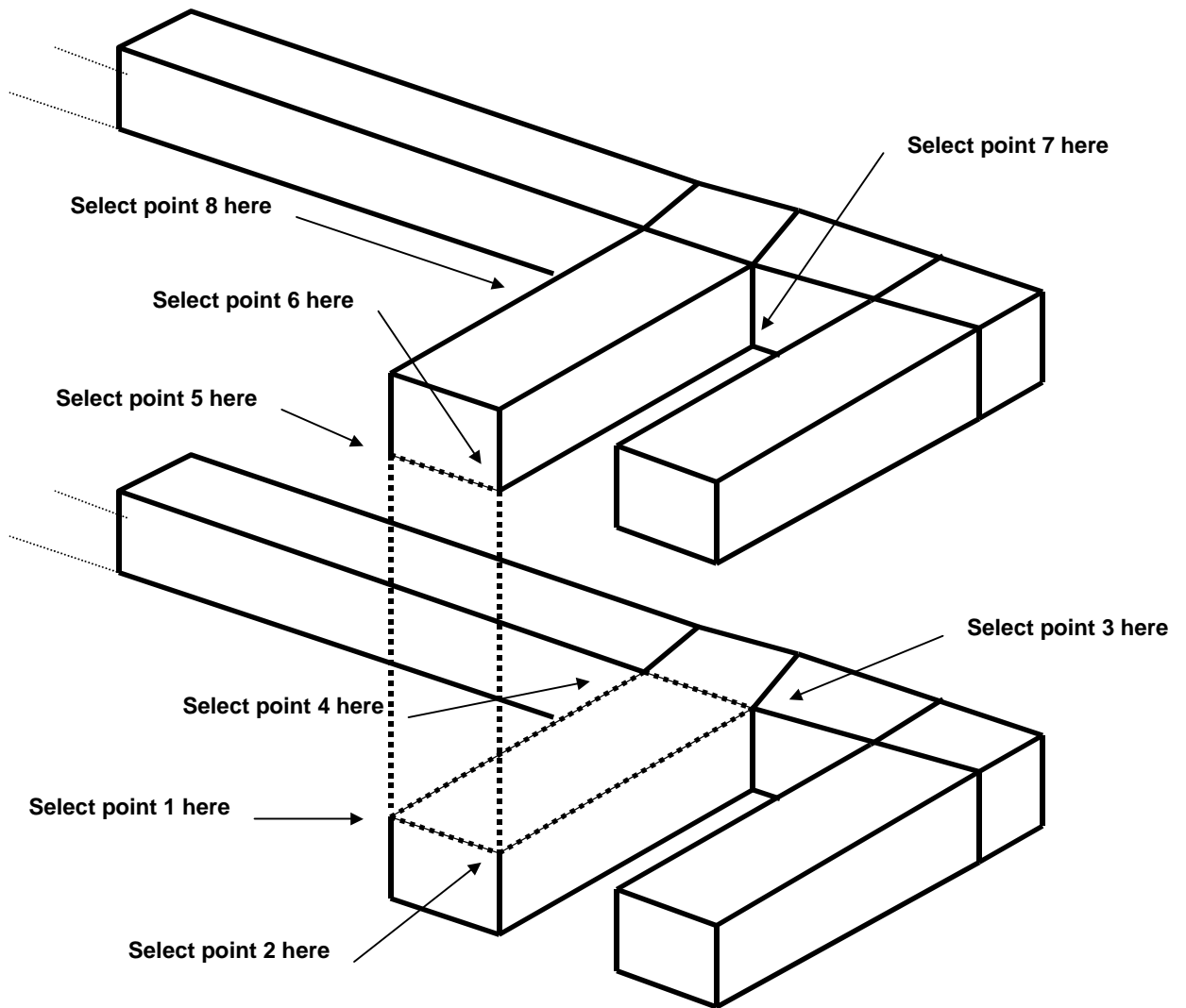

To select points 5 to 8 we will need to rotate the model so we are looking up from below. This is easily done by holding the left mouse button down while dragging the mouse cursor upwards on the screen.

Select points 5 to 8 as shown below. Remember to reselect point #5 to complete construction of the upper plan loop.

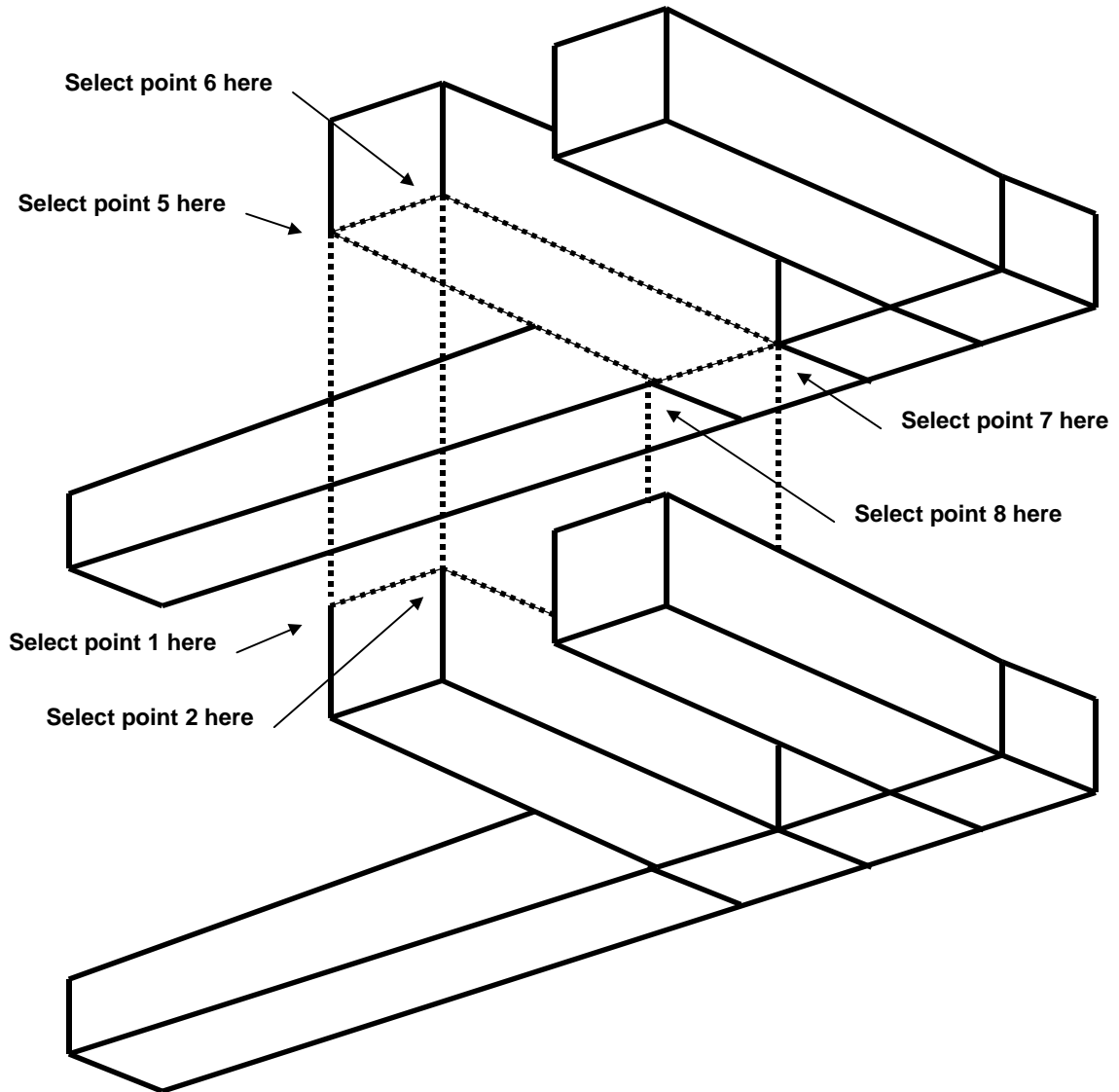

As before you will be prompted with the message

**Loop complete: Start  
next loop.**

To complete building the block select the build button  from the [Build Entity](#) toolbar

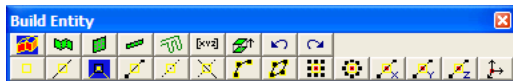

Upon completion of block construction you will automatically be prompted to enter the block properties ( [CAD > Build > FFLoop](#))

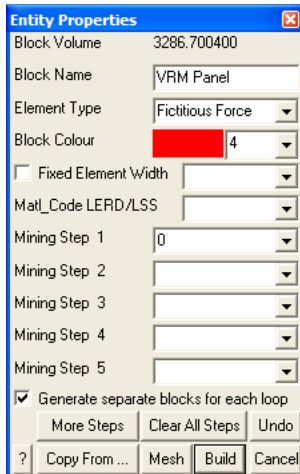

Enter the following:

Block Name: [VRM Panel](#)

Element Type: [Fictitious Force](#)

Block Colour: [4](#)

We will leave this block unmined at step 1 and excavated at step 2. This is indicated by leaving

Mining Step 1: [\(leave this field blank\)](#)

Mining Step 2: [0](#)

We are now finished and can Build this block. The adjacent panel can be constructed using the same procedure giving the final geometry.

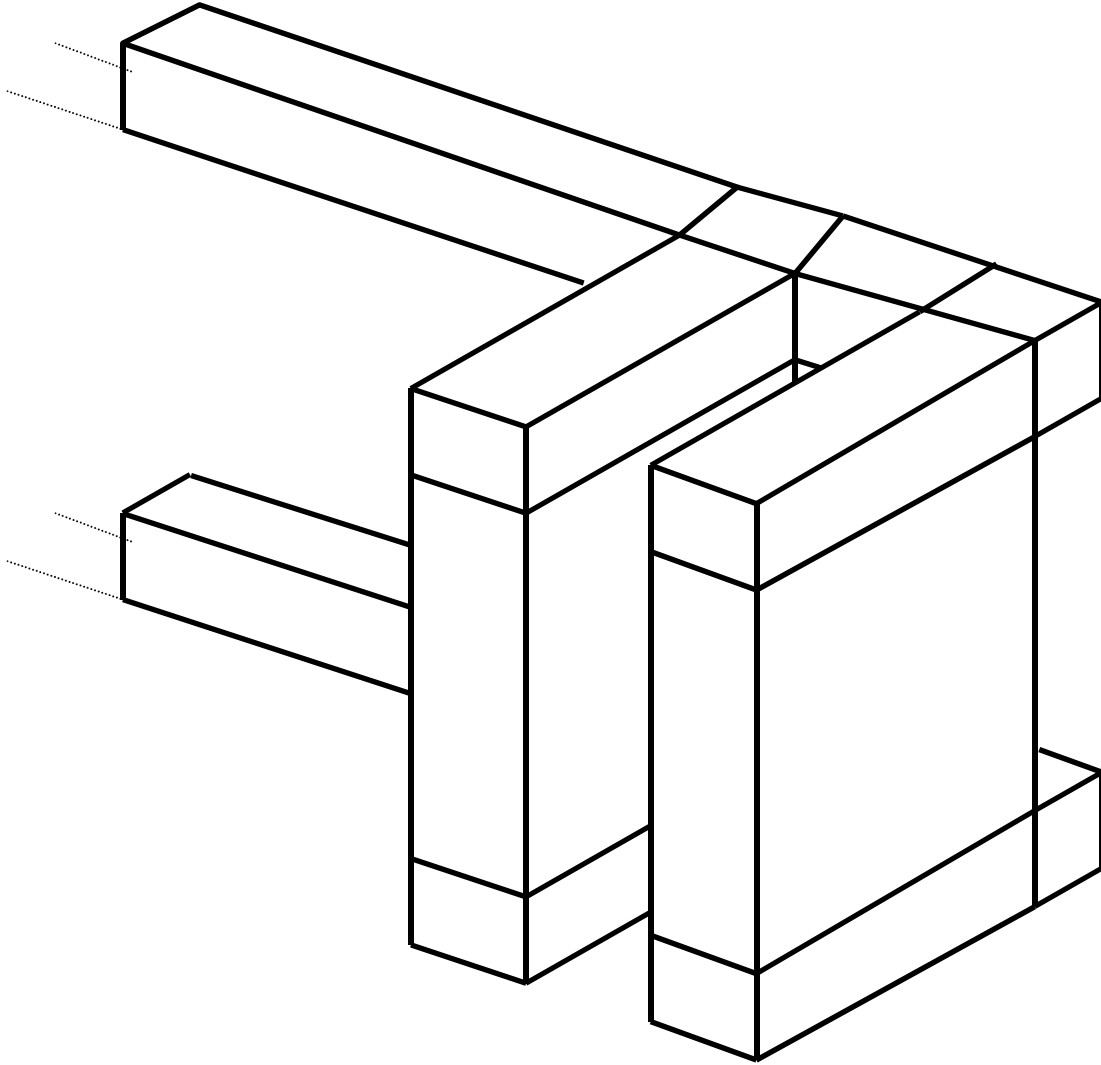

### **Saving the Geometry**

At this point we have constructed the footwall access drifts and two VRM panels. Before proceeding further it would be a good idea to save the model as built so far. To do this we select

[File > Save Model As](#)

Let's save with the name "VRM.INP"

### **Building Grid Planes**

We must now decide where we want results to be calculated. In this example we are interested in the stress in the pillar formed between the two VRM panels. We will therefore define a level grid plane that passes mid-height through the pillar.

We will be using the snap grid function. This can be set up now or after we start the build grid plane function. To set this up now, pick the  button from the [CAD](#) toolbar







Since we are going to be freehand drawing we must set up the snap grid. This is done using [CAD > Snap > Rectangular Grid Snap](#). This function can be selected from the [Snap](#) toolbar



To activate the snap grid select

 [CAD > Snap > Rectangular Grid Snap](#)  
(this only needs to be done if the grid snap button is not already highlighted .

The coordinates of the current cursor location are indicated on the status bar. You will notice that the x and y values change as you move the cursor about, but not the z value. To set the current z value, click on  [CAD > Snap > Cursor/Grid Setup](#), you will be prompted as follows:

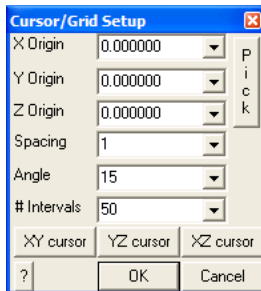

Let's pick this location graphically using the [Pick](#) function.

Since we want the snap base mid height on the VRM panels, change the snap mode to the midpoint of line

 [CAD > Snap > Midpoint of Line](#)

Before proceeding, you must ensure that the correct snap mode has been set either by verifying that the [CAD > Snap > Midpoint of Line](#) menu item is checked, or the midpoint snap button is highlighted .

Select the [Cursor/Snap Base Origin](#) on the vertical edge of the VRM panel.

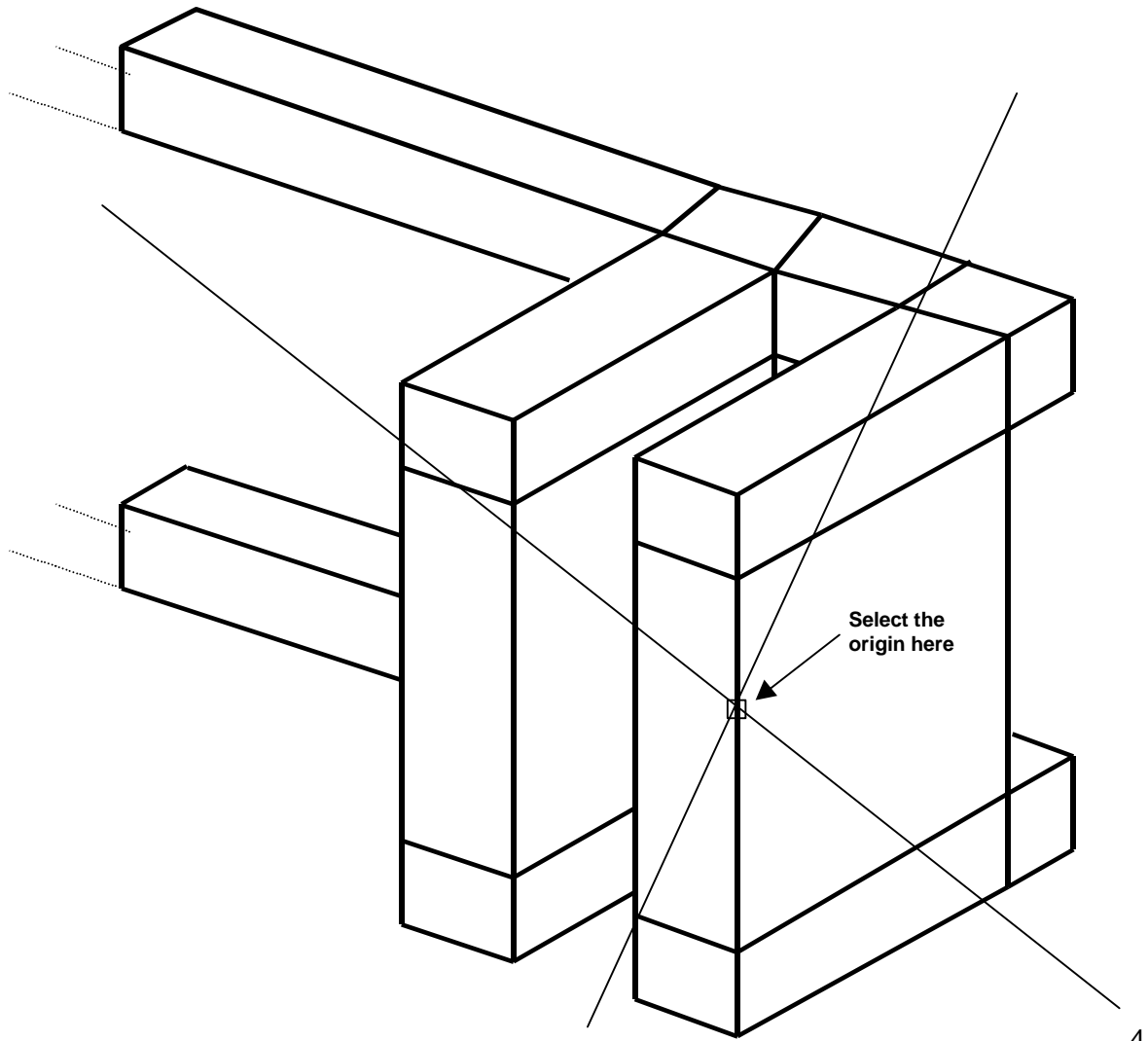

The point mid-height on this edge will be selected. The z value should read

Z Origin: 1012.5

We should also set

**Snap Spacing:** 10

for easier point selection.

If the cursor cross-hairs are not moving the x-y plane, select the  button.

Before beginning construction of the grid plane, we should first reorient the geometry to a plan view. This can be done using

 [View > View XY Plane](#)

Now let's build the grid plane.

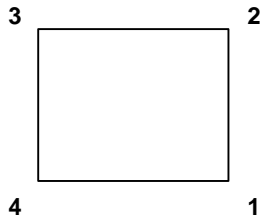

This will be constructed using a plane with 4 corners. To construct this plane, select the grid building menu function

[CAD > Build > Grid Plane](#)

This function can also be selected from the [CAD](#) toolbar as follows:



Select [CAD > Build](#) from the [CAD](#) toolbar

You will be presented with the sub-menu of build functions



Now select

 [CAD > Build > Grid Plane](#)

Since we are going to be freehand drawing we must make sure that [CAD > Snap > Rectangular Grid Snap](#). This function can be selected from the [Build Entity](#) toolbar



To activate the snap grid select

 [CAD > Snap > Rectangular Grid Snap](#)

(this only needs to be done if the grid snap button is not already highlighted .

You will see that the grid plane building routine is prompting you to enter the first corner of the plane

**Input: Select  
Point 1**

Select the four corners of the plane.

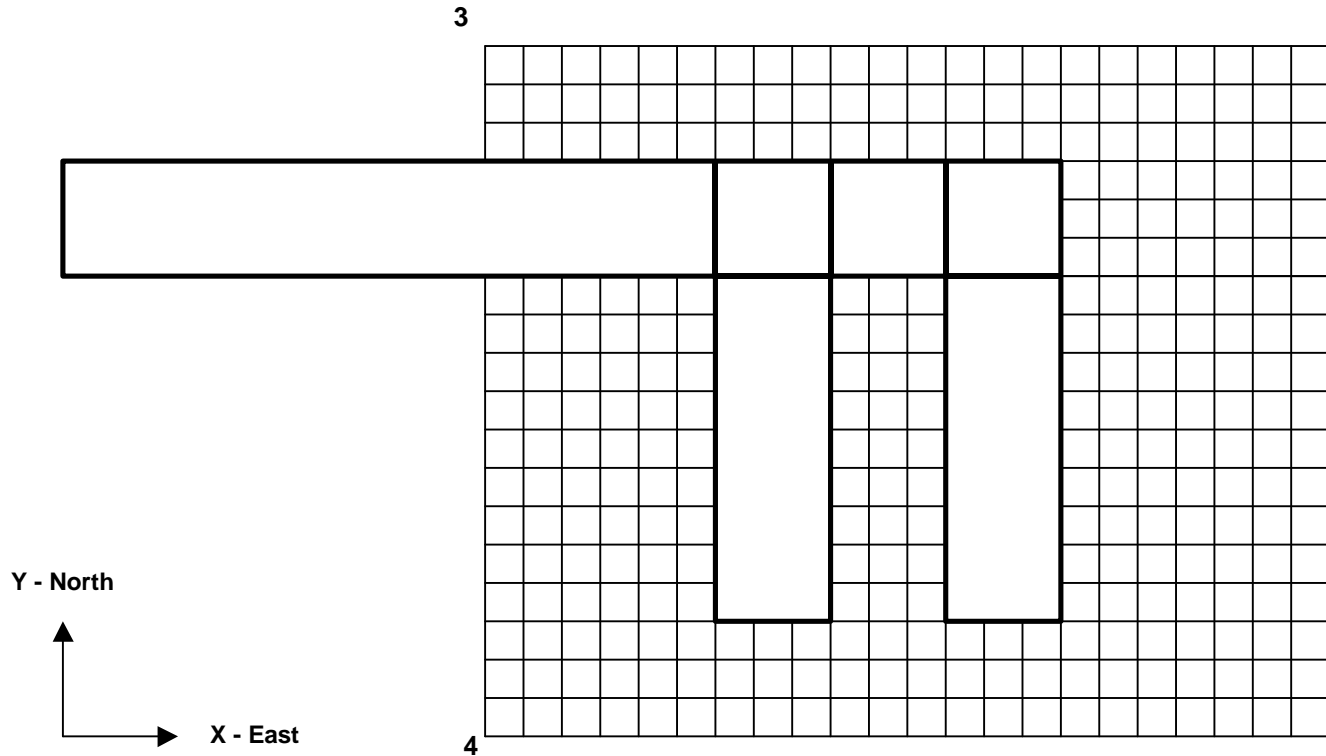

Upon selecting the 4th point, you will automatically be prompted to specify the grid plane properties ( [CAD > Build > Grid Plane](#)).

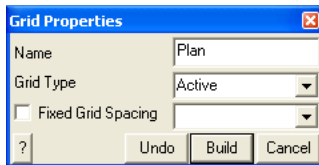

Enter a descriptive **Name** for the grid plane, make sure the **Grid Type** is **Active** and leave the **Fixed Grid Spacing** box unchecked.

### Specifying Material Properties for the Host Rock mass

We must now specify properties for the host material. These are entered using the material properties function

[CAD > Properties > Material Properties](#)

Selecting this item opens a sub-menu of items associated with editing the material properties. Note that material number 1 is by definition the host material. Other material numbers are used to define alternate material zones such as ore, fault gouge, backfill etc. The user is first prompted to enter the material number that is to be edited. First let's define properties for the host material

The dialog box shows the following settings:

	Peak	Residual
Tension Cutoff	0	0
UCS	60	60
Cohesion	0	0
Friction Angle	30	30
Dilation Angle	0	
Young's Modulus	11000	11000
Poisson's Ratio	0.160	0.160
Viscous Mod (Gn)	0	<input checked="" type="radio"/> Elastic only <input type="radio"/> Elasto-Plastic <input type="radio"/> Inactive
Viscous Mod (Gs)	0	
Expansion Coef	1	User Defined Parameters
Conductivity	1	

Buttons: ? Copy from matl... Stress State Close

Enter the following:

Material Name: [Sandstone Host](#)

Material # : 1

Young's Modulus: 60000 MPa

Poisson's Ratio: 0.25

The Viscous Moduli can be set to zero since they are only used to simulate creep response in non-linear analysis.

We want to use the Mohr-Coulomb criterion here. To do this set

Material Type: [Mohr-Coulomb](#)

UCS: 60 MPa

The cohesion parameter is not used in this case and hence can be set to zero.

Friction Angle: 30°

The dilation angle is not used in this case and hence can be set to zero.

The pre-mining stress state can now be specified

Stress State [CAD > Properties > Material Properties > Stress State](#)

The dialog box shows the following settings:

Datum	1000
$\sigma_3$ constant	30
$\sigma_b$ constant	20
$\sigma_c$ constant	20
$\Delta\sigma_3$ variation	-0.027
$\Delta\sigma_b$ variation	-0.013
$\Delta\sigma_c$ variation	-0.013
$\sigma_3$ trend	0
$\sigma_3$ plunge	0
$\sigma_c$ trend	0
t/h constant	0
$\Delta t/h$ variation	0

Buttons: ? Copy from... Cartesian Close

The appropriate far field stress state for this model is

$\sigma_a$  constant: 30 MPa  
 $\sigma_b$  constant: 20 MPa  
 $\sigma_c$  constant: 20 MPa

We will set the variation of stress with depth to zero

$\Delta\sigma_a$  variation: -0.027 MPa/m  
 $\Delta\sigma_b$  variation: -0.013 MPa/m  
 $\Delta\sigma_c$  variation: -0.013 MPa/m

Also the stress orientations (trend and plunge) should be set to zero, thus defining  $\sigma_a$  and  $\sigma_b$  as horizontal and  $\sigma_c$  as vertical.

The Datum can be set to 1000 metres to define the variation with depth as

$$\sigma + \Delta\sigma (z - Datum)$$

Defined in this way, the stress  $\sigma_a$  equals 30 MPa at depth  $z$  equals 1000m, and increases at a rate of 0.027 MPa/m of depth.

### Specifying Control Parameters

We must now specify parameters to control model discretization and solution. These are entered using the control parameters function

[CAD > Properties > Control Parameters](#)

Selecting this item opens a dialog box of items associated with the control parameters

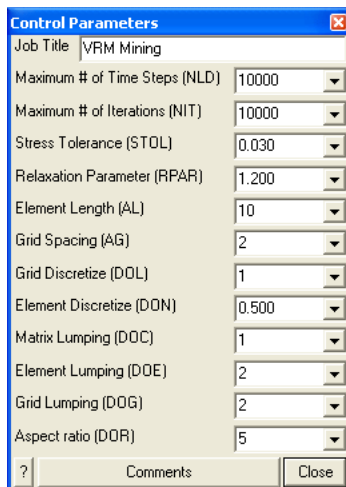

Enter the following:

Job Title: [VRM Mining](#)

All parameters can be left at there default values except the stress tolerance, element length and grid spacing.

Stress Tolerance: [0.03 MPa](#)

should be set to approximately 0.1% of the far field stress state. This ensures that during solution, the surface stresses will be calculated with 0.03 MPa numerical accuracy.

Element Length: [10](#)

should be set equal to twice the drift height or twice the pillar width. This parameter is used to control the minimum boundary element size that will be used at locations where narrow seams or pillars are located. This ensures that a well-conditioned, readily solvable problem will be formulated.

Grid Spacing: 2

should be set to approximately one half the pillar width. This parameter is used to control the minimum boundary element size and the minimum spacing on the grid plane that will be used at locations where it passes close to or intersects the model. Accurate results can be obtained as close as half this spacing from the model surfaces. This parameter also ensures that a sufficient number of stress points will be calculated within in the pillar to generate smooth contours.

The user is free to select a larger value for the grid spacing. This will result in smaller problem size and hence shorter run times. However, with larger boundary elements results will be less accurate, especially near the model surfaces, also with wider grid spacing, smooth contours cannot be generated.

Suggested values for the discretization and lumping parameters are as follows:

*DON=0.5, DOL=DOC=1, DOE=DOG=2 for 10-20% error*

*DON=0.5, DOL=DOC=2, DOE=DOG=4 for 5-10% error*

*DON=1.0, DOL=DOC=4, DOE=DOG=8 for < 5% error*

Coarse analysis results are recommended for all problems except those where increased accuracy is required. At this setting numerical errors of 10-20% in stress predictions can be expected. The settings for detailed analysis results provide 5-10% numerical error. The settings for high accuracy results provide less than 5% numerical error. The user is free to specify higher accuracy settings for these parameters, however this will result in larger problem size and hence longer run times.

### Running a Map3D Analysis

At this point we have completed construction of the model and are ready to begin an analysis. If you are using Map3D Fault-Slip you will obtain an elastic solution to this problem. If you are using Map3D Non-Linear, a complete non-linear analysis will be conducted.

[Analysis](#) is executed from the main menu.

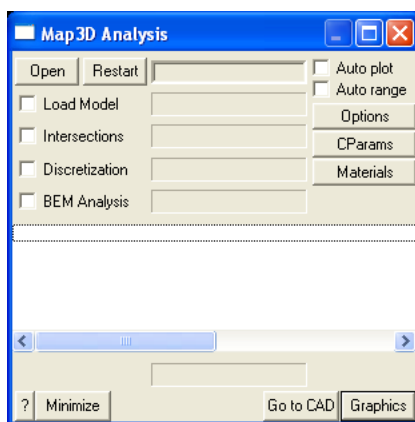

You can run through the complete analysis by selecting

[BEM Analysis](#)

Here we will do this in stages. So first select

### [Discretization](#)

If you have modified the model in any way since the last time you saved, you will be prompted to save these modifications.

When the [Intersections](#) and [Discretization](#) analyses are complete select

[Analysis > Graphics](#)

When in graphical mode, you should select the discretized view option

[View > Render > Discretize](#)

This will enable you to see how the block surfaces have been discretized into boundary elements. You must have set outlines on in order to see the individual elements

[View > Render > Block Outlines](#)

To see how the grid has been discretized (activate the Contour toolbar if it is not visible using [Tools > CAD Toolbar](#)), you must select

 [Plot > Grid Selection > Grid #1](#)

from the contour toolbar

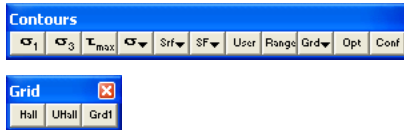

The discretization analysis can be repeated as many times as desired with different values specified for grid spacing, discretization and lumping parameters until the desired density of boundary elements and grids points is achieved.

Once you are satisfied, you can proceed to the BEM Analysis (matrix assembly and solution), by selecting

[Analysis](#)

from the main menu, then selecting

[BEM Analysis](#)

When the analysis is complete, select

[Analysis > Graphics](#)

When in graphical mode, you can contour any desired parameter. For example to display the major principal stress contours, select

 [Plot > Stress > S1](#) Major Principal Stress

This will generate a contour plot on the grid plane.

Interpretation of the results will not be discussed here.

## 3.3 Tabular Mining Example

This example demonstrates model building for a multi-step tabular mining example.

Construction lines are used to define detailed locations of underground features such as excavations, contacts structure etc. A Map3D model is normally built on top of this construction line data.



The mine plans have been previously digitized using Map3D

[CAD > Digitizer Setup](#)

or some other CAD program. These plans can be saved in either:

[Point file format](#) is a universal ASCII data file with the extension ".PNT". This format is useful for exchanging raw construction line data with other CAD software.

[AutoCAD-DXF](#) format is a popular drawing exchange file with the extension ".DXF". This format is useful for exchanging construction line data with other CAD software.

We want to start with a clean slate, so we will select

[File > New Model](#)

Before beginning please note that the user can hover over any button to obtain a tooltip identifying that buttons function. Also the use can right click on any item to obtain detailed help on that function.

### **Importing digitized mine plans**

First we must open a file containing the digitized mine plans. This is done using

[File > Open Construction Lines](#)

In this case the construction lines have been saved in PNT format. The file "TAB.pnt" is included with the Map3D installation and should be available to import.

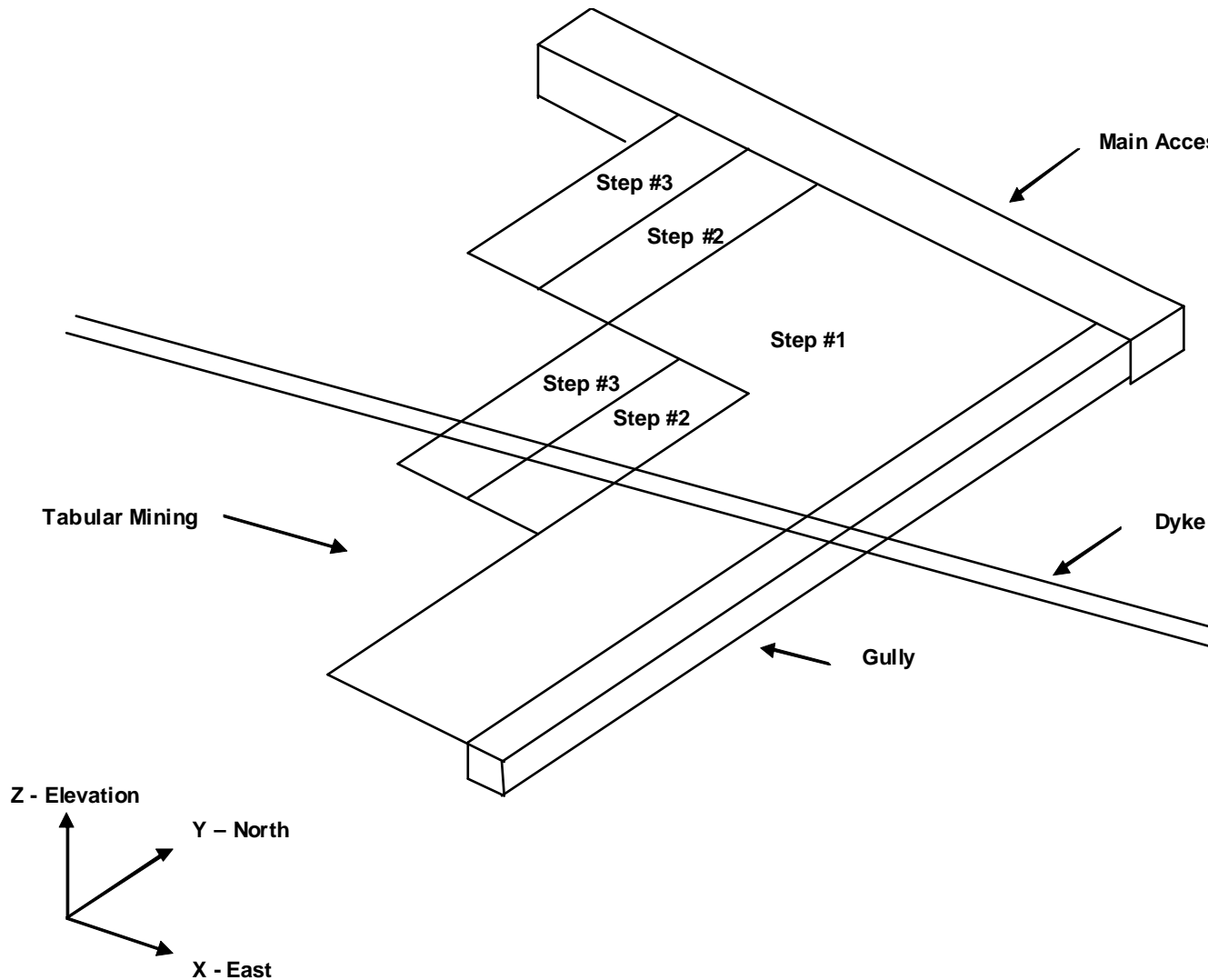

### Repositioning The View

During block building or at any other time, the user is free to reposition (translate, rotate or zoom) the geometry to make visualization easier. This is readily accomplished by several means (refer to [Rotating the Model](#) and [Translating the Model](#)). The easiest way is to rotate is simply hold down the left mouse button will dragging the cursor across the screen. Translation is achieved by holding down the right mouse button. The model can be zooming in or out by holding down both mouse buttons.

Position the view so that the construction lines are readily visible.

### Building Mining Step #1

Let's now construct the tabular mining step #1. This will be constructed using displacement discontinuity elements, which are defined by the perimeter of the mining zone.

To construct the first block, use [CAD > Build > DDLoop](#). This function can be selected from the [CAD](#)

toolbar as follows (activate the [CAD](#) toolbar if it is not visible using [Tools > CAD Toolbar](#)):



Select [CAD > Build](#) from the [CAD](#) toolbar

You will be presented with the sub-menu of build functions



Now select

[CAD > Build > DDLoop](#)

Since we want to snap to construction lines we must set the snap mode. This is done using [CAD > Snap > Nearest Edge](#). This function can be selected from the [Build Entity](#) toolbar

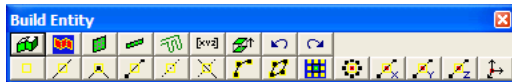

To activate the nearest edge snap select

[CAD > Snap > Nearest Edge](#)

(this only needs to be done if the nearest edge snap button is not already highlighted ).

In this mode, a pick-box will be displayed at the intersection of the cross-hairs. Although the coordinates of the current cursor location are indicated on the status bar, if the pick-box is located over the corner of a construction line, that corner will be selected, otherwise, the nearest point on the edge of the construction line under the pick-box will be selected. In either case all 3 coordinate values (x, y and z) are uniquely specified.

You will see that the [DDLoop](#) building routine is prompting you to enter the first corner of the block on the status bar

**Input: Select  
Point 1**

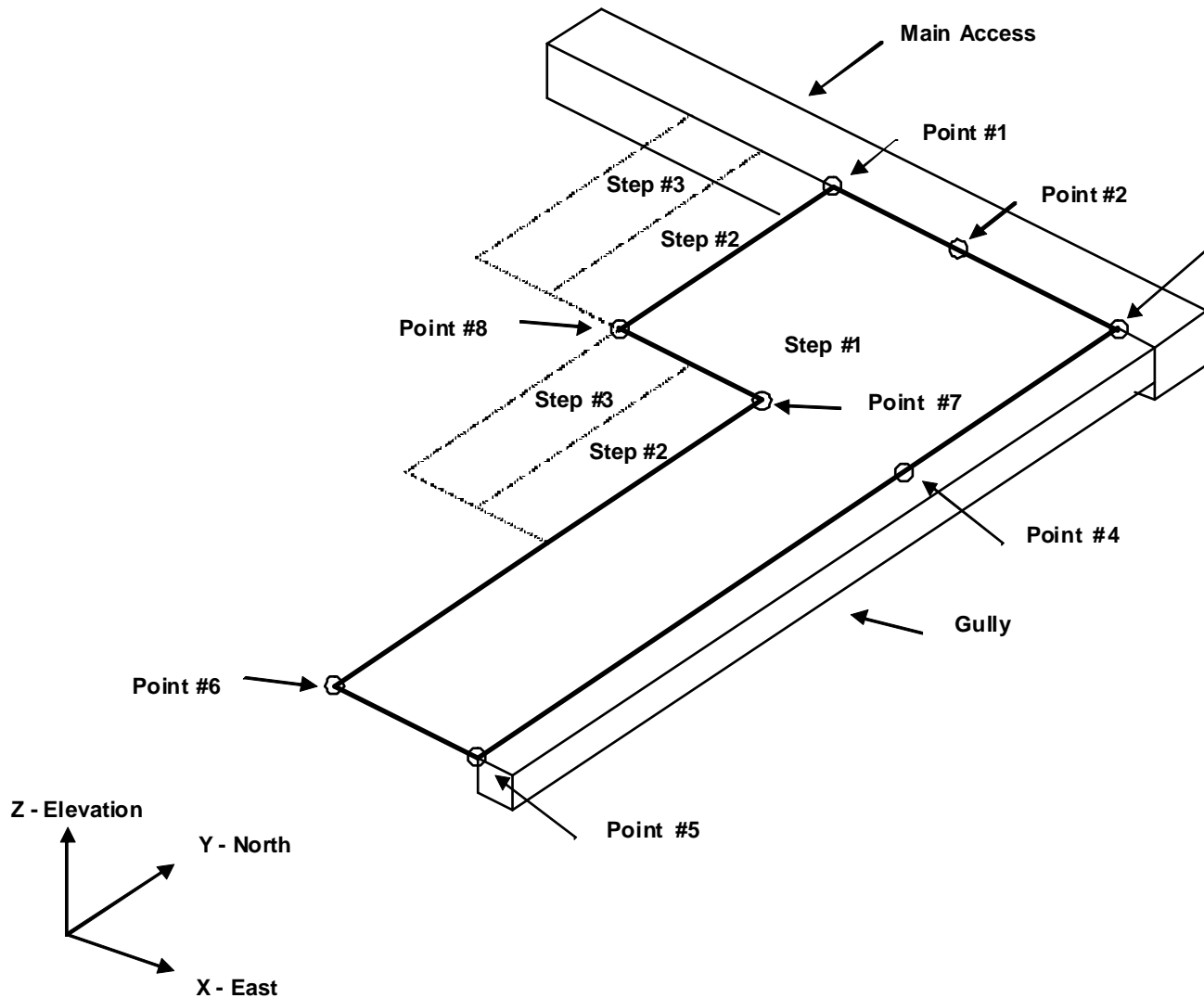

Select the points 1 through 8 as shown.

Note that we could actually use corner snap mode here

 [CAD > Snap > Nearest Corner](#)

for all points except number 2 and 4.

If you select the wrong location for a point, simply undo that selection

 [CAD > Build > Undo Point](#)

then try again.

Points 2 and 4 are optional and have only been selected to generate a neater looking model.

When point #8 has been selected, the floor plan is complete. To complete building the **DDLoop**, select point #1 again or pick the  button.

You will automatically be prompted to enter the block properties ( [CAD > Build > DDLoop](#))

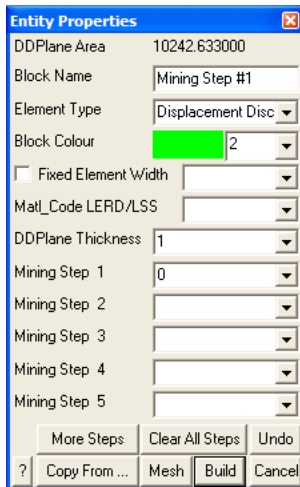

The image shows a screenshot of the 'Entity Properties' dialog box in a software application. The dialog has a blue title bar and a white background. It contains several fields and buttons. The fields are: 'DDPlane Area' with the value '10242.633000', 'Block Name' with 'Mining Step #1', 'Element Type' with 'Displacement Disc', 'Block Colour' with a green color swatch and the number '2', 'Fixed Element Width' (unchecked), 'Matl\_Code LERD/LSS', 'DDPlane Thickness' with '1', and five 'Mining Step' fields (1-5) with values '0', and empty fields. At the bottom, there are buttons for 'More Steps', 'Clear All Steps', 'Undo', '?', 'Copy From ...', 'Mesh', 'Build', and 'Cancel'.

Enter the following:

Block Name: [Mining Step #1](#)  
Element Type: [Displacement Discontinuity](#)  
Block Colour: [2](#)  
DDPlane Thickness: [1](#)

DDPlane Thickness should be set to the mining thickness.

This tabular mining should be excavated at mining step 1. This is indicated by specifying

Mining Step 1: [0](#)

We are now finished and can Build this block by pressing the  button.

## Building Mining Step #2

Let's now construct the tabular mining step #2. This will also be constructed using displacement discontinuity elements, which are defined by the perimeter of the mining zone. To start building select

 [CAD > Build > DDLoop](#)

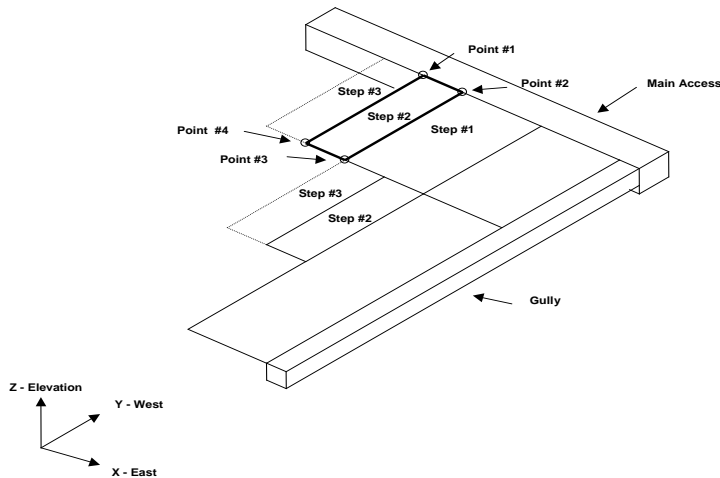

Select the 4 points as shown.

When point 4 has been selected, the floor plan is complete. To complete building the [DDLoop](#), select point #1 again or pick the  button.

You will automatically be prompted to enter the block properties ( [CAD > Build > DDLoop](#))

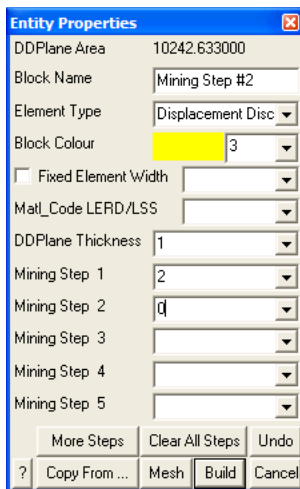

Enter the following:

Block Name: [Mining Step #2](#)  
 Element Type: [Displacement Discontinuity](#)  
 Block Colour: [3](#)  
 DDPlane Thickness: [1](#)

DDPlane Thickness should be set to the mining thickness.

This tabular mining should be assigned the properties of ore (material #2) at mining step 1, then excavated at mining step 2. This is indicated by specifying

Mining Step 1: [2](#)  
 Mining Step 2: [0](#)

We are now finished and can Build this block by pressing the **Build** button.  
 Now build the other part of step 2 using this same procedure.

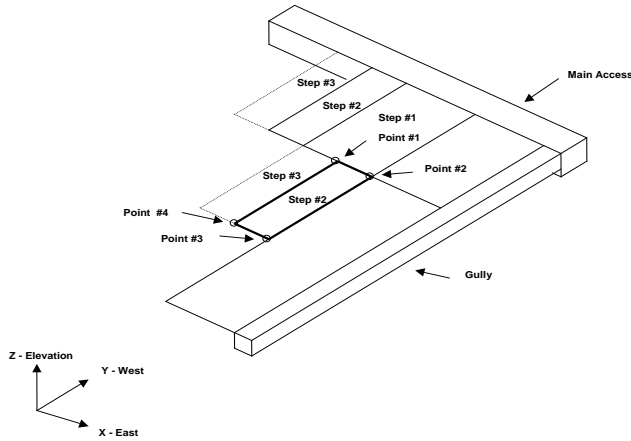

### Building Mining Step #3

This mining can be built the same way as the step 2 mining, except this tabular mining should be assigned the properties of ore (material #2) at both mining step 1 and 2, then excavated at mining step 3.

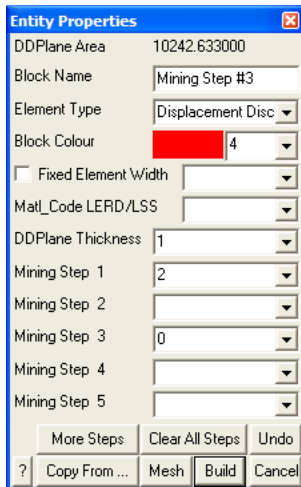

### Getting Results

Even though we have defined the mining geometry, we must still specify where we want to obtain stress predictions. By default, we will get these at all unmined DD planes. If we also want stresses off-reef, or out ahead of the mining zone, we must place either DD planes or grid planes at those locations. Grid planes provide a much more economical (in terms of analysis time) alternative.

In this case we choose to only obtain results on DD planes. We will want to force the discretization on these planes to a suitable element size using the **Fixed Element Width** parameter. To do this, use **CAD > Edit > Properties > Entity Properties**. This function can be selected from the **CAD** toolbar as follows (activate the **CAD** toolbar if it is not visible using **Tools > CAD Toolbar**):



Select [CAD > Edit](#) from the CAD toolbar

You will be presented with the sub-menu of edit functions



Now select

[CAD > Edit > Entity Properties](#)

This will open the edit entities toolbar



When you initiate this routine you will first be prompted to build a list of entities that you wish to edit. Hold the shift key down and pick all of the DD planes that represent the mining steps.

When you have selected all of the mining, you can pick

[CAD > Edit > Entity Properties](#)

again, or double click on any entity to open the Entity Properties dialogue box.

If any of the fields in the dialogue box read "Variable" it is because some of the blocks you have selected have different properties for that field. If you wish to leave these properties as they are (i.e. different for each block), leave the field as "Variable". If you wish to change the value of that field for all selected blocks, enter the desired value.

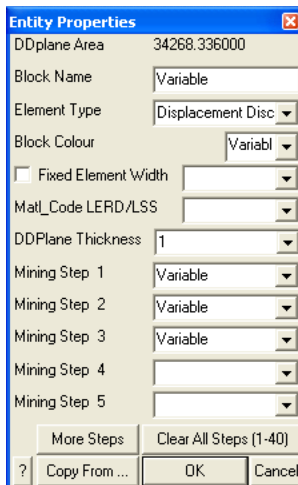

In this case the only field we want to change is the

Fixed Element Width: **20**

Set this value to 20, then select OK.

This will force Map3D to subdivide the mining zone into uniform elements with width 20 metres during the discretization process. This parameter can be set smaller later if a finer discretization is



desired.

### Saving the Geometry

For this example it will be assumed that the geometry as defined thus far is satisfactory. Since both the final geometry and mining sequence are now complete, we should save the model. To do this we select

[File > Save Model As](#)

Let's save with the name "TAB.INP"

### Building The Dyke

As an added complication, let's now build the dyke. To construct the dyke, use [CAD > Build > FFLoop](#). This function can be selected from the [CAD](#) toolbar as follows (activate the [CAD](#) toolbar if it is not visible using [Tools > CAD Toolbar](#)):

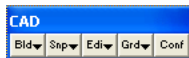

Select [CAD > Build](#) from the [CAD](#) toolbar

You will be presented with the sub-menu of build functions



Now select

[CAD > Build > FFLoop](#)

Since we want to snap to the corners of the construction lines we must set the snap mode. This is done using [CAD > Snap > Nearest Corner](#). This function can be selected from the [Build Entity](#) toolbar

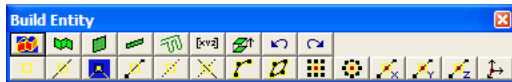

To activate the nearest edge snap select

[CAD > Snap > Nearest Corner](#)

(this only needs to be done if the Nearest Corner Snap button is not already highlighted .

We could actually use edge snap mode here

[CAD > Snap > Nearest Edge](#)

since the corners of the construction lines would be selected anyway (as long as the corner is located within the pick box). However, using corner snap allows us to be sloppier with our selection since only corners will be selected.

Pick all four points as shown in the figure.

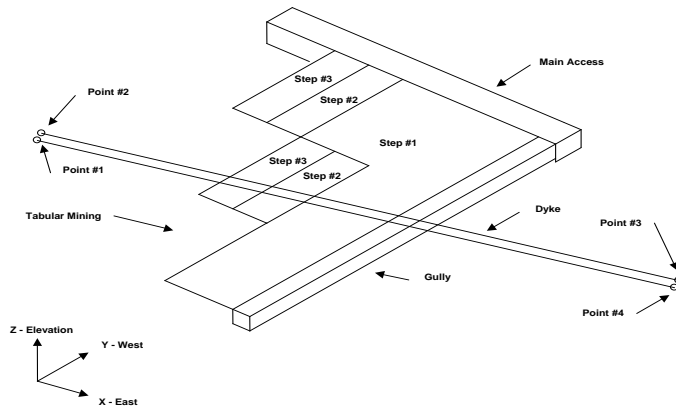

If you select the wrong location for a point, simply undo that selection using the undo button

 [CAD > Build > Undo Point](#) then try again.

Finally, reselect the first point (i.e. point #1).

When first point has been reselected, the base of the block has been completely formed. You will be prompted with the message

**Loop complete: Start next loop.**

To complete building the block we will generate the remaining 4 points from the first 4 corners by adding an offset to them. To use this latter procedure, select the offset function from the [Build Entity](#) toolbar

 [CAD > Build > Extrude/Offset Remaining](#)

You will be prompted for this offset vector as follows

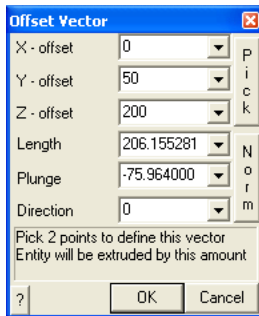

Enter the offset as:

X-offset > 0  
 Y-offset > 50  
 Z-offset > 200

Points 5, 6, 7 and 8 will be generated respectively from points 1, 2, 3 and 4 by adding the offset values to their coordinates.

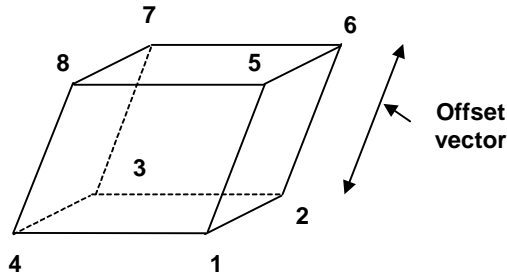

Upon completion of block construction you will automatically be prompted to enter the block properties ( [CAD > Build > FFLoop](#))

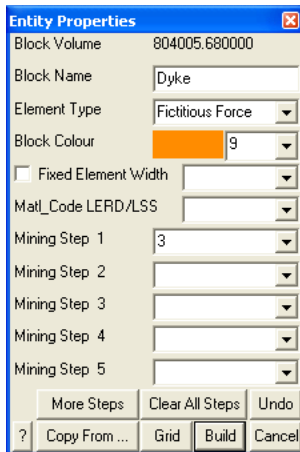

Enter the following:

- Block Name: **Dyke**
- Element Type: **Fictitious Force**
- Block Colour: **9**

The **Fixed Element Width** should be unchecked to disable this feature

This dyke should be assigned material #3 at mining step 1. This is indicated by specifying

Mining Step 1: **3**

We are now finished and can Build this block by pressing the **Build** button.

We need to extend the dyke below the mining as well. To do this we can copy this block below the mining. To do this, select

 [CAD > Edit](#) from the CAD toolbar



This will open the edit toolbar



To copy entities, select

 [CAD > Edit > Copy Entities](#)

This will open the copy entities toolbar



When you initiate this routine you will first be prompted to build a list of entities that you wish to edit. Click on the dyke. This will open the copy offset vector dialogue box

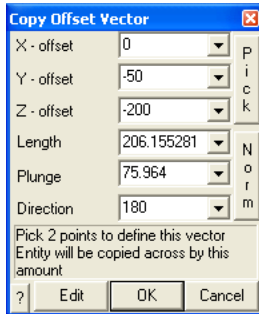

Let's pick this location graphically using the [Pick](#) function.

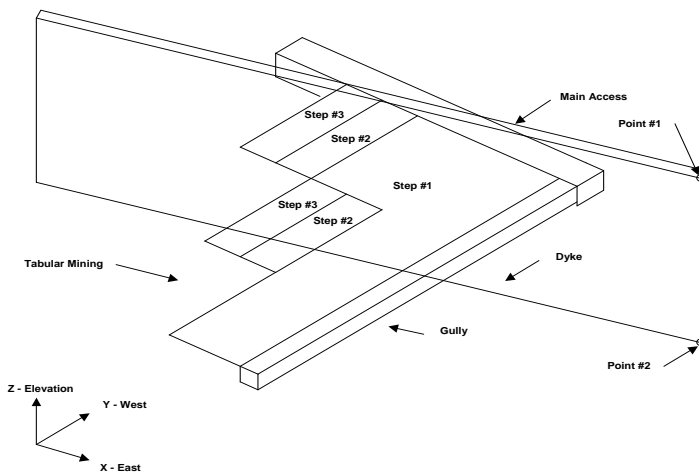

This will define the offset vector

X - offset: 0  
Y - offset: -50  
Z - offset: -200

Now pick OK. This will copy the dyke below the mining.

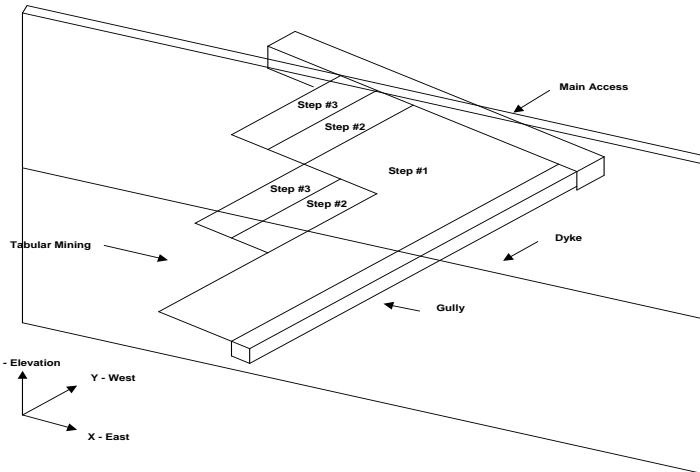

This completes the model construction.

### Specifying Material Properties for the Host Rock mass

We must now specify properties for the host material. These are entered using the material properties function

[CAD > Properties > Material Properties](#)

Selecting this item opens a sub-menu of items associated with editing the material properties. Note that material number 1 is by definition the host material. Other material numbers are used to define alternate material zones such as ore, fault gouge, backfill etc. The user is first prompted to enter the material number that is to be edited. First let's define properties for the host material

Material Properties	
Material Name	Granite Host
Material #	1
Material Type	Mohr-Coulomb
	Peak      Residual
Tension Cutoff	0      0
UCS	60      60
Cohesion	0      0
Friction Angle	30      30
Dilation Angle	0
Young's Modulus	60000      60000
Poisson's Ratio	0.250      0.250
Viscous Mod (Gn)	0 <input checked="" type="radio"/> Elastic only
Viscous Mod (Gs)	0 <input type="radio"/> Elasto-Plastic
Expansion Coef	1 <input type="radio"/> Inactive
Conductivity	1      User Defined Parameters
<input type="button" value="Copy from matl..."/> <input type="button" value="Stress State"/> <input type="button" value="Close"/>	

Enter the following:

Material Name: [Granite Host](#)

Material #: 1

Young's Modulus: [60000 MPa](#)

Poisson's Ratio: [0.25](#)

The Viscous Moduli can be set to zero since they are only used to simulate creep response in non-

linear analysis.

We want to use the Mohr-Coulomb criterion here. To do this set

Material Type: [Mohr-Coulomb](#)

UCS: 60 MPa

The cohesion parameter is not used in this case and hence can be set to zero.

Friction angle: 30°

The dilation angle is not used in this case and hence can be set to zero.

Pick Stress State to open the stress state dialog box

Pre-mining Stress State	
Datum	1000
$\sigma_a$ constant	30
$\sigma_b$ constant	20
$\sigma_c$ constant	20
$\Delta\sigma_a$ variation	-0.02700000
$\Delta\sigma_b$ variation	-0.01300000
$\Delta\sigma_c$ variation	-0.01300000
$\sigma_a$ trend	0
$\sigma_a$ plunge	0
$\sigma_c$ trend	0
t/h constant	0
$\Delta t/h$ variation	0
? Copy from... Cartesian Close	

The appropriate far field stress state for this model is

$\sigma_a$  constant: 30 MPa

$\sigma_b$  constant: 20 MPa

$\sigma_c$  constant: 20 MPa

We will set the variation of stress with depth to zero

$\Delta\sigma_a$  variation: -0.027 MPa/m

$\Delta\sigma_b$  variation: -0.013 MPa/m

$\Delta\sigma_c$  variation: -0.013 MPa/m

Also the stress orientations (trend and plunge) should be set to zero, thus defining  $\sigma_a$  and  $\sigma_b$  as horizontal and  $\sigma_c$  as vertical.

The Datum can be set to 1000 metres to define the variation with depth as

$$\sigma + \Delta\sigma (z - \text{Datum})$$

Defined in this way, the stress  $\sigma_a$  equals 30 MPa at depth  $z$  equals 1000m, and increases at a rate of 0.027 MPa/m of depth.

### Specifying Material Properties for the Ore

We must now specify properties for the ore. These are entered using the material properties function

[CAD > Properties > Material Properties](#)

Selecting this item opens a sub-menu of items associated with editing the material properties. Note that material number 1 is by definition the host material. Other material numbers are used to define

alternate material zones such as ore, fault gouge, backfill etc. The user is first prompted to enter the material number that is to be edited. First let's define properties for the host material

Let's set Material # to 2.

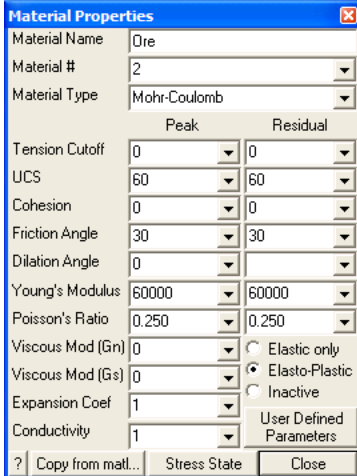

The Material Properties dialog box is shown with the following settings:

	Peak	Residual
Material Name	Ore	
Material #	2	
Material Type	Mohr-Coulomb	
Tension Cutoff	0	0
UCS	60	60
Cohesion	0	0
Friction Angle	30	30
Dilation Angle	0	
Young's Modulus	60000	60000
Poisson's Ratio	0.250	0.250
Viscous Mod (Gn)	0	
Viscous Mod (Gs)	0	
Expansion Coef	1	
Conductivity	1	
Behavior	Elastic only (unchecked), Elasto-Plastic (checked), Inactive (unchecked)	
Parameters	User Defined Parameters	

Buttons: Copy from matl..., Stress State, Close

All parameters can be set as desired. The user should take special care in this case since this material is inserted into DD planes. These features can behave non-linearly yielding in compression and shearing (refer to the section on [Mohr-Coulomb in DD Planes](#)).

Pick Stress State to open the stress state dialog box

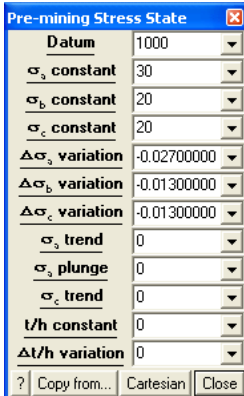

The Pre-mining Stress State dialog box is shown with the following settings:

Datum	1000
$\sigma_x$ constant	30
$\sigma_y$ constant	20
$\sigma_z$ constant	20
$\Delta\sigma_x$ variation	-0.02700000
$\Delta\sigma_y$ variation	-0.01300000
$\Delta\sigma_z$ variation	-0.01300000
$\sigma_x$ trend	0
$\sigma_y$ plunge	0
$\sigma_z$ trend	0
t/h constant	0
$\Delta t/h$ variation	0

Buttons: Copy from..., Cartesian, Close

We want the initial stress in the ore to be the same as in the host, so let's Copy from material 1.

### Specifying Material Properties for the Dyke

We must now specify properties for the dyke. These are entered using the material properties function

[CAD > Properties > Material Properties](#)

Selecting this item opens a sub-menu of items associated with editing the material properties. Note that material number 1 is by definition the host material. Other material numbers are used to define alternate material zones such as ore, fault gouge, backfill etc. The user is first prompted to enter the material number that is to be edited. First let's define properties for the host material

Let's set Material # to 3.

All parameters can be set as desired. If Map3D Non-Linear is being used, the user should take special care in this case since this feature can behave non-linearly yielding in compression and shearing (refer to the section on [Mohr-Coulomb in 3D FF Blocks](#)).

Be sure to Pick Stress State to open the stress state dialog box, as set the stress state in the dyke to be the same as in the host (Copy from material 1).

### Specifying Control Parameters

We must now specify parameters to control model discretization and solution. These are entered using the control parameters function

[CAD > Properties > Control Parameters](#)

Selecting this item opens a dialog box of items associated with the control parameters

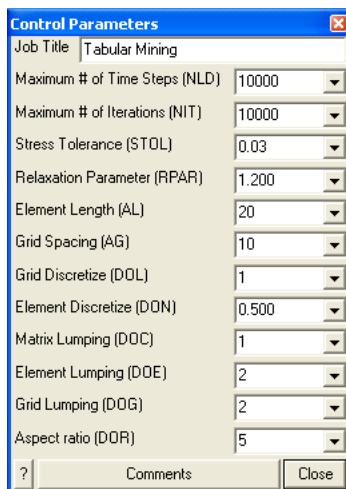

Enter the following:

Job Title: [Tabular Mining](#)

All parameters can be left at their default values except the stress tolerance, element length and grid spacing.

Stress Tolerance: [0.03 MPa](#)

should be set to approximately 0.1% of the far field stress state. This ensures that during solution, the surface stresses will be calculated with 0.03 MPa numerical accuracy.

Element Length: [20](#)

should be set equal to twice the thickness of the Dyke (the dyke is 10 metres thick) since this is the narrowest feature used in this model. This parameter is used to control the minimum boundary element size that will be used at locations where narrow seams or pillars are located. This ensures that a well-conditioned, readily solvable problem will be formulated.

The Grid Spacing is not used since we have not defined any field point grids.

Suggested values for the discretization and lumping parameters are as follows:

[DON=0.5, DOL=DOC=1, DOE=DOG=2](#) for 10-20% error

[DON=0.5, DOL=DOC=2, DOE=DOG=4](#) for 5-10% error



[DON=1.0, DOL=DOC=4, DOE=DOG=8 for < 5% error](#)

Coarse analysis results are recommended for all problems except those where increased accuracy is required. At this setting numerical errors of 10-20% in stress predictions can be expected. The settings for detailed analysis results provide 5-10% numerical error. The settings for high accuracy results provide less than 5% numerical error. The user is free to specify higher accuracy settings for these parameters, however this will result in larger problem size and hence longer run times.

### Running a Map3D Analysis

At this point we have completed construction of the model and are ready to begin an analysis. If you are using Map3D Fault-Slip you will obtain an elastic solution to this problem. If you are using Map3D Non-Linear, a complete non-linear analysis will be conducted.

[Analysis](#) is executed from the main menu.

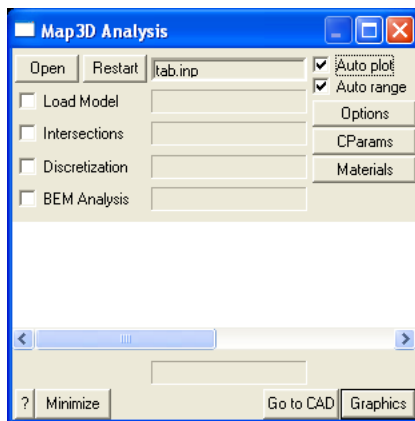

You can run through the complete analysis by selecting

[BEM Analysis](#)

here we will do this in stages. So first select

[Discretization](#)

If you have modified the model in any way since the last time you saved, you will be prompted to save these modifications.

When the [Intersections](#) and [Discretization](#) analyses are complete select

[Analysis > Graphics](#)

When in graphical mode, you should select the discretized view option

[View > Render > Discretize](#)

This will enable you to see how the block surfaces have been discretized into boundary elements. You must have set outlines on in order to see the individual elements

[View > Render > Block Outlines](#)

To see how the grid has been discretized, you must select the

[Plot > Grid Selection > Grid #1](#)

If everything is satisfactory, you can now proceed to the BEM Analysis (matrix assembly and solution), by selecting

### [Analysis](#)

from the main menu, then selecting

#### [BEM Analysis](#)

When the analysis is complete, select

#### [Analysis > Graphics](#)

When in graphical mode, you can contour any desired parameter. For example to display the normal displacement (closure) on the tabular mining, select

#### [Plot > Surface Components > Dn Normal Displacement \(Closure\)](#)

This will generate a contour plot on the DD planes.

### **Building The Main Access**

This will be built by drawing a floor plan with [DDLooP](#) then extruding this into a 3D block.

To do this we must return to the CAD stage of the Map3D analysis by selecting

#### [Analysis > Go to CAD](#)

from the analysis dialogue box. Then select

#### [Analysis > Graphics](#)

To begin, select the [DDLooP](#) building menu function

#### [CAD > Build > DD Loop](#)

Set the snap mode to nearest edge (or nearest corner)

#### [CAD > Snap > Nearest Edge](#)

this only needs to be done if the edge snap button is not already highlighted .

You will see that the [DDLooP](#) building routine is prompting you to enter the first corner of the block on the status bar

**Input: Select  
Point 1**

Pick the first two points as shown in the figure.

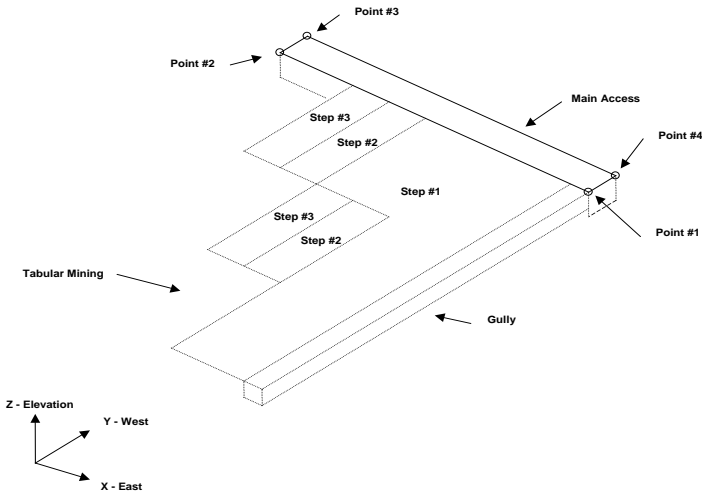

Points 3 and 4 will be generated by offsetting them from the line defined by points 1 and 2. To do this select

 [CAD > Build > Offset Remaining](#)

from either the build toolbar.

You will be prompted to enter the offset vector.

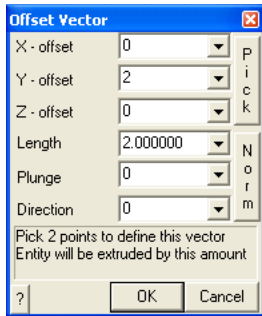

Enter the offset as

- X - offset: 0
- Y - offset: 2
- Z - offset: 0

This will generate points 3 and 4 and complete building the [DDLloop](#).

You will automatically be prompted to enter the block properties

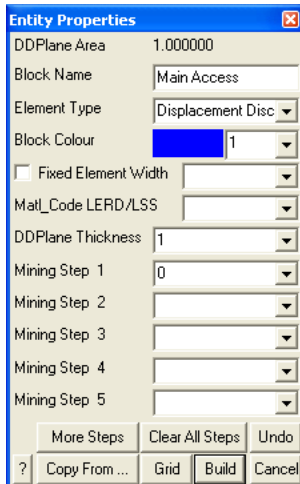

Enter the following:

Block Name: **Main Access**

Element Type: **Fictitious Force**

When you do this you will be prompted to enter the offset vector that will be used to extrude the block.

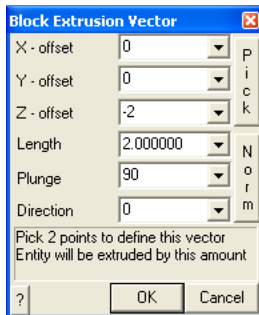
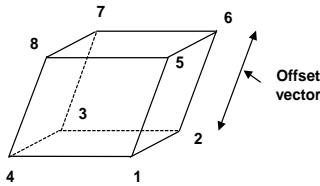

Enter the offset as:

X - offset: **0**

Y - offset: **0**

Z - offset: **-2**

Block Colour: **1**

Fixed Element Width: (leave this unchecked)

This access should be excavated at mining step 1. This is indicated by specifying

Mining Step 1: **0**

We are now finished and can Build this block.

**Building The Gully**

Now build the gully using the same procedure as described above.

Pick the first two points as shown in the figure.

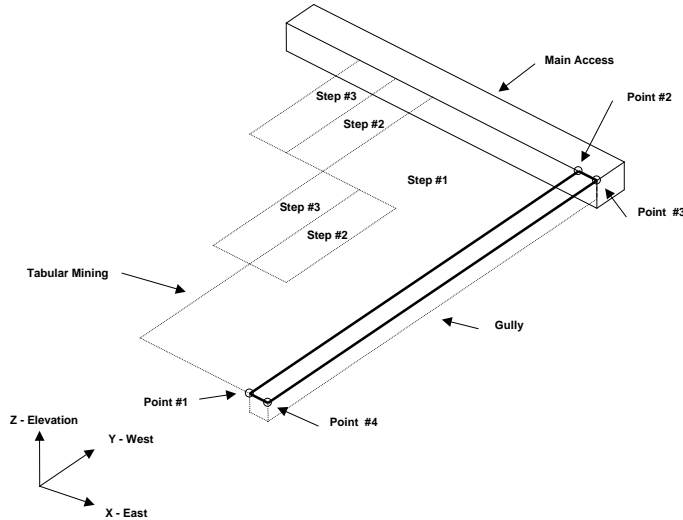

Points 3 and 4 will be generated by offsetting them from the line defined by points 1 and 2. To do this select

 [CAD > Build > Offset Remaining](#)

from either the build toolbar.

You will be prompted to enter the offset vector.

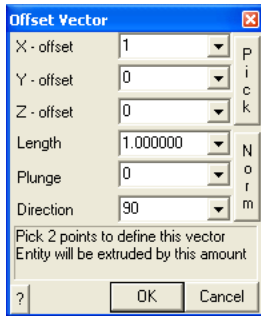

Enter the offset as:

- X - offset: 1
- Y - offset: 0
- Z - offset: 0

This will generate points 3 and 4 and complete building the [DDLoop](#).

You will automatically be prompted to enter the block properties

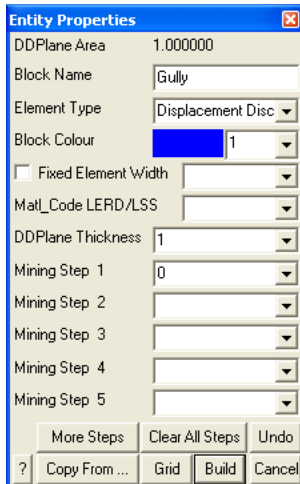

The Entity Properties dialog box contains the following fields and controls:

- DDPlane Area: 1.000000
- Block Name: Gully
- Element Type: Displacement Disc
- Block Colour: 1
- Fixed Element Width: (unchecked)
- Mat\_Code LEFD/LSS: (empty)
- DDPlane Thickness: 1
- Mining Step 1: 0
- Mining Step 2: (empty)
- Mining Step 3: (empty)
- Mining Step 4: (empty)
- Mining Step 5: (empty)
- Buttons: More Steps, Clear All Steps, Undo, Copy From ..., Grid, Build, Cancel

Enter the following:

Block Name: **Gully**  
 Element Type: **Fictitious Force**

When you do this you will be prompted to enter the offset vector that will be used to extrude the block.

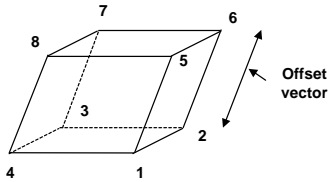
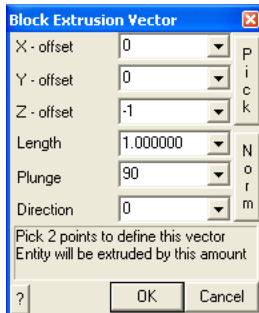
The Block Extrusion Vector dialog box contains the following fields and controls:

- X - offset: 0
- Y - offset: 0
- Z - offset: -1
- Length: 1.000000
- Plunge: 90
- Direction: 0
- Buttons: Pick 2 points to define this vector, Entity will be extruded by this amount, OK, Cancel

Enter the offset as:

X - offset: **0**  
 Y - offset: **0**  
 Z - offset: **-1**

Block Colour: **1**  
 Fixed Element Width: (leave this unchecked)

This access should be excavated at mining step 1. This is indicated by specifying

Mining Step 1: **0**

We are now finished and can Build this block.

### Discussion

Before proceeding with the analysis we must modify the [Element Length \(AL\)](#) control parameter to accommodate these new additions to our model properly

[CAD > Properties > Control Parameters](#)

AL should be set equal to twice the thickness of the gully (the gully is 1 metres thick) since this is the narrowest feature used in this model.

If we now discretize the model

[Analysis > Discretization](#)

a careful look illustrates that a large number of boundary elements are used in discretizing the areas adjacent to the gully and main access. These features are clearly going to be expensive in terms of analysis time. If these features are not important contributing factors considerable saving in analysis effort can be achieved by removing them from the analysis. This can be achieved by making these features inactive.

To do this select

[Analysis > Go to CAD](#)

from the analysis dialogue box. Then select

[Analysis > Graphics](#)

Now select



from the CAD toolbar



This will open the edit toolbar



To edit entities, select

 [CAD > Edit > Entity Properties](#)

This will open the edit entities toolbar



When you initiate this routine you will first be prompted to build a list of entities that you wish to edit. Hold down the Shift key then pick the Gully and Main Access. Do not pick the tabular mining or dyke.

When you have selected these features, you can pick

 [CAD > Edit > Entity Properties](#)

again, or double click on the Gully or Main Access to open the Entity Properties dialogue box.

If any of the fields in the dialogue box read "Variable" it is because some of the blocks you have selected have different properties for that field. If you wish to leave these properties as they are (i.e. different for each block), leave the field as "Variable". If you wish to change the value of that field for all selected blocks, enter the desired value.

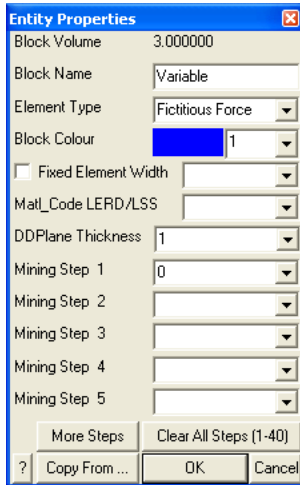

In this case the only field we want to change is the Element Type parameter. Set this to Inactive Fictitious Force

Element Type: [Inactive Fictitious Force](#)

then select OK.

You can now start the BEM analysis again by selecting

[BEM Analysis](#)

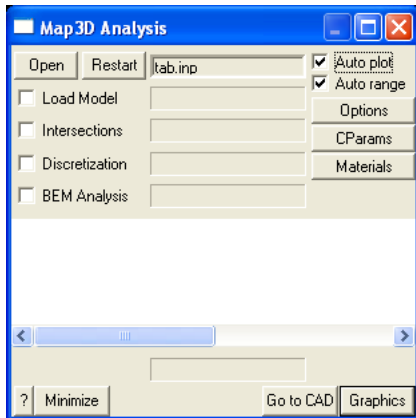

### 3.4 DDLoop Pillar Example

#### Step 1: Import digitized mine plans.

- The plans for this example are in a file called "t.pnt".
- These are imported using the [File > Open Construction Lines](#) command.



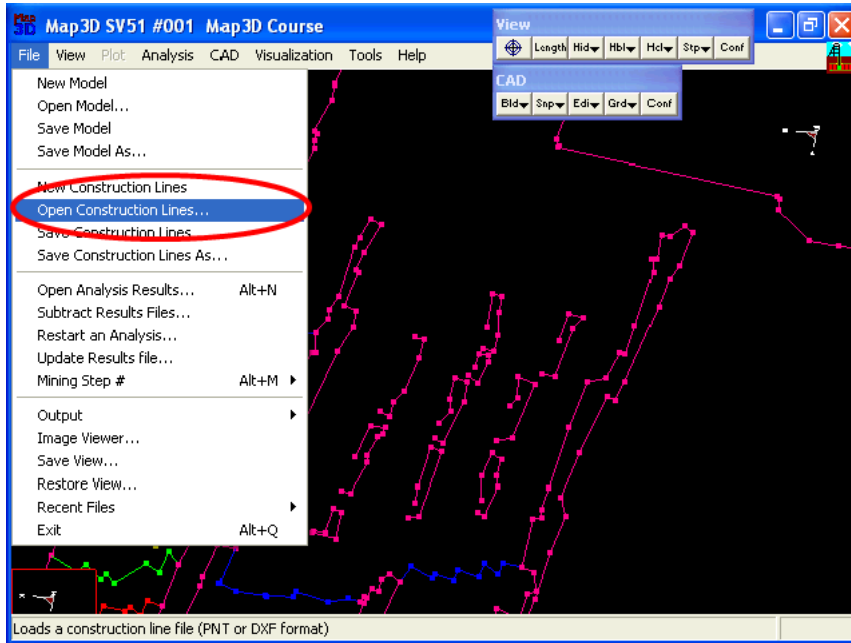

**Step 2: Next we start the DDLoop routine and set the CLine snap mode.**

- DDLoop can be started by selecting **Bld** then  (CAD > Build > DDLoop).
- CLine snap mode can be set by selecting  (CAD > Snap > Trace CLine).

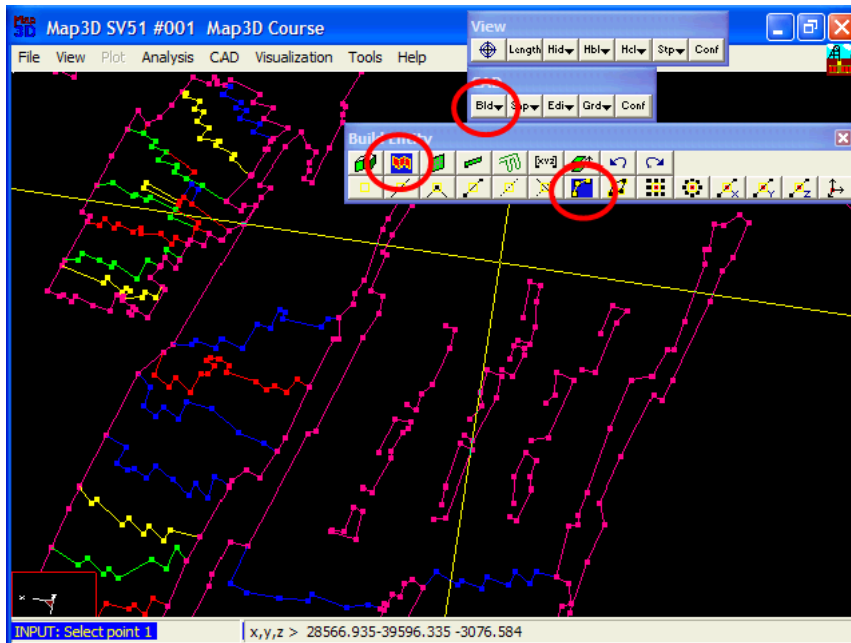

**Step 3: Build the outer loop.**

- The outer loop is built by selecting the end points of the desired construction line segments.

- Here we pick point 1-2-3-4-5-6-1
- Point 1 is picked at the end of this sequence to close the loop, thus completing construction of the outer loop.

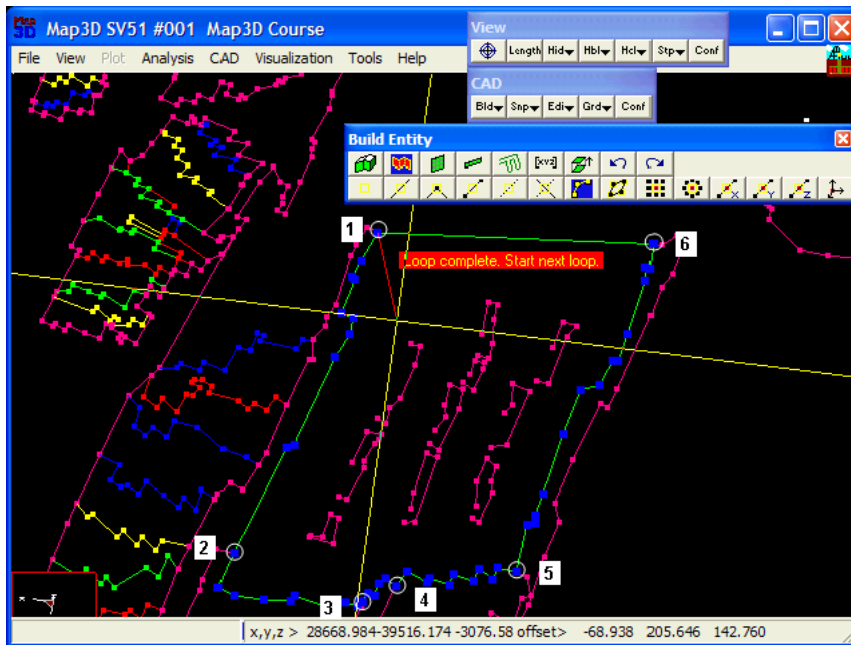

#### Step 4: Set the snap mode to CLoop then build the inner loops.

- CLoop snap mode can be set by selecting  (CAD > Snap > Trace CLoop).
- The inner loops are defined by picking the entry and exit points for each loop.
- The 1st loop is defined by points 1 and 2.
- The 2nd loop is defined by points 3 and 4.
- The 3rd loop is defined by point 5.
- The 4th loop is defined by points 6 and 7.
- The 5th loop is defined by points 8 and 9.
- The 6th loop is defined by points 10 and 11.
- The 7th loop is defined by point 12.
- The 8th loop is defined by point 13.
- The 9th loop is defined by points 14 and 15.
- The 10th loop is defined by point 16.

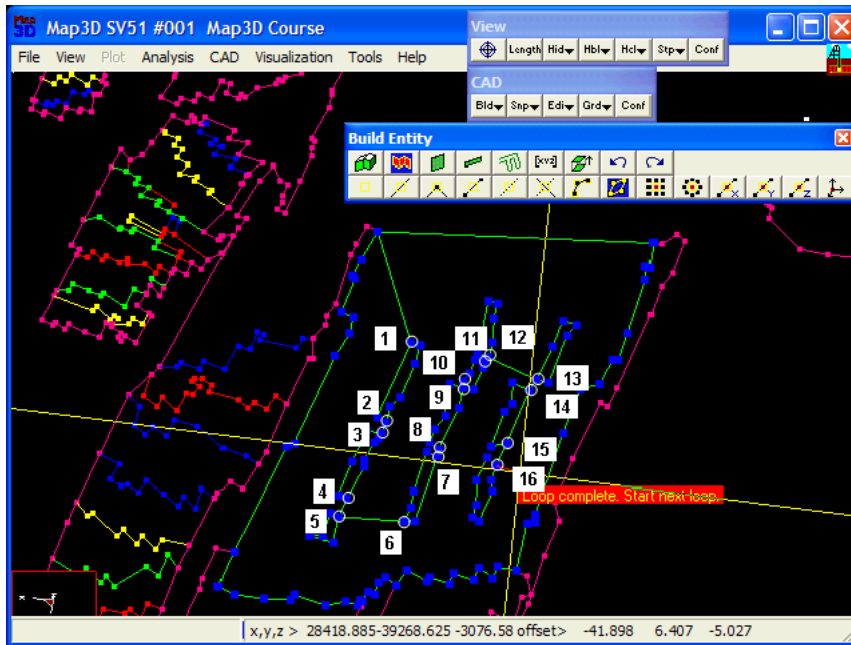

#### Step 5: Signal completion of construction.

- Now that all of the loops have been defined, we pick  ([CAD > Build > DDLoop](#)) again to signal completion of construction.
- This can also be signalled by picking the last point (i.e. point 16) a second time.

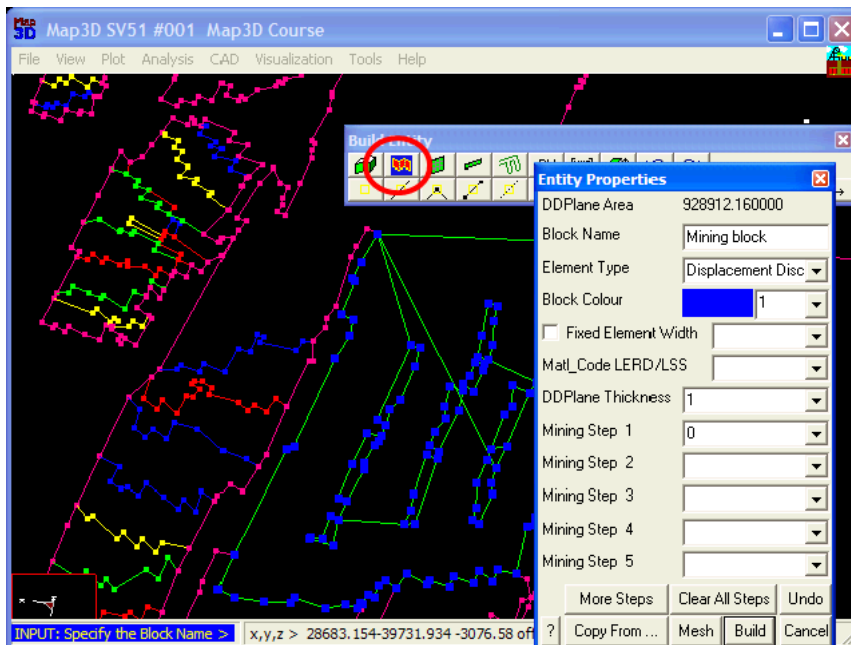

#### Step 6: Build the DDLoops.

- Although we could build the DDLoops using the **Build** function, here we will use the **Mesh** function.
- This later function builds better shaped elements.
- You will be prompted for the desired mesh spacing.
- Set this to 50 metres.

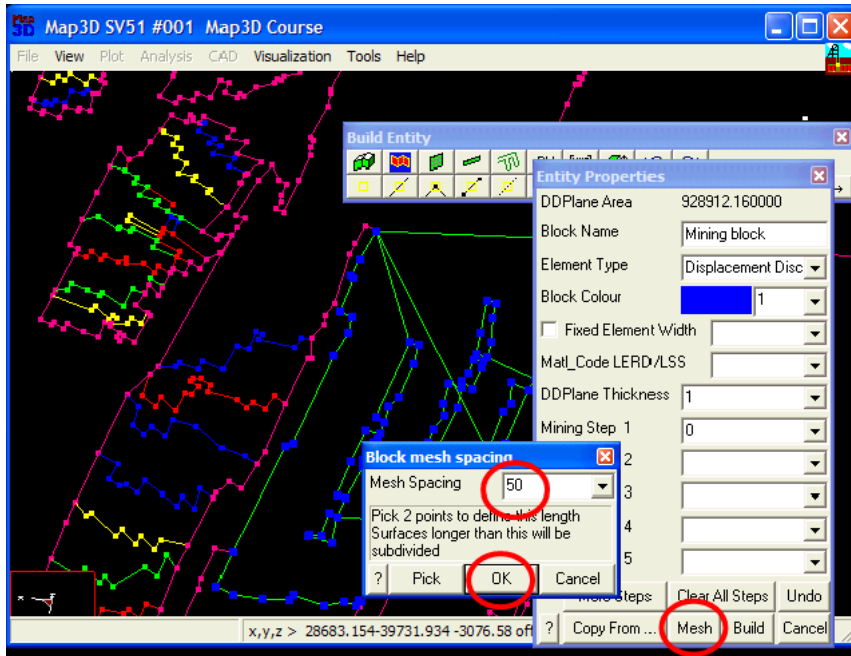

#### Step 7: Construction Complete.

- This completes construction of the tabular mining complete with pillars.
- You will likely want to edit the entity properties of the pillars to assign appropriate properties and mining sequence.

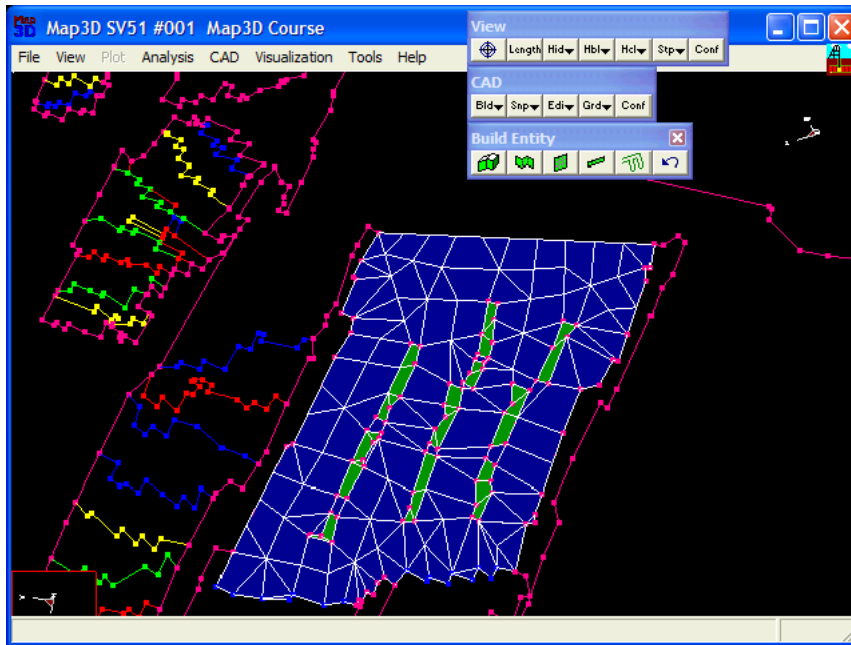



### 3.5 FFLoop Drift Example

Step 1: Import digitized mine plans.

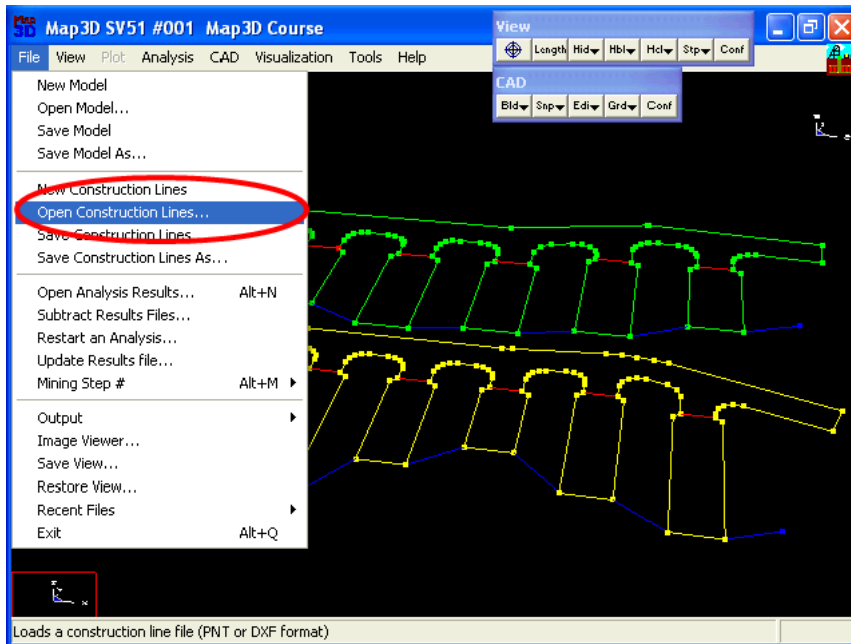
- The plans for this example are in a file called "bulk.dxf".
- These are imported using the [File > Open Construction Lines](#) command.



**Step 2: Next we start the FFLoop routine and set the CLoop snap mode.**

- FFLoop can be started by selecting **Bld** then  (**CAD > Build > FFLoop**).
- CLoop snap mode can be set by selecting  (**CAD > Snap > Trace CLoop**).

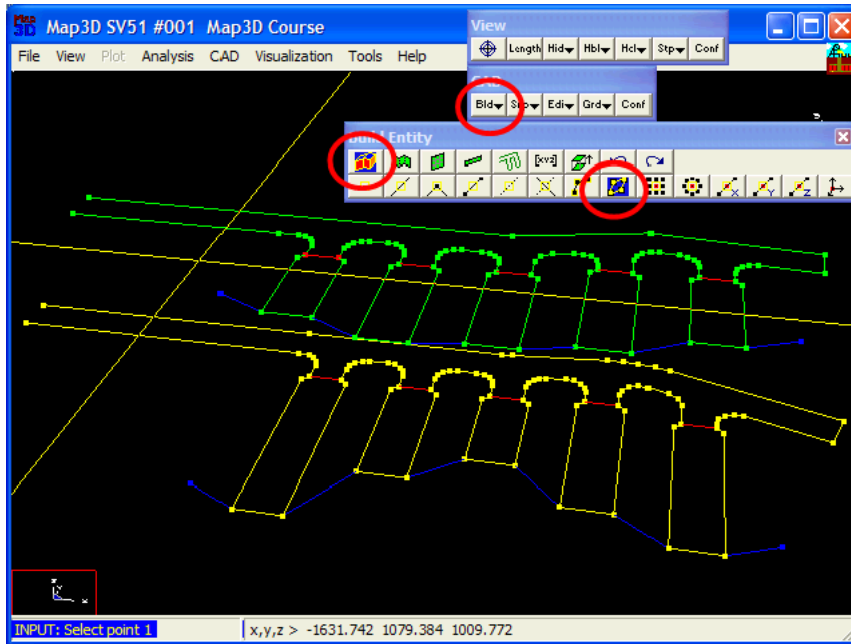

**Step 3: Build the FFLoop.**

- The FFLoop is built by selecting one of the points on the desired construction line.

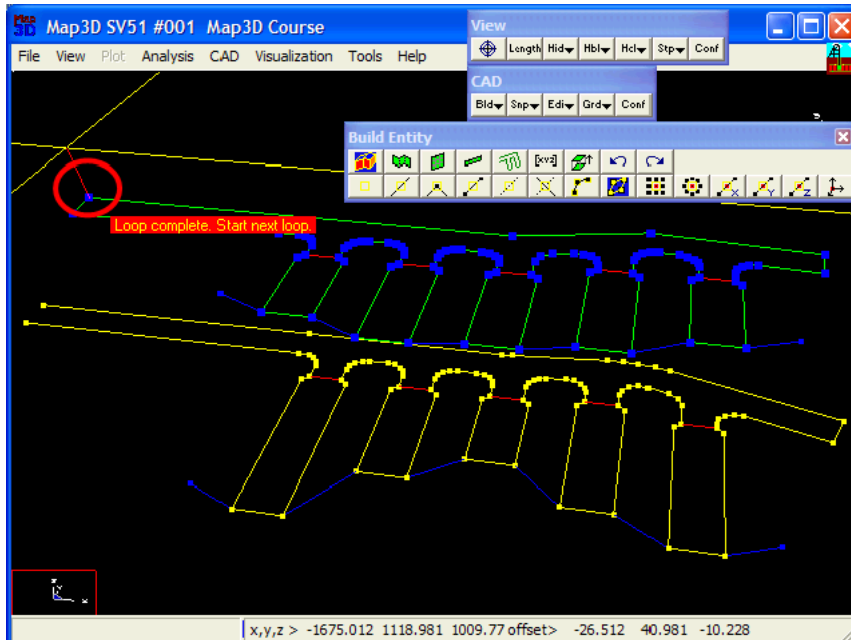

**Step 4: Extrude the floor plan into a 3D drift.**

- At this point we have constructed the floor plan of the drift.
- This can now be extruded into a 3D shape by picking  (CAD > Build > Offset/Extrude).
- Set the offset vector to (0 0 5).

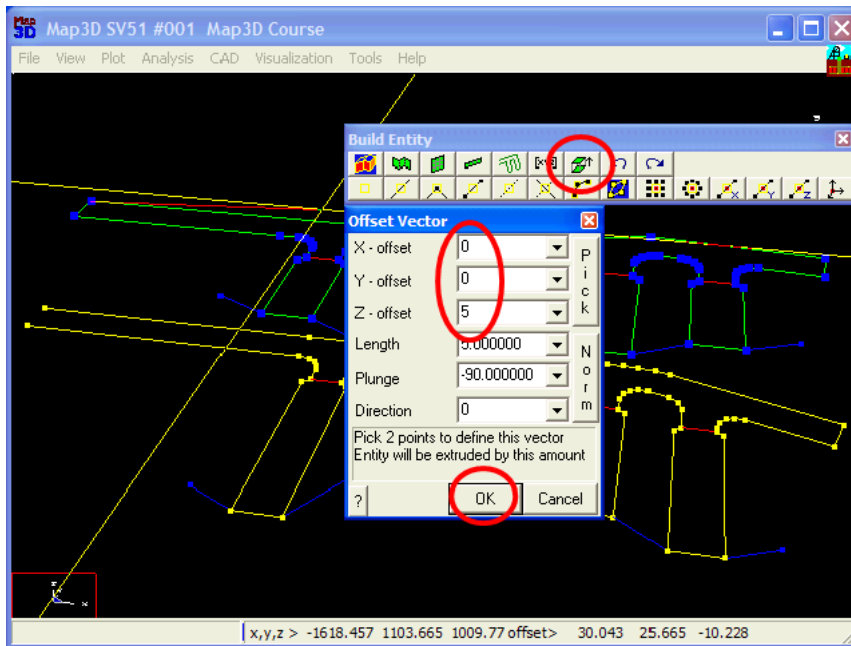
**Step 5: Build the drift.**

- The FFLoop can now be built using the  Mesh function.
- Specify 10 as the Mesh Spacing, then press OK.

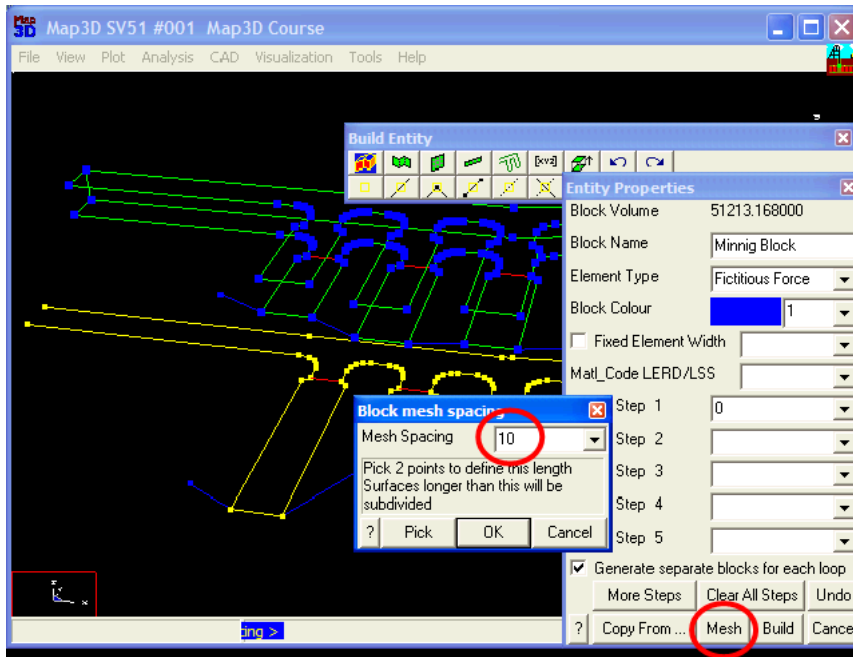

### Step 6: Construction Complete.

- This completes construction of the drift.

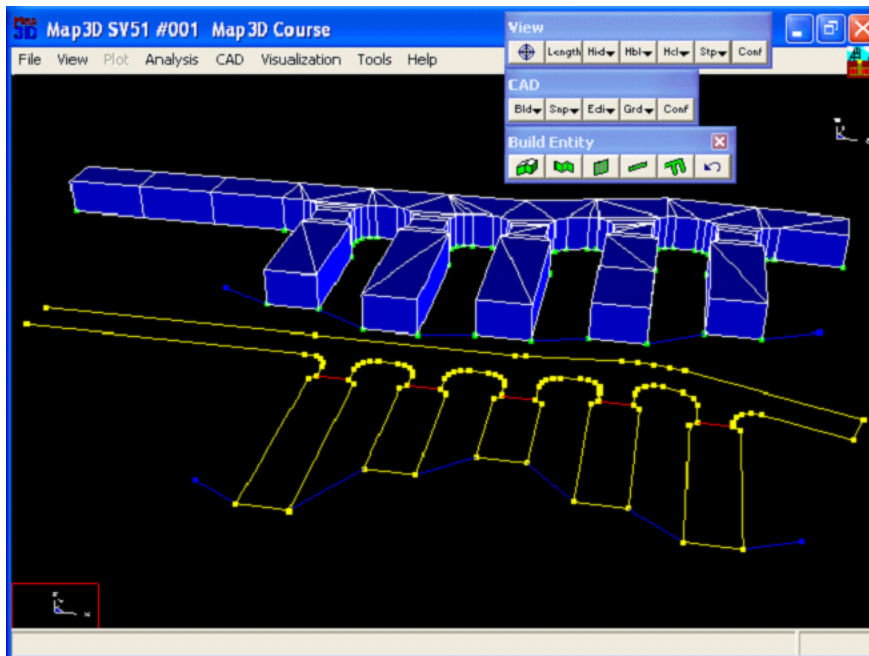





## 3.6 FFLoop Stope Example

### Step 1: Import digitized mine plans.

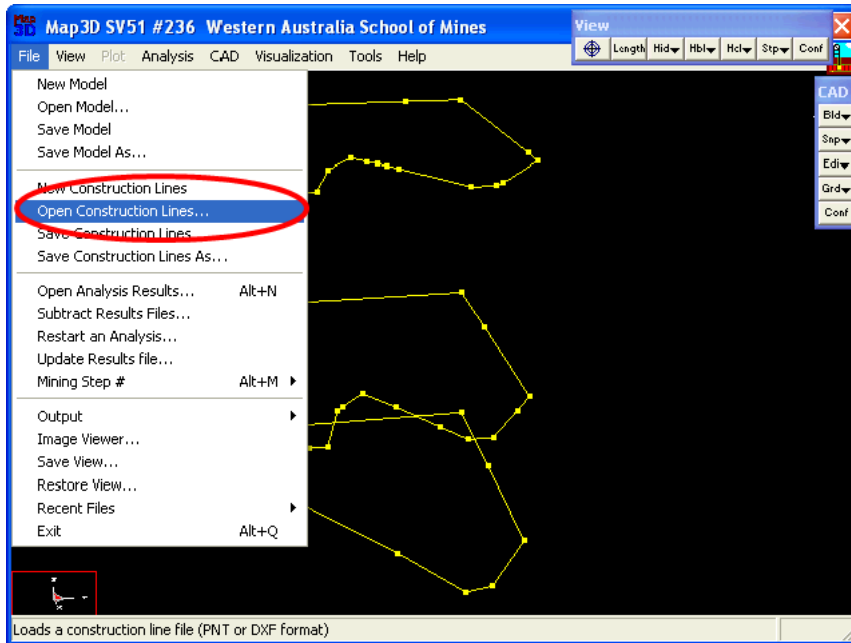
- The plans for this example are in a file called "bulk.dxf".
- These are imported using the [File > Open Construction Lines](#) command.



### Step 2: Next we start the FFLoop routine and set the CLoop snap mode.

- FFLoop can be started by selecting **Blid** then  ([CAD > Build > FFLoop](#)).
- CLoop snap mode can be set by selecting  ([CAD > Snap > Trace CLoop](#)).

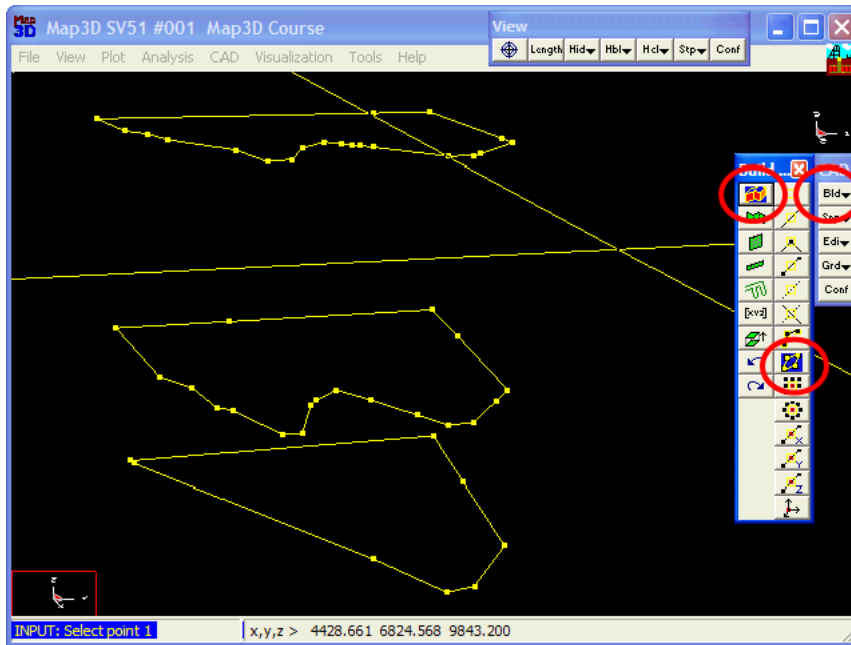

### Step 3: Build the FFLoop.

- The FFLoop is built by selecting one points on each construction line.
- Note that points are automatically be generated at 10m intervals along long sides
- It is best to pick points that are at sharp corners or bends as the line between the loops will guide the construction process.

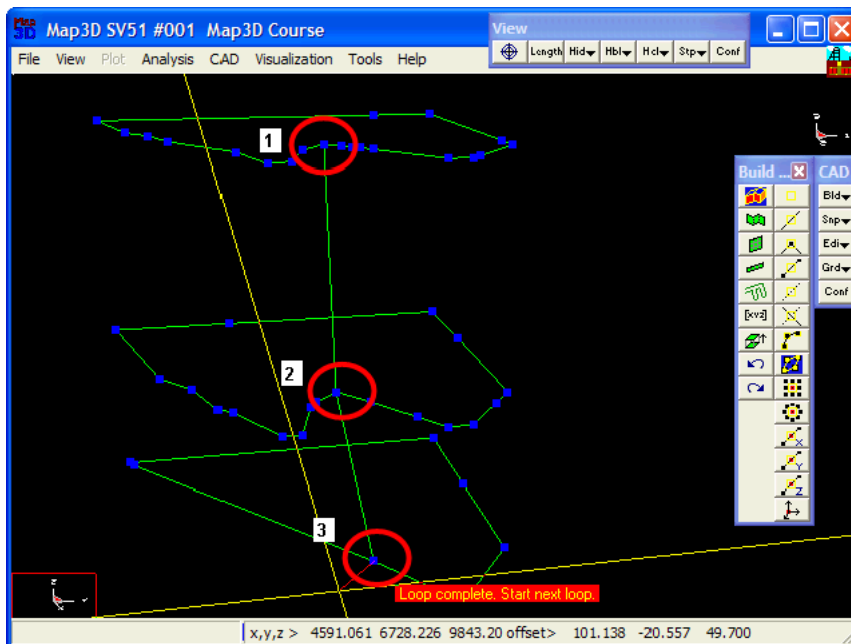

### Step 4: Signal completion of construction.

- Now that all of the loops have been defined, we pick  ([CAD > Build > FFLoop](#)) again to signal completion of construction.
- This can also be signalled by picking the last point (i.e. point 3) a second time.

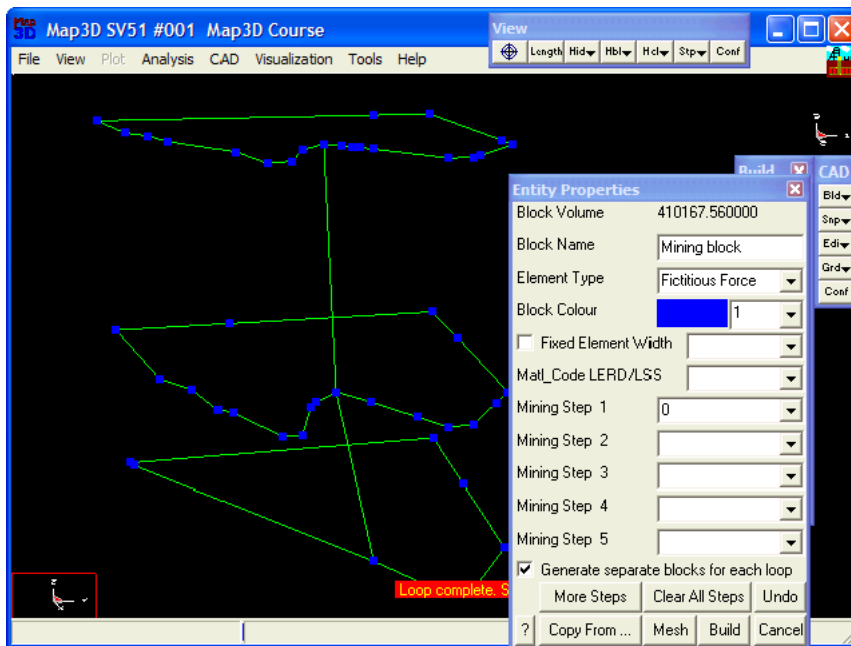

**Step 5: Build the stope.**

- The FFLoop can now be built using the  function.
- Specify 10 for the Mesh Spacing then pick OK.

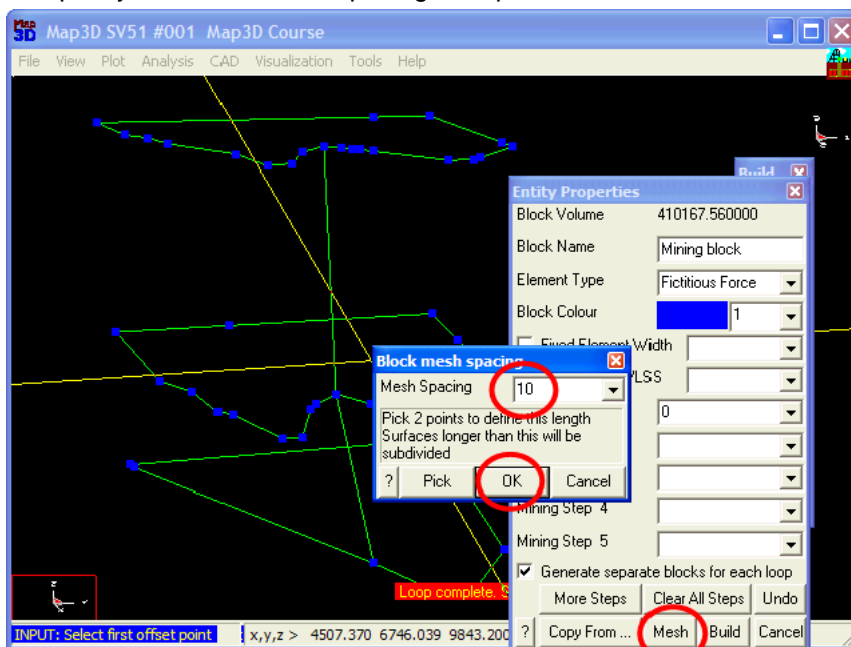

**Step 6: Construction Complete.**

- This completes construction of the slope.

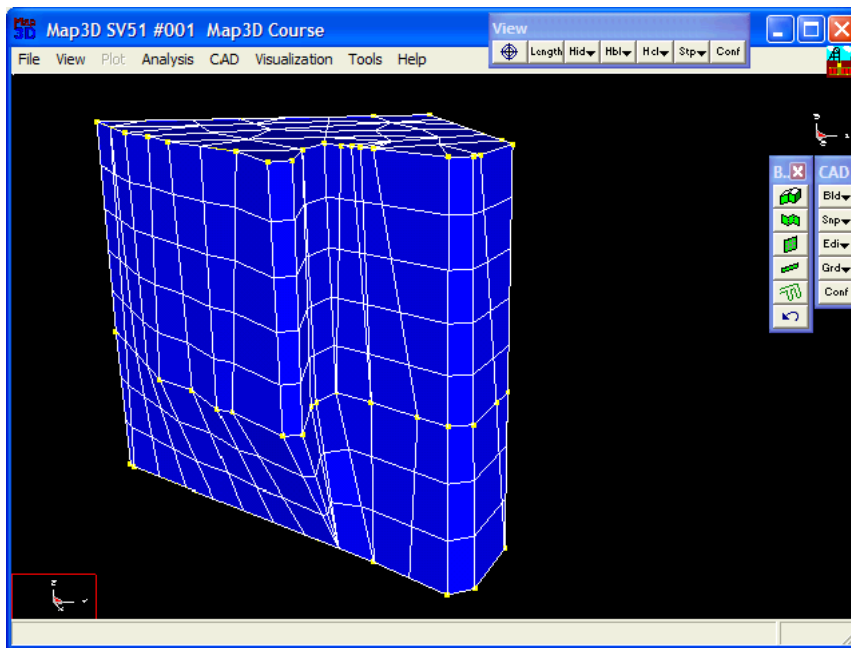

**Map3D  
User's Manual**

**Part**



## 4 Menu Commands

### 4.1 File Menu

#### 4.1.1 New Model (CAD)

Clears all current model data.

All FF blocks, DD planes, field point grids and materials are erased.

#### 4.1.2 Quick Open (View Only)

Quickly loads a model from a file, but skips all preprocessing.

Note that you cannot use any of the CAD functions until you have loaded the file with [Open Model \(CAD\)](#),

or selected "Go To CAD" on the main program menu.

#### Merging multiple files into one model

You may select multiple files simultaneously by holding the standard windows "shift" or "ctrl" keys for multiple selections.

These files will be merging into one model/database.

This allows you to keep separate parts of model data in different files then easily merge them together into one model/database.

Another way of merging multiple files is to select the "Merge Geometries" option prior to selecting the additional file you want to add to the existing model/database.

This is useful if you already have a model open and want to add additional model data to this.

#### 4.1.3 Open Model (CAD)

Loads a model from a file.

Once loaded the user can execute any desired Map3D [Analysis Stage](#).

To add or edit mining blocks and set up the Map3D analysis use

[Analysis > Go to CAD](#).

While loading the model Map3D checks for basic consistency of the modelling parameters (e.g. if a material is used, its properties must be specified in the material list).

You will be prompted to search for a model file name, location and file format. Models can be loaded from several file types:

- [Map3D-INP](#) format is an editable ASCII data file with the extension ".INP". This is the recommended Map3D model format. All Map3D functionality is supported with this format.
- [AutoCAD-DXF](#) format is a popular drawing exchange file with the extension ".DXF". This format is useful for exchanging model data with other CAD software.
- [Point file format](#) is a universal ASCII data file with the extension ".PNT". This format is useful for exchanging raw model data with other CAD software.

The model geometric and material data being loaded can either overwrite or be merged with existing model data. The overwrite/merge options:

- [File > Open > Merge Geometries](#)
- [File > Open > Merge Materials](#)

appears at the bottom of the open file dialogue box.

### Merging multiple files into one model

You may select multiple files simultaneously by holding the standard windows "shift" or "ctrl" keys for multiple selections.

These files will be merging into one model/database.

This allows you to keep separate parts of model data in different files then easily merge them together into one model/database.

Another way of merging multiple files is to select the "Merge Geometries" option prior to selecting the additional file you want to add to the existing model/database.

This is useful if you already have a model open and want to add additional model data to this.

#### Notes:

For quick access at a later session, each time you open a file its name is saved under

[File > Recent Files](#)

and the working directory is saved under

[File > Open > Recent Directories.](#)

To load analysis results use

[File > Open Analysis Results.](#)

To restart an analysis that was aborted or interrupted by a power failure or operating system crash use

[File > Restart an Analysis.](#)

#### 4.1.4 Save Model (CAD)

Saves the current model to a file with its current file name, location, and file format.

To save with a different file name, location or file format use

[File > Save Model As](#)

#### 4.1.5 Save Model As (CAD)

Saves the current model with a different file name, location, and file format.

Models can be saved in several file types:

- [Map3D-INP](#) format is an editable ASCII data file with the extension ".INP". This is the recommended Map3D model format. All Map3D functionality is supported with this format.
- [AutoCAD-DXF](#) format is a popular drawing exchange file with the extension ".DXF". This format is useful for exchanging model data with other CAD software.
- [Point file format](#) is a universal ASCII data file with the extension ".PNT". This format is useful for exchanging raw model data with other CAD software.

To save with the same file name, location or file format use

[File > Save Model](#).

#### 4.1.6 Import model from DXF or PNT

Loads a model from a DXF ([AutoCAD-DXF](#)) or PNT ([Point file format](#)) file.

Once loaded the user can execute any desired Map3D [Analysis Stage](#).

To add or edit mining blocks and set up the Map3D analysis use

[Analysis > Go to CAD](#).

While loading the model Map3D checks for basic consistency of the modelling parameters (e.g. if a material is used, its properties must be specified in the material list).

You will be prompted to search for a model file name, location and file format. Models can be loaded from several file types:

- [AutoCAD-DXF](#) format is a popular drawing exchange file with the extension ".DXF". This format is useful for exchanging model data with other CAD software.
- [Point file format](#) is a universal ASCII data file with the extension ".PNT". This format is useful for exchanging raw model data with other CAD software.

The model geometric and material data being loaded can either overwrite or be merged with existing model data. The overwrite/merge options:

Note that geometric information is imported as [Fictitious Force](#) - FF type elements (used for three-dimensional features such as excavations, alternate material zones, back-filled stopes etc.). If you want to use these as [Displacement Discontinuity](#) - DD type elements (used for tabular mining excavations, fractures and fault planes) you will need to edit these using [CAD > Edit > Entity Properties](#) and change the element type.

- [File > Open > Merge Geometries](#)
- [File > Open > Merge Materials](#)

appears at the bottom of the open file dialogue box.

#### **Merging multiple files into one model**

You may select multiple files simultaneously by holding the standard windows "shift" or "ctrl" keys for multiple selections.

These files will be merging into one model/database.

This allows you to keep separate parts of model data in different files then easily merge them together into one model/database.

Another way of merging multiple files is to select the "Merge Geometries" option prior to selecting the additional file you want to add to the existing model/database.

This is useful if you already have a model open and want to add additional model data to this.

#### **Notes:**

For quick access at a later session, each time you open a file its name is saved under



[File > Recent Files](#)

and the working directory is saved under

[File > Open > Recent Directories.](#)

To load analysis results use

[File > Open Analysis Results.](#)

To restart an analysis that was aborted or interrupted by a power failure or operating system crash use

[File > Restart an Analysis.](#)

#### 4.1.7 Export model as DXF or PNT

Saves the current model with a different file name, location, and file format.

Models can be saved in several file types:

- [AutoCAD-DXF](#) format is a popular drawing exchange file with the extension ".DXF". This format is useful for exchanging model data with other CAD software.
- [Point file format](#) is a universal ASCII data file with the extension ".PNT". This format is useful for exchanging raw model data with other CAD software.

Note that all surfaces in the model will be saved as 3DFACEs.

#### 4.1.8 Restore last CAD State

Restores the last automatically saved CAD State.

During model editing, every time you modify the geometry, the current CAD state is saved to a scratch file that is maintained between Map3D sessions.

This allows to return to exactly where you left off in a new Map3D session, or in the event of program crash.

#### 4.1.9 New Construction Lines

Clears all current construction line data.

#### 4.1.10 Quick Open Construciton Lines (View only)

Quickly loads construction line data from a file, but skips all preprocessing.

Note that you cannot use any of the CAD functions until you have loaded the file with [Open Construction Lines](#),

Construction lines are used to define detailed locations of underground features such as excavations, contacts structure etc. A Map3D model is normally built on top of this construction line data.

You will be prompted to search for a construction line file name, location and file format.

Construction lines can be loaded from several file types:

- [Point file format](#) is a universal ASCII data file with the extension ".PNT". This format is useful for exchanging raw construction line data with other CAD software.

- [AutoCAD-DXF](#) format is a popular drawing exchange file with the extension ".DXF". This format is useful for exchanging construction line data with other CAD software.

The construction line data being loaded can either overwrite or be merged with existing data. The overwrite/merge option

[File > Open > Merge Geometires](#)

appears at the bottom of the open file dialogue box.

### **Merging multiple files into one database**

You may select multiple files simultaneously by holding the standard windows "shift" or "ctrl" keys for multiple selections.

These files will be merging into one database.

This allows you to keep separate parts of construction line data in different files then easily merge them together into one database.

Another way of merging multiple files is to select the "Merge Geometries" option prior to selecting the additional file you want to add to the existing database.

This is useful if you already have construction line data open and want to add additional

#### **4.1.11 Open Construction Lines**

Loads construction lines from a file.

Construction lines are used to define detailed locations of underground features such as excavations, contacts structure etc. A Map3D model is normally built on top of this construction line data.

You will be prompted to search for a construction line file name, location and file format.

Construction lines can be loaded from several file types:

- [Point file format](#) is a universal ASCII data file with the extension ".PNT". This format is useful for exchanging raw construction line data with other CAD software.
- [AutoCAD-DXF](#) format is a popular drawing exchange file with the extension ".DXF". This format is useful for exchanging construction line data with other CAD software.

The construction line data being loaded can either overwrite or be merged with existing data. The overwrite/merge option

[File > Open > Merge Geometires](#)

appears at the bottom of the open file dialogue box.

### **Merging multiple files into one database**

You may select multiple files simultaneously by holding the standard windows "shift" or "ctrl" keys for multiple selections.

These files will be merging into one database.

This allows you to keep separate parts of construction line data in different files then easily merge them together into one database.

Another way of merging multiple files is to select the "Merge Geometries" option prior to selecting the additional file you want to add to the existing database.

This is useful if you already have construction line data open and want to add additional construction

line data to this.

#### 4.1.12 Save Construction Lines

Saves the current construction line data to a file with its current file name, location, and file format.

To save with a different file name, location or file format use [File > Save As](#).

#### 4.1.13 Save Construction Lines As

Saves the current construction lines with a different file name, location, and file format.

Construction lines can be saved in several file types:

- [Point file format](#) is a universal ASCII data file with the extension ".PNT". This format is useful for exchanging raw construction line data with other CAD software.
- [AutoCAD-DXF](#) format is a popular drawing exchange file with the extension ".DXF". This format is useful for exchanging construction line data with other CAD software.

To save with the same file name, location or file format use [File > Save](#).

#### 4.1.14 Open Analysis Results

Loads analysis results from a restart file.

You will be prompted to search for a restart file name, location and [file format](#).

Once loaded, the user can view and process the analysis results. Contour plots of any desired combination of stress, strain and displacement components can be generated. Results can be displayed either as total values, or the difference in value between mining steps.

To change from one mining step to another use

 [File > Mining Step](#).

Notes:

For quick access at a later session, each time you open a file its name is saved under

[File > Recent Files](#)

and the working directory is saved under

[File > Open > Recent Directories](#).

To reload the model file for and editing mining blocks and setting up the Map3D analysis, use

[Analysis > Go to CAD](#).

To load a different model file use

[File > Open \(Model\)](#).

To restart an analysis that was aborted or interrupted by a power failure or operating system crash use

[File > Restart an Analysis](#).

### 4.1.15 Subtract Restart Files

Subtracts results in the selected restart file from the results that are currently loaded.

You will be prompted to search for a restart file name, location and [file format](#).

Notes:

Only results on grid planes are subtracted.

This feature can be used to subtract one mining step from another.

If results from different models are subtracted these models must have identical grid planes.

When subtracting, all Cartesian components (stress, strain and displacement) are subtracted, then principal components of these changes are recalculated for display.

The model geometry for the currently loaded model is retained for display.

### 4.1.16 Restart an Analysis

Restarts an analysis that was aborted or interrupted by a power failure or operating system crash.

This function will scan all mining steps associated with the selected restart file to determine at which mining step the analysis was interrupted. It will then verify that all required scratch files required to restart the analysis are available. Finally it will display this information and offer the option of restarting the analysis from where it left off if this is possible.

In order to restart the following scratch files must be intact:

- file.00n where n is the mining step number where the analysis left off.
- file.1 and file.2 these files are used to restart the solver.
- file.dms this file is only used with the zero strain option ([Analysis > Options > Zero Strain Support Placement](#)).
- file.hms this file is only used by [Map3Di](#) and are used to accumulate the field loading as the analysis progresses.

Notes:

Refer to [Analysis > Options > Initialize](#) to start a new analysis from where a previous model completed.

### 4.1.17 Update Restart Files

Saves modified material strength properties to results files.

After elastic analyses are complete you are free to modify the strength properties since the calculated stresses do not depend on these. This options allows you to save these modified setting to the results file.

## 4.1.18 Mining Step #

Selects a different mining step for viewing.

If the Map3D BEM Analysis for the selected mining step has been completed, the [restart file](#) for this mining step will be loaded. If the restart file does not exist (because the analysis has not been completed) only the geometry for that mining step will be displayed.

Changing between mining steps using this feature is quicker than loading a restart file using

[File > Open Analysis Results](#)

since element and grid sorting do not have to be repeated for the same model.

For quick access to different mining steps use

 [File > Mining Step](#).

from the view toolbar

[Tools > View Toolbar](#).

Individual mining step buttons can be placed on the view toolbar if desired using

[Tools > View Toolbar Configure](#).

You can quickly advance or retard on mining step by holding the Alt key and pressing respectively the + key or – key.

## 4.1.19 Output

### 4.1.19.1 Copy Screen to Clipboard

Dumps a bitmap of the screen to the windows clipboard. This image can be pasted into other applications.

Since normally the screen background is black and element outlines are white, the user may want to select

[File > Output > Copy Screen \(B&W flipped\)](#)

to exchange these two colours.

### 4.1.19.2 Copy Screen (B&W flipped)

Dumps a bitmap of the screen to a PNG (Portable Network Graphics - \*.PNG) , GIF (CompuServe Graphics Interchange Format) or BMP (Windows device independent bitmap \*.BMP) file with the screen background and element outline colours exchanged. This file can be loaded into other software for report presentation and printing.

For more details refer to

[File > Output > PNG, GIF or BMP image](#)

#### 4.1.19.3 PNG, GIF, JPEG, BMP or TIFF Screen Image

Dumps a bitmap of the screen to a PNG (Portable Network Graphics - \*.PNG), GIF (CompuServe Graphics Interchange Format), BMP (Windows device independent bitmap \*.BMP) or TIFF (tagged image file format) file. This file can be loaded into other software for report presentation and printing.

Since normally the screen background is black and element outlines are white, the user may want to select

[File > Output > PNG, GIF, JPEG, BMP or TIFF \(B&W flipped\)](#)

to exchange these two colours.

These files can be displayed using [File > Image Viewer](#)

BMP format is a well supported (most web browsers, word processors and paint programs) graphic file format. The main advantage of BMP format is support for all colours displayed. Unfortunately since there is no compression, these files can be very large (1MB or more each).

PNG format is a well supported (most web browsers, word processors and paint programs) graphic file format. The main advantages of PNG format are excellent lossless compression (normally 1% of the size of a BMP file) and support for all colours displayed. Refer to [File > Output > Image Recorder](#) for animation details.

GIF format is the more widely supported graphic file format. The main advantages of GIF format are excellent lossless compression (normally 1% of the size of a BMP file) and animation capability. Unfortunately GIF only provides support for 256 display colours. Depending on what is displayed, Map3D can use up to 512 colours and hence GIF may not reproduce screen images in all colours

GIF format has been implemented using the specification Version 89a ©1987,1988,1989,1990 Copyright CompuServe Incorporated, Columbus, Ohio.

This software uses the FreeImage open source image library. See <http://freeimage.sourceforge.net> for details. FreeImage is used under the (GNU GPL or FIPL), version (license version).

#### 4.1.19.4 PNG, GIF, JPEG, BMP or TIFF (B&W flipped)

Dumps a bitmap of the screen to a PNG (Portable Network Graphics - \*.PNG) , GIF (CompuServe Graphics Interchange Format) or BMP (Windows device independent bitmap \*.BMP) file with the screen background and element outline colours exchanged. This file can be loaded into other software for report presentation and printing.

For more details refer to

[File > Output > PNG, JPEG, GIF, BMP or TIFF image](#)

#### 4.1.19.5 DXF Screen Image

Dumps a screen image to a file (\*.DXF) in AutoCAD drawing exchange format. This is a vector format that can be imported into many software packages for further rendering.

#### 4.1.19.6 PNT Screen Image

Dumps a screen image to a file (\*.PNT) in a universal ASCII data file with the extension ".PNT". The [PNT format](#) is useful for exchanging raw model data with other CAD software. This is a vector format that can be imported into many software packages for further rendering.

#### 4.1.19.7 OBJ Screen Image

Dumps a screen image to a file (\*.OBJ) in Wavefront format. This is useful for exchanging model data with other CAD and virtual reality modelling software. This is a vector format that can be imported into many software packages for further rendering.

#### 4.1.19.8 WRL Screen Image

Dumps a screen image to a file (\*.WRL) in VRML format. VRML is useful for exchanging model data with other CAD and virtual reality modelling software. This is a vector format that can be imported into many software packages for further rendering.

#### 4.1.19.9 3D-PDF Screen Image

Dumps a screen image to a file in PDF (3D) format.  
3D PDF can be viewed in full 3D with Adobe Reader.

#### 4.1.19.10 Selected Grid Components

Dumps selected grid components to a text file (\*.txt) in a user controlled format.

By default all points on all grids are dumped. If you want to dump only a selected set of points use the window function defined below.

User defined output - Results on Grid Planes

x y z | s1 e1

Stresses

s1 ts1 ps1 s2 ts2 ps2 s3 ts3 ps3  Effective  Induced  
 sxx syy szz sxy syz sxz tmax toct smean  Total  Absolute  
 ti tti pti si tsi psi s1i ts1i ps1i s3i ts3i ps3i  
 tu ttu ptu su tsu psu s1u ts1u ps1u s3u ts3u ps3u

Strains

e1 te1 pe1 e2 te2 pe2 e3 te3 pe3  Elas  Plas  Ind  
 exx eyy ezz exy eyz exz emax eoct evol  Tot  Abs  
 esi tsi pesi eni teni peni e1i te1i pe1i e3i te3i pe3i  
 esu tesu pesu enu tenu penu e1u te1u pe1u e3u te3u pe3u

Displacements

ut tut put ux uy uz  
 uni tuni puni umi tumi

Thermal/Fluid Flow

t qt tqt pqt qx qy qz  
 qni tqni pqni qmi tqmi pqmi  
 qnu tqnu pqnu qmu tqmu pqmu

Miscellaneous

user grid# col# mat# step#  
 name area dgrid dol f1 f2...  Step 0 only  
 Steps 1-0

Data Format

Points  Polylines  Fully populated  Use Commas

? << Cartesian Principal Window Polyline OK Cancel

Upon selecting the desired data then OK, you will be prompted for a file name to save the data. You can select CSV (comma separated/delimited data), TSV (tab separated/delimited data) or TXT (space sepat\rated/delimited data).

You can also specify to automatically open the file in Excel or Notepad. Note that you should not use CSV files with commas as decimal points.

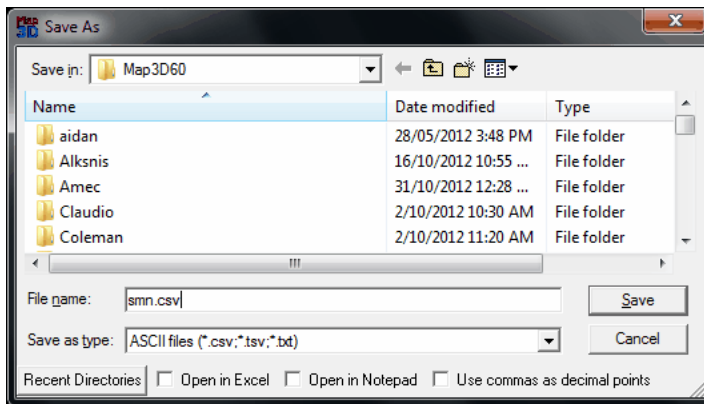

### Stresses:

- [s1 ts1 ps1](#) major principal stress  $\sigma_1$  its trend and plunge.
- [s2 ts2 ps2](#) intermediate principal stress  $\sigma_2$  its trend and plunge.
- [s3 ts3 ps3](#) minor principal stress  $\sigma_3$  its trend and plunge.
- [sxx syy szz sxy syz sxz](#) Cartesian stress components.



[tmax](#) maximum shear stress  $\tau_{\max} = \frac{1}{2} (\sigma_1 - \sigma_3)$

[toct](#) octahedral shear stress  $\tau_{\text{oct}} = \frac{1}{3} [(\sigma_1 - \sigma_2)^2 + (\sigma_2 - \sigma_3)^2 + (\sigma_3 - \sigma_1)^2]^{1/2}$

[smean](#) mean stress  $\sigma_{\text{mean}} = \frac{1}{3} (\sigma_1 + \sigma_2 + \sigma_3)$

[ti tti pti](#) maximum shear stress in the grid plane, its trend and plunge.

[si tsi psi](#) normal stress in the grid plane, its trend and plunge.

[s1i ts1i ps1i](#) maximum stress tangential to the grid plane, its trend and plunge.

[s3i ts3i ps3i](#) minimum stress tangential to the grid plane, its trend and plunge.

[tu ttu ptu](#) maximum shear stress in the ubiquitous-plane, its trend and plunge.

[su tsu psu](#) stress normal to the ubiquitous plane, its trend and plunge.

[s1u ts1u ps1u](#) maximum stress tangential to the ubiquitous plane, its trend and plunge.

[s3u ts3u ps3u](#) minimum stress tangential to the ubiquitous plane, its trend and plunge.

The orientation of the ubiquitous-plane is specified in

 [Plot > Strength Factors > Ubiquitous Parameters](#)

[Effective/Total](#) effective stress or total stress components. These options are only used in [Map3D Thermal-Fluid Flow](#), as this code allows for calculation of steady state pore pressure distributions.

[Induced/Absolute](#) Induced stress is the stress without the pre-mining stress contribution. This represents the stress change since the pre-mining condition. Absolute stress is the stress including the pre-mining stress contribution.

### Strains:

[e1 te1 pe1](#) major principal strain  $\epsilon_1$  its trend and plunge.

[e2 te2 pe2](#) intermediate principal strain  $\epsilon_2$  its trend and plunge.

[e3 te3 pe3](#) minor principal strain  $\epsilon_3$  its trend and plunge.

[exx eyy ezz exy eyz exz](#) Cartesian strain components.

[emax](#) maximum shear strain  $\epsilon_{\max} = \frac{1}{2} (\epsilon_1 - \epsilon_3)$

[eoct](#) octahedral shear strain  $\epsilon_{\text{oct}} = \frac{1}{3} [(\epsilon_1 - \epsilon_2)^2 + (\epsilon_2 - \epsilon_3)^2 + (\epsilon_3 - \epsilon_1)^2]^{1/2}$

[evol](#) volumetric strain  $\epsilon_{\text{vol}} = (\epsilon_1 + \epsilon_2 + \epsilon_3)$

[esi tesi pesi](#) maximum shear strain in the grid plane, its trend and plunge.

[eni teni peni](#) normal strain in the grid plane, its trend and plunge.

[e1i te1i pe1i](#) maximum strain tangential to the grid plane, its trend and plunge.

[e3i te3i pe3i](#) minimum strain tangential to the grid plane, its trend and plunge.

[esu tesu pesu](#) maximum shear strain in the ubiquitous-plane, its trend and plunge.

[enu tenu penu](#) strain normal to the ubiquitous plane, its trend and plunge.

[e1u te1u pe1u](#) maximum strain tangential to the ubiquitous plane, its trend and plunge.

[e3u te3u pe3u](#) minimum strain tangential to the ubiquitous plane, its trend and plunge.

[Elastic/Plastic/Total](#) elastic, plastic or total strain components. These options are only used in [Map3D Non-Linear](#), as this code allows for calculation of non-linear strains.

[Induced/Absolute](#) Induced strain is the strain without the pre-mining contribution. This represents the strain change since the pre-mining condition. Absolute strain is the strain including the pre-mining strain contribution.

### Displacements:

[ut tut put](#) total displacement, its trend and plunge.

[ux uy uz](#) Cartesian displacement components.

[uni tuni puni](#) displacement normal to the grid plane, its trend and plunge.

[umi tumi pumi](#) maximum displacement tangential to the grid plane, its trend and plunge.

[unu tunu punu](#) displacement normal to the ubiquitous plane, its trend and plunge.

[umu tumu pumu](#) maximum displacement tangential to the ubiquitous plane, its trend and plunge.

**Flow:**

[t](#) temperature/head.

[qt tqt pqt](#) total flow, its trend and plunge.

[qx qy qz](#) Cartesian flow components.

[qni tqni pqni](#) displacement normal to the grid plane, its trend and plunge.

[qmi tqmi pqmi](#) maximum displacement tangential to the grid plane, its trend and plunge.

[qnu tqnu pqnu](#) displacement normal to the ubiquitous plane, its trend and plunge.

[qmu tqmu pqmu](#) maximum displacement tangential to the ubiquitous plane, its trend and plunge.

**Miscellaneous:**

[user](#) User defined value.

[grid#](#) the number of the grid where the point is located.

[matl#](#) the number of the material within which the point is located. The host material is material number 1. In problems where multiple materials are used, results may be calculated in an alternate material zone.

[step#](#) the mining step number.

[name](#) the name of the grid.

[area](#) the area of the grid patch adjacent to the point picked.

[dgrid](#) distance to the nearest surface from each grid point.

[dol](#) distance to the nearest grid *Dgrid* divided by the grid spacing *Lgrid*.

[f1 f2...](#) user defined material parameters. These can be defined using [Plot > Properties > Material Properties > User defined Parameters](#).

**Data Format:**

**Points** data will be written out as a series of points with one point per line:

$x_1 y_1 z_1$  values<sub>1</sub>

$x_2 y_2 z_2$  values<sub>2</sub>

$x_3 y_3 z_3$  values<sub>3</sub>

$x_4 y_4 z_4$  values<sub>4</sub>

...

where  $x_i y_i z_i$  represent the coordinates of each point,

values<sub>i</sub> represents the values of the list of user selected components at each point. The user defined values will be listed as a comment line (i.e. a line beginning with an asterisk "\*\*") at the beginning of the file.

**Polylines** data will be written out as a series of polylines in PNT file format

$x_1 y_1 z_1$  3 values<sub>1</sub>

$x_2 y_2 z_2$  2 values<sub>2</sub>

$x_3 y_3 z_3$  2 values<sub>3</sub>

$x_4 y_4 z_4$  2 values<sub>4</sub>

...

where  $x_i y_i z_i$  represent the coordinates of each point,

3 indicates that this point is the beginning of a new line,

2 indicates that this point is a continuation of the same line,

values<sub>i</sub> represents the values of the list of user selected components at each corner of the polyline.

The user defined values will be listed as a comment line (i.e. a line beginning with an asterisk "\*\*") at the beginning of the file.

**Fully Populated** data will be written out such that all data will be on a regular sized grid.

**Use Commas** data will be written out with commas in place of decimal points.

**Other:**

<< to shrink the dialogue box to small size

>> to expand the dialogue box to large size

**Cartesian** configures for output of cartesian stress components.

**Principal** configures for output of principal stress components.

**Window** activates a graphical pick window.

- You will be prompted to select the two corners of the window by picking each with a single mouse click.
- Only grid points enclosed within the window will be included in the dump.
- If you do not use this function all points on all grids are dumped.
- To view the location of the actual contour points enable display of trajectories ([Plot > Options > Trajectories](#)). The contour points are located where the trajectories are drawn.

**Polyline** activates a graphical pick polygon. You will be prompted to select a series of corners to define a polygon by picking each with a single mouse click:

- You must hold the Shift-key down while selecting these points.
- If you define a closed polygonal shape - those contour points enclosed in the polygon will be included.
- If you define an open polygonal shape - a series of points along the length of the polyline will be included.
- To view the location of the actual contour points enable display of trajectories ([Plot > Options > Trajectories](#)). The contour points are located where the trajectories are drawn.
- Simple rectangular window shapes can be defined by holding the Shift-key and dragging open a window (same as with the [Window](#) button).

**4.1.19.11 Selected Surface Components**

Dumps selected surface components to a text file (\*.txt) in a user controlled format.

By default all points on all surfaces are dumped. If you want to dump only a selected set of points use the window function defined below.

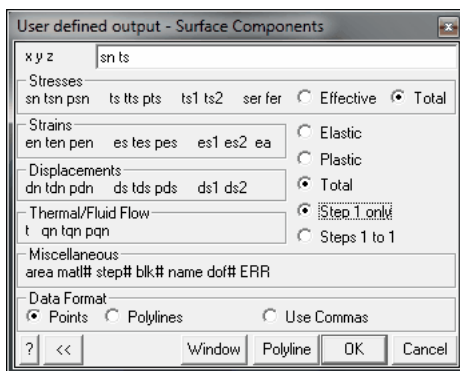

Upon selecting the desired data then OK, you will be prompted for a file name to save the data.

You can select CSV (comma separated/delimited data), TSV (tab separated/delimited data) or TXT (space sepat\rated/delimited data).

You can also specify to automatically open the file in Excel or Notepad.

Note that you should not use CSV files with commas as decimal points.

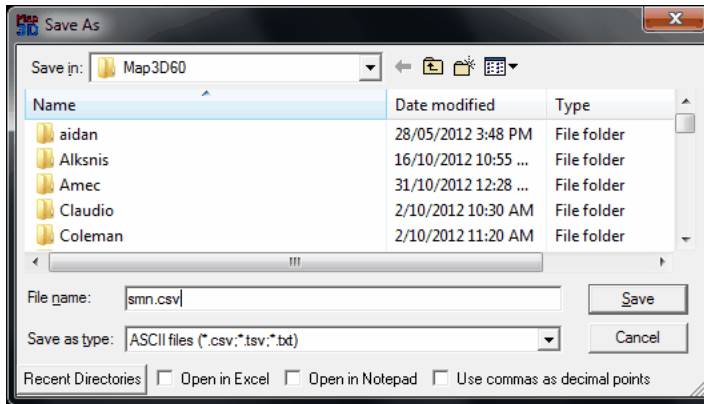

### Stresses:

[sn](#) [tsn](#) [psn](#) stress normal to the surface, its trend and plunge.

[ts](#) [tts](#) [pts](#) maximum shear stress in the plane of the surface, its trend and plunge.

[ts1](#) [ts2](#) shear stress components in the plane of the surface. [ts1](#) is parallel to the first side (i.e. the side defined by  $x_1 y_1 z_1 - x_2 y_2 z_2$ ). [ts2](#) is perpendicular to [ts1](#) in the direction of the second side (i.e. the side defined by  $x_2 y_2 z_2 - x_3 y_3 z_3$ ).

[ser](#) surface stress error. Iterative solvers function by determining the error in the current solution of each simultaneous equation, then reducing these errors by a process of successive approximations. This parameter indicates the error for each of the equations.

[fer](#) failure criterion error. This parameter is only used for non-linear creep analyses (including fault slip and 3D material non-linearity). This parameter should always be near zero unless some viscosity has been specified and the problem goes non-linear. In this latter case, viscous creep can allow stress states above the failure criterion, thus indicating a lack of static equilibrium. This parameter indicates the viscous stress for each of the equations.

[Effective/Total](#) – effective stress or total stress components. These options are only used in [Map3D Thermal-Fluid Flow](#), as this code allows for calculation of steady state pore pressure distributions.

### Strains:

[en](#) [ten](#) [pen](#) strain in the direction normal to the surface, its trend and plunge. This parameter is only used for DD planes and is calculated as the normal displacement (closure) divided by the thickness.

[es](#) [tes](#) [pes](#) maximum shear strain in the plane of the surface, its trend and plunge. This parameter is only used for DD planes and is calculated as the shear displacement (ride) divided by the thickness.

[es1](#) [es2](#) shear strain components in the plane of the surface. [es1](#) is parallel to the first side (i.e. the side defined by  $x_1 y_1 z_1 - x_2 y_2 z_2$ ). [es2](#) is perpendicular to [es1](#) in the direction of the second side (i.e. the side defined by  $x_2 y_2 z_2 - x_3 y_3 z_3$ ).

### Displacements:

[dn](#) [tdn](#) [pdn](#) normal displacement (closure) in the direction normal to the surface, its trend and plunge. This parameter is only used for DD planes. Note that the elastic, plastic or total value can be specified.

[ds](#) [tds](#) [pds](#) maximum shear displacement (ride) in the plane of the surface, its trend and plunge. This parameter is only used for DD planes. Note that the elastic, plastic or total value can be

specified.

**ds1 ds2** shear displacement (ride) components in the plane of the surface. **ds1** is parallel to the first side (i.e. the side defined by  $x_1 y_1 z_1 - x_2 y_2 z_2$ ). **ds2** is perpendicular to ds1 in the direction of the second side (i.e. the side defined by  $x_2 y_2 z_2 - x_3 y_3 z_3$ ).

**Elastic/Plastic/Total** elastic, plastic or total strain/displacement components. These options are only used for DD planes.

### Miscellaneous:

**area** the area of the surface.

**matl#** the number of the material assigned to the surface.

**step#** the mining step number.

**blk#** the block number.

**name** the name of the block surface.

**dof#** the degree of freedom number.

### Data Format

**Points** data will be written out as a series of points with one point per line.

$x_1 y_1 z_1$  values<sub>1</sub>

$x_2 y_2 z_2$  values<sub>2</sub>

$x_3 y_3 z_3$  values<sub>3</sub>

$x_4 y_4 z_4$  values<sub>4</sub>

...

where  $x_i y_i z_i$  represent the coordinates of each point,

**values<sub>i</sub>** represents the values of the list of user selected components at each point. The user defined values will be listed as a comment line (i.e. a line beginning with an asterisk "\*\*") at the beginning of the file.

**Polylines** data will be written out as a series of polylines in PNT file format

$x_1 y_1 z_1$  3 values<sub>1</sub>

$x_2 y_2 z_2$  2 values<sub>2</sub>

$x_3 y_3 z_3$  2 values<sub>3</sub>

$x_4 y_4 z_4$  2 values<sub>4</sub>

...

where  $x_i y_i z_i$  represent the coordinates of each point,

3 indicates that this point is the beginning of a new line,

2 indicates that this point is a continuation of the same line,

**values<sub>i</sub>** represents the values of the list of user selected components at each corner of the polyline.

The user defined values will be listed as a comment line (i.e. a line beginning with an asterisk "\*\*") at the beginning of the file.

If linear BEM analysis ([Analysis > Options > Linear](#)) was not selected, **values<sub>i</sub>** are only available at the element centres and hence will only be supplied for the first point. If linear BEM analysis was selected, values are available at each corner and hence will only be supplied for all points.

### Other

<< to shrink the dialogue box to small size

>> to expand the dialogue box to large size

**Window** activates a graphical pick window.

- You will be prompted to select the two corners of the window by picking each with a single mouse click.

- Only grid points enclosed within the window will be included in the dump.
- If you do not use this function all points on all grids are dumped.
- To view the location of the actual contour points enable display of trajectories ([Plot > Options > Trajectories](#)). The contour points are located where the trajectories are drawn.

**Polyline** activates a graphical pick polygon. You will be prompted to select a series of corners to define a polygon by picking each with a single mouse click:

- You must hold the Shift-key down while selecting these points.
- If you define a closed polygonal shape - those contour points enclosed in the polygon will be included.
- If you define an open polygonal shape - a series of points along the length of the polyline will be included.
- To view the location of the actual contour points enable display of trajectories ([Plot > Options > Trajectories](#)). The contour points are located where the trajectories are drawn.
- Simple rectangular window shapes can be defined by holding the Shift-key and dragging open a window (same as with the [Window](#) button).

**Use Commas** data will be written out with commas in place of decimal points.

#### 4.1.19.12 Animated TIFF/GIF Recorder

Records multiple sequential images to individual PNG, GIF, BMP or TIFF files.

Many presentation programs allow you to construct simple animations by displaying a sequence of images. The Map3D image recorder allows you to record multiple screen dumps to a individual PNG, GIF, BMP or TIFF files.

The animated TIFF/GIF Recorder saves multiple images to the same TIFF or GIF file. These images can be played back with an image viewer that can display animated TIFFs or GIFs (such as [Map3D Image Viewer](#), most internet browsers, Windows Photo Viewer etc.).

The Image Recorder creates multiple images to separate files.

Once you select File > Output > Image Recorder, you will be prompted to specify a file name to save the animation. Image file names will be generated by appending the image count onto the file name you specify (e.g. name0001.png, name0002.png, name0003.png ...).

The recorder dialogue box provides information on the current animation and allows you to control recording and specify animation options.



The current number of images in the animation is displayed along with the status of the recorder. Various status states include:

**Ready/Paused** – animation file is open and ready to record. Press Grab or Auto to add an image.

**Capturing Image** – image is being added to the animation.

**Ready/Auto Capture** - displayed images will be automatically added to the animation as you update the screen.

**Recorder Off** – animation file is closed and not ready to record.

**Grab** – adds the current displayed image to the animation.

**Auto** – automatically adds displayed images to the animation as you update the screen. This includes all rotation, translation and plotting operations you perform.

**Pause** – disables automatic mode.

**End** – stops the recorder and closes the animation file.

**Options** – allows specification of options. Currently the only option is

**Background/foreground flipped** – the background and foreground (normally black and white) will be reversed.

**Notes:**

Additional images can be appended to an existing sequence of images by checking [File > Output > Image Recorder > Append Images](#) when selecting the file name for the animation sequence.

Rotation and translation operations can be repeated automatically by typing n# before selecting the operation. For example to produce an animated display of a stress plot, specify the following

Plot > Options > Persist

Plot > Stress > Sigma:1

View > Rotation Increment > 10

Select the Auto button

Type in 35#

Select rotate right (either from the rotation toolbar or the PageDown key).

A series of files numbered name001 to name036 will be created. These can be imported into presentation software for animation and display.

Stress contours that change as mining progresses can be displayed by grabbing a series of plots as the mining step is advanced.

#### 4.1.20 Image Viewer

Displays PNG (Portable Network Graphics - \*.PNG), GIF (Graphics Interchange Format) or BMP (Windows device independent bitmap \*.BMP) files in a window.

When the viewer is started the current screen image is displayed.

The viewer can be used to display individual images, animated GIFs and sequences of images.

Screen images can be saved to files using

- [File > Output > PNG, GIF or BMP Image](#)
- [File > Output > PNG, GIF or BMP \(B&W flipped\)](#)
- [File > Output > Image Recorder](#)

### 4.1.21 Save View

Save the current view position to a file (\*.VEW). The current orientation and position is saved along with the current contour ranges.

This view can be restored later using

[File > Restore View.](#)

### 4.1.22 Restore View

Restores a previously saved view position from a file (\*.VEW). The orientation and position are restored along with the contour ranges.

The current view can be saved using

[File > Save View.](#)

### 4.1.23 Recent Files

Each time you open a model file its name is saved for quick access at a later session. To reopen one of these files just pick it from the list.

Related Topics:

[File > Open > Recent Directories](#)

### 4.1.24 Exit

Closes the program after prompting you to save any unsaved files.

## 4.2 View Menu

### 4.2.1 Hide

#### 4.2.1.1 Off

These tools are used to make it easy to hide various portions of the geometry.









Selecting the **Hid** button on the View toolbar activates the Hide toolbar











Note that if the **Hid** button is not on the View toolbar it can be added by using the **Conf** button then selecting Hide > Hide More.



-  [View > Hide > Off](#) Turns off the hide function.
-  [View > Hide > Surfaces](#) Hides surfaces by picking one at a time.
-  [View > Hide > Blocks](#) Hides all surfaces that make up the selected block.
-  [View > Hide > Numbers](#) Hide all surfaces with the selected block colour number.
-  [View > Hide > Colour](#) Hide all surfaces with the selected colour.
-  [View > Hide > Materials](#) Hides all surfaces with the selected material number. The same block may have different materials in it depending on the currently active mining step.

When using this later function, make sure to select the appropriate mining step

 [File > Mining Step](#)

-  [View > Hide > Names](#) Hide all surfaces with the selected block name.
-  [View > Hide > Steps](#) Hide all surfaces that are mined in the selected step.
-  [View > Hide > Window](#) Hides all surfaces within the selected window. Entities will only be selected if the entire entity is contained within the window.
-  [View > Hide > Crossing](#) Hides all surfaces within the crossing window. Entities will be selected if even a part of the entity is within the window.
-  [View > Hide > Undo last Hide](#) Undo the last hide operation (maximum of 10 are currently saved).
-  [View > Hide > Redo last Hide](#) Redo the previous hide operation (maximum of 10 are currently saved).
-  [View > Hide > Unhide All](#) Unhide all currently hidden surfaces.
-  [View > Hide > Inactive](#) When activated, inactive elements are displayed. Inactive surfaces are used to display features that are to be included for visualization purposes only and not to be used for the actual stress analysis

 [CAD > Edit > Entity Properties](#)

-  [View > Hide > Solids](#) When activated, solids are hidden. Solids are 3D blocks or DD planes that are not excavated.

As the mining sequence progresses

 [File > Mining Step](#)

different blocks will be excavated. To display only excavations, turn this option on.

-  [View > Hide > Excavations](#) When activated, excavations are hidden.

 [View > Hide > Unused](#) When activated, unused elements are hidden. Unused elements are 3D block surfaces or DD planes that are not used in the analysis. Such elements exist where a fault cuts through an excavation, or where a material with a lower material number resides within a zone with a higher material number (e.g. a dyke cutting through an ore zone).

As the mining sequence progresses

 [File > Mining Step](#)

this may change. To hide unused surfaces, turn this option on. Refer to

[Analysis > Options > Closure](#)  
[Constructing Alternate Material Zones](#)

for additional discussion.

-  [View > Hide > Translucent](#) When activated, hidden surfaces as displayed translucent.

 [View > Hide > Show Errors](#) Hide/display errors (when activated, show only element errors).

Note that this option can be used with the [View > Hide > Translucent](#) option.



[View > Hide > Hide Errors](#) Hide/display errors (when activated, do not show element errors).

At the CAD stage the various colours indicate the following problems:

- Purple - gaps have been found and filled, thus fixing this problem. This message does not indicate an error and is given as user information.
- Green - duplicate blocks have been found and deleted, thus fixing this problem. This message does not indicate an error and is given as user information.
- Blue - narrow gaps have been detected. These gaps do not indicate an error and are not necessarily a problem, however if problems arise during the intersection analysis or BEM analysis, these locations are the most likely causes. This message does not indicate an error and is given as user warning.
- White - edges that link the wrong way have been detected. Closed blocks must have all edges linking in a consistent manner so that the inside and outside of a block can be consistently determined. White edges do not satisfy this requirement. This message does indicate an error which should be fixed before proceeding with the analysis.
- Orange - edges that do not link to other edges have been detected. Closed blocks must have all edges linking to one other edge to form a closed block. Orange edges do not satisfy this requirement. This message does indicate an error which should be fixed before proceeding with the analysis.
- Yellow - edges that link to more than one other edge have been detected. Closed blocks must have all edges linking to only one other edge to form a closed block. Yellow edges do not satisfy this requirement. This message does indicate an error which should be fixed before proceeding with the analysis.
- Red - highlights Visco-Plastic zones with invalid hex shapes. In Map3D Visco-Plastic, plastic zones are only permitted to have hexahedron shapes (4 corners at the top and 4 corners at the bottom) or some degeneration of this shape such as tetrahedron.

At the INTERSECTION stage the various colours indicate the following problems:

- Purple - a surface has been disabled due to an unresolvable contact. When the contacts between various block surfaces was analysed, the way that this surface interfaced with another surface could not be resolved so the surface was disabled and hence will not be used in the BEM stress analysis. The most likely cause of this problem is a very odd shape such as an extremely narrow triangle. Although this is an error, such errors can normally be ignored since extremely narrow shapes contribute little to the analysis results.
- Green - a surface has been disabled due to an unresolvable closure. When the closure of a block was analysed, the way that this surface interfaced with the block could not be resolved so the surface was disabled and hence will not be used in the BEM stress analysis. The most likely cause of this problem is a very odd shape such as an extremely narrow triangle. Although this is an error, such errors can normally be ignored since extremely narrow shapes contribute little to the analysis results.
- Blue - narrow gaps have been detected. These gaps do not indicate an error and are not necessarily a problem, however if problems arise during the intersection analysis or BEM analysis, these locations are the most likely causes. This message does not indicate an error and is given as user warning.
- White - unclosed surfaces have been detected. When the closure of a block was analysed it was found that the interior and exterior of the block could not be consistently determined. This message does indicate an error which should be fixed before proceeding with the analysis.
- Orange - edges that do not link to other edges have been detected. Closed blocks must have all edges linking to one other edge to form a closed block. Orange edges do not satisfy this

requirement. This message does indicate an error which should be fixed before proceeding with the analysis.

- Yellow - a surface has been disabled due to an unresolvable shape. The most likely cause of this problem is a very odd shape such as an extremely narrow triangle. Although this is an error, such errors can normally be ignored since extremely narrow shapes contribute little to the analysis results.

## 4.2.2 Hide Block Colours

### 4.2.2.1 Hide All

This allows you to hide all blocks with the selected colour number.



Selecting the **Hbl** button on the View toolbar activates the Hide Block Colours toolbar.



**Hall** [View > Hide Block Colours > Hide All](#) Hide all block surfaces.

**UHall** [View > Hide Block Colours > Unhide All](#) Unhide all currently hidden surfaces.

The first row hide and un-hides all blocks with the associated colour.

The buttons labelled s1, s2, s3... are used to hide mining steps.

The remaining buttons are labelled with the associated block colour number and are used to hide these. The block name associated with each colour number is displayed in the tooltip and on the menu list.

## 4.2.3 Hide Cline Colours

### 4.2.3.1 Hide All

This allows you to hide all construction lines with the selected colour.



Selecting the **Hcl** button on the View toolbar activates the Hide Cline Colours toolbar.



**Hall** [View > Hide Cline Colours > Hide All](#) Hide all construction lines.

**UHall** [View > Hide Cline Colours > Unhide All](#) Unhide all currently hidden construction lines.

The first row hide and un-hides all clines with the associated colour.

The remaining buttons are labelled with the associated cline colour number and are used to hide these.

## 4.2.4 Hide Grid Colours

### 4.2.4.1 Hide All

This allow you to hides all grids with the selected colour.



Selecting the  button activates the Hide Grid Colours toolbar.



 [View > Hide Grid Colours > Hide All](#) Hide all grids.

 [View > Hide Grid Colours > Unhide All](#) Unhide all currently hidden grids.

The first row hide and un-hides all grids with the associated colour.

The buttons labelled with the associated grid colour number and are used to hide these. The grid name associated with each colour number is displayed in the tooltip and on the menu list.

The remaining buttons are used to hide individual grids just in [Grid Selection](#).

## 4.2.5 Render

### 4.2.5.1 Block Outlines

Sets up rendering options for the model.

[View > Render > Block Outlines](#) - blocks are drawn with outlines showing the edges of the blocks.

[View > Render > Grid Lines](#) - blocks are drawn with lines at regular grid intervals. You are prompted for the grid interval when you activate this feature.

[View > Render > Block Colours](#) - blocks are drawn with colour shading. Turn this feature off for a wireframe view.

[View > Render > Material Numbers](#) - blocks are coloured corresponding to the material property inserted in the block. The same block may have different materials in it depending on the currently active mining step.

When using this function, make sure to select the appropriate mining step

 [File > Mining Step](#)

[View > Render > Mining Step Numbers](#) - blocks are coloured corresponding to the mining step at which they are excavated.

[View > Render > Dark Shading](#) - blocks are drawn with a dark light-source shading model. You are prompted for an edge radius when you activate this feature. The edge radius is used to shade edges and corners to give them a rounded appearance. The edge radius should be specified as a fraction of the block thickness. Shading can considerably slow down the refresh rate.

[View > Render > Bright Shading](#) - blocks are drawn with a bright light-source shading model. You are prompted for an edge radius when you activate this feature. The edge radius is used to shade edges and corners to give them a rounded appearance. The edge radius should be specified as a fraction of the block thickness. Shading can considerably slow down the refresh rate.

[View > Render > Texture Rendering](#) - Toggles texture rendering on/off. Texture rendering allow you to colour surfaces with a bitmap image instead of a solid colour. Refer to [Assign Bock Textures](#)

[View > Render > Block Numbers](#) - blocks are drawn with numbers on their surfaces. These numbers correspond to the currently selected render mode: Block Colours, Material Numbers, or Mining Step Numbers.

[View > Render > Block Names](#) - blocks are drawn with the block names on their surfaces.

[View > Render > Coordinate Numbers](#) - blocks are drawn with the block names on their surfaces.

[View > Render > Backfacing Surfaces](#) - when activated, back-facing surfaces of 3D FF blocks are drawn. Generally the user does not need or want to see these surfaces.

[View > Render > Fixed With Spacing](#) - when activated, surfaces with specified fixed width discretization will be rendered showing the discretization.

[View > Render > Discretize](#) - Toggles the display of discretized and non-discretized views of the model.

[View > Render > Perspective](#) - Toggles the display of perspective or orthogonal viewing. In orthogonal mode, all dimensions are drawn to true scale. In perspective view, entities further from the observer are drawn smaller in size.

[View > Render > Clines Dot Radius](#) - specifies the radius of dots that will be drawn at all corner points along construction lines. This significantly slows the drawing operation and should only be used if needed. A zero value indicates that no dots will be drawn.

[View > Render > Point Size](#) - specifies the radius of dots that will be drawn at all corner points during selection.

[View > Render > Line Width](#) - specifies the width of the block outlines and contour lines.

#### 4.2.5.9 Assign Block Textures

Texture rendering allow you to colour surfaces with a bitmap image instead of a solid colour. To achieve this, do the following:

1. select which colour number you want to assign the texture to (eg. Colour 0, Colour 1 ...)
2. select one of the pre-defined bitmaps, or select your own bitmap using "Image File".
3. In order to map the bitmap image onto each surface you must specify the "Texture Bitmap With". The "Texture Bitmap With" scales the specified bitmap so that the pattern repeated at the geometric width specified.

For example if you specify 1m as the width, then the bitmap will be scaled such that it is drawn with a width of 1m on your block surfaces.

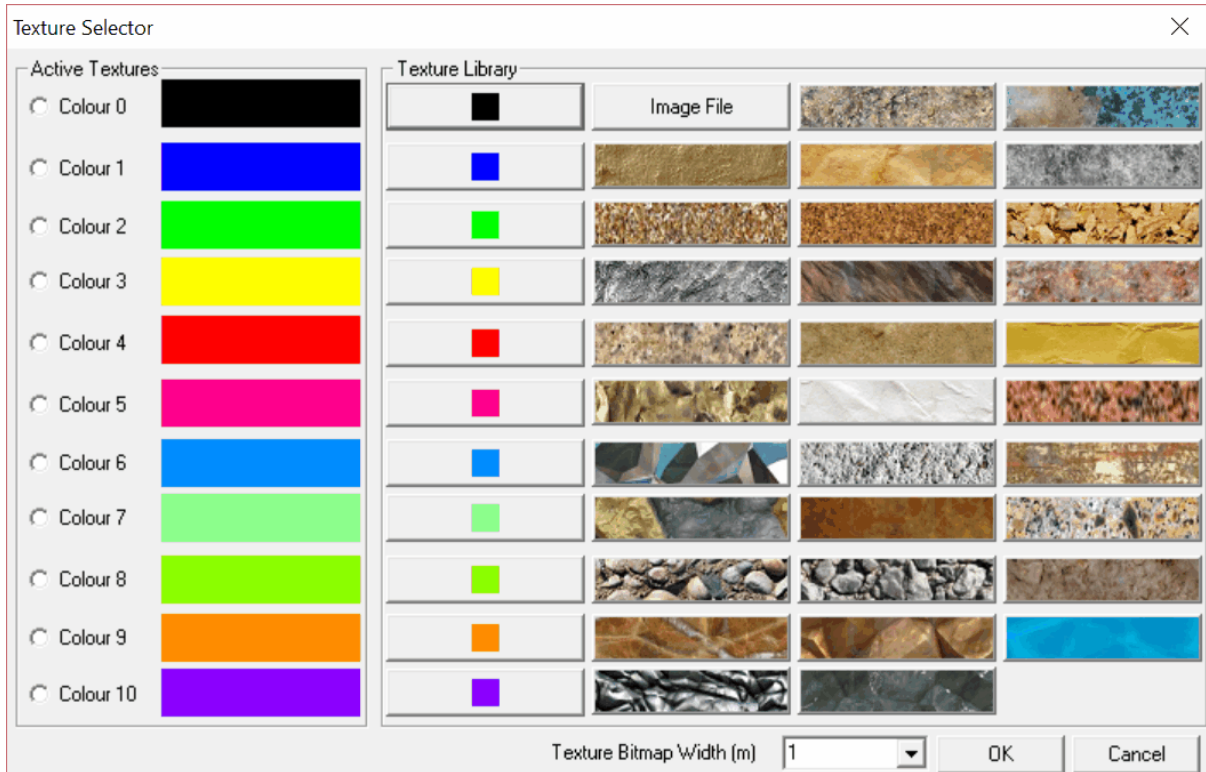

#### 4.2.5.10 Small Block Numbers

Sets up rendering options for the model.

[View > Render > Block Outlines](#) - blocks are drawn with outlines showing the edges of the blocks.

[View > Render > Grid Lines](#) - blocks are drawn with lines at regular grid intervals. You are prompted for the grid interval when you activate this feature.

[View > Render > Block Colours](#) - blocks are drawn with colour shading. Turn this feature off for a wireframe view.

[View > Render > Material Numbers](#) - blocks are coloured corresponding to the material property inserted in the block. The same block may have different materials in it depending on the currently active mining step.

When using this function, make sure to select the appropriate mining step

 [File > Mining Step](#)

[View > Render > Mining Step Numbers](#) - blocks are coloured corresponding to the mining step at which they are excavated.

[View > Render > Dark Shading](#) - blocks are drawn with a dark light-source shading model. You are prompted for an edge radius when you activate this feature. The edge radius is used to shade edges and corners to give them a rounded appearance. The edge radius should be specified as a fraction of the block thickness. Shading can considerably slow down the refresh rate.

[View > Render > Bright Shading](#) - blocks are drawn with a bright light-source shading model. You are prompted for an edge radius when you activate this feature. The edge radius is used to shade edges

and corners to give them a rounded appearance. The edge radius should be specified as a fraction of the block thickness. Shading can considerably slow down the refresh rate.

[View > Render > Texture Rendering](#) - Toggles texture rendering on/off. Texture rendering allow you to colour surfaces with a bitmap image instead of a solid colour. Refer to [Assign Bock Textures](#)

[View > Render > Block Numbers](#) - blocks are drawn with numbers on their surfaces. These numbers correspond to the currently selected render mode: Block Colours, Material Numbers, or Mining Step Numbers.

[View > Render > Block Names](#) - blocks are drawn with the block names on their surfaces.

[View > Render > Coordinate Numbers](#) - blocks are drawn with the block names on their surfaces.

[View > Render > Backfacing Surfaces](#) - when activated, back-facing surfaces of 3D FF blocks are drawn. Generally the user does not need or want to see these surfaces.

[View > Render > Fixed With Spacing](#) - when activated, surfaces with specified fixed width discretization will be rendered showing the discretization.

[View > Render > Discretize](#) - Toggles the display of discretized and non-discretized views of the model.

[View > Render > Perspective](#) - Toggles the display of perspective or orthogonal viewing. In orthogonal mode, all dimensions are drawn to true scale. In perspective view, entities further from the observer are drawn smaller in size.

[View > Render > Clines Dot Radius](#) - specifies the radius of dots that will be drawn at all corner points along construction lines. This significantly slows the drawing operation and should only be used if needed. A zero value indicates that no dots will be drawn.

[View > Render > Point Size](#) - specifies the radius of dots that will be drawn at all corner points during selection.

[View > Render > Line Width](#) - specifies the width of the block outlines and contour lines.

#### 4.2.6 Find Coordinate

Repositions the model so that the display is centred at the specified coordinate. This repositioning is done without rotation or magnification.

#### 4.2.7 Initialize

Initializes all viewing parameters. All contour ranges are also reset.

#### 4.2.8 Zoom Extents

Zoom so that all entities are visible. This repositioning is done without rotation.

## 4.2.9 Zoom

Activates the view toolbar.

The default configuration for this toolbar is as follows



This toolbar provides quick access to various viewing functions.

 [View > Centre of Rotation](#) Sets the centre of rotation. This point remains stationary while you rotate and zoom the display.

 [View > Zoom](#) activates a graphical zoom window. You will be prompted to select the two corners of the window by picking each with a single mouse click.

 [View > Pan](#) activates a graphical pan. You will be prompted to select the two ends of the pan vector by picking each with a single mouse click.

 [View > Length](#) activates a graphical length measuring tool. You will be prompted to select the two ends of the length vector by picking each with a single mouse click. These points must be selected on the model or on a contour. The length, dip and dip direction of the selected vector is reported. If you hold down the shift key while selecting points, you can define a line composed of multiple segments and obtain the total length. If you define a closed polygonal shape (by holding down the shift key while selecting points) on a contour plot, the average contour value within the polygon will be reported (see [Plot > Polygon Box](#)). Simple rectangular window shapes can be defined by holding the shift key and dragging open a window.

 [View > Hide](#) activates the hide toolbar.

 [View > Hide Block Colours](#) activates the hide block colour toolbar.

 [View > Hide CLine Colours](#) activates the hide construction line colour toolbar.

 [File > Mining Step](#) activates the mining step selection toolbar.

 [Tools > View Toolbar Configure](#) adds or removes buttons from the view toolbar.

Notes:

Buttons can be moved around on the toolbar simply by holding down the left mouse button and dragging the button to the desired location.

## 4.2.13 Translation Increment

Sets the translation increment.

This can also be set simply by typing in the desired translation increment then selecting any translate button or key.

Notes:

If the translation toolbar is not visible it can be activated with

[Tools > Translation Toolbar](#).



#### 4.2.14 Rotation Increment

Sets the rotation angle.

This can also be set simply by typing in the desired rotation angle then selecting any rotate button or key.

Notes:

If the rotation toolbar is not visible it can be activated with

[Tools > Rotation Toolbar.](#)

#### 4.2.15 Zoom Factor

Sets the zoom magnification factor.

Each time you zoom in the model will be magnified by this factor. Each time you zoom out the model will be shrunk by this factor.

This can also be set simply by typing in the zoom factor then selecting any zoom button or key.

Notes:

You should set the desired centre of rotation

 [View > Centre of Rotation](#)

before zooming in

 [Zoom In](#)

If the translation toolbar is not visible it can be activated with

[Tools > Translation Toolbar.](#)

#### 4.2.16 View XY plane

Reorients the view of the model to a special view position:

[View > View XY Plane](#) - view with the x-axis to the right and y-axis up.

[View > View YZ Plane](#) - view with the y-axis to the right and z-axis up.

[View > View ZX Plane](#) - view with the x-axis to the right and z-axis up.

[View > View Grid Plane](#) - currently selected grid plane fills the screen

 [CAD > Grid Selection](#)

 [Plot > Grid Selection](#)

[View > View Digitizer Plane](#) current digitizing area fills the screen

[CAD > Digitizer Setup.](#)

Notes:

The current view position can be saved

[File > Save View](#)

or restored

[File > Restore View](#)

between sessions.

#### 4.2.21 View 640x480

Resizes the window to 640x480 pixels to enable standard screen dump size.

#### 4.2.22 Continuous Rotation

Set the model to continuously rotate.

### 4.3 Plot Menu

#### 4.3.1 Stress

##### 4.3.1.1 Major Principal Stress

Contours the principal stresses  $\sigma_1$   $\sigma_2$   $\sigma_3$ .

In elastic analysis, the major principal stress is normally used with the minor principal stress and the Mohr-Coulomb or Hoek-Brown strength criterion









 [Plot > Strength Factors > Strength Parameters](#)

to estimate the amount of damage in the rockmass due to over-stressing. Since none of the parameters have any orientation sensitivity, this criterion is representative for homogeneous rock mass stability.

By contrast, in non-linear analysis the stresses can never exceed the strength unless some creep is used. In this latter case, viscous creep can allow stress states above the failure criterion, thus indicating a lack of static equilibrium. Hence for non-linear analysis one normally directly considers the amount of non-linear strain or the strain rate predicted by the model

[Mohr-Coulomb in 3D FF blocks.](#)

Over-stressing can be presented in several forms including:

		<a href="#">Plot &gt; Strength Factor &gt; SF-A</a>	Strength/Stress
		<a href="#">Plot &gt; Strength Factor &gt; SF-B</a>	Strength/Stress
		<a href="#">Plot &gt; Strength Factors &gt; SF-C</a>	Strength/Stress
		<a href="#">Plot &gt; Strength Factors &gt; dS1</a>	Excess Stress
		<a href="#">Plot &gt; Strength Factors &gt; dTmax</a>	Excess Stress

The contour range is set using

 [Plot > Range](#)

Any of these components can be added to the contouring toolbar if desired

 [Tools > Configure Contouring Toolbar > Stress](#)

The user may find it handy to add the

 [More Stress Components](#)

button to the contouring toolbar for quick access to all stress components.

The intermediate principal stress is normally used in the calculation of the octahedral shear stress

 [Plot > Stress > Toct](#) Octahedral shear Stress

or the mean stress

 [Plot > Stress > Smean](#) Mean Stress.

#### 4.3.1.4 Maximum Shear Stress

Contours the maximum shear stress  $\tau_{max} = \frac{1}{2}(\sigma_1 - \sigma_3)$

In elastic analysis, the maximum shear stress is normally used with the minor principal stress and the Mohr-Coulomb or Hoek-Brown strength criterion





 [Plot > Strength Factors > Strength Parameters](#)

to estimate the amount of damage due to over-stressing. Since none of the parameters have any orientation sensitivity, this criterion is representative for homogeneous rock mass stability.

By contrast, in non-linear analysis the stresses can never exceed the strength unless some creep is used. In this latter case, viscous creep can allow stress states above the failure criterion, thus indicating a lack of static equilibrium. Hence for non-linear analysis one normally directly considers the amount of non-linear strain or the strain rate predicted by the model

[Mohr-Coulomb in 3D FF blocks.](#)

Over-stressing can be presented in several forms including:

 [Plot > Strength Factor > SF-A](#) Strength/Stress  
 [Plot > Strength Factor > SF-B](#) Strength/Stress  
 [Plot > Strength Factors > SF-C](#) Strength/Stress  
 [Plot > Strength Factors > dS1](#) Excess Stress  
 [Plot > Strength Factors > dTmax](#) Excess Stress

The contour range is set using

 [Plot > Range](#)

Any of these components can be added to the contouring toolbar if desired

 [Tools > Configure Contouring Toolbar > Stress](#)

The user may find it handy to add the

 [More Stress Components](#)

button to the contouring toolbar for quick access to all stress components.

#### 4.3.1.5 In-Plane Shear Stress

Contours the maximum shear stress acting on the grid plane, and the stress component normal to the grid plane or parallel to a line grid.

 [Plot > Grid Selection](#)

To calculate the in-plane stresses, the stress state at each point on the grid plane is reoriented to determine the maximum shear stress parallel to the grid plane and the stress normal to the plane. Note that  $\sigma_{ip}$  is oriented normal to the grid plane and parallel to the direction of a line grid.

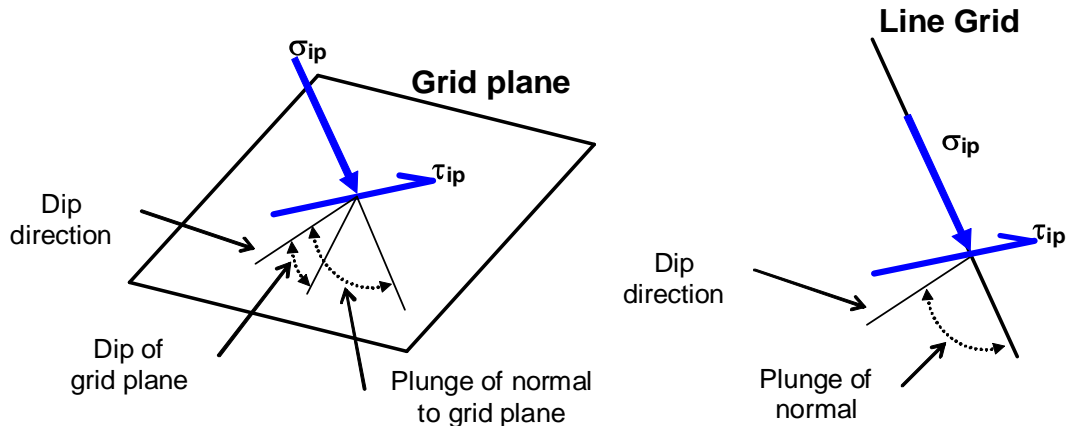

- **dip direction** is measured positive clockwise from the y-axis.
- **dip of the plane** is measured positive down from the horizontal (i.e. the dip direction).
- **plunge of the normal** is measured positive down (i.e. negative up) from the horizontal.

In elastic analysis, the maximum in-plane shear stress is normally used with the in-plane normal stress and the Mohr-Coulomb strength criterion

 [Plot > Strength Factors > In-plane Parameters](#)

to estimate the amount of slip due to over-stressing, on a fault, joint set or bedding plane oriented in the same way as the grid plane. Since these parameters are orientation dependant, this criterion is representative for anisotropic rock mass stability.

By contrast, in non-linear analysis the stresses can never exceed the strength unless some creep is used. In this latter case, viscous creep can allow stress states above the failure criterion, thus indicating a lack of static equilibrium. Hence for non-linear analysis one normally directly considers the amount of non-linear strain or the strain rate predicted by the model

[Mohr-Coulomb in DD planes](#)

[Fault-Gouge in DD planes](#)

[Backfill-Hyperbolic in DD planes.](#)

Over-stressing can be presented in several forms including:

  [Plot > Strength Factors > SF-ip](#) Strength/Stress

 [Plot > Strength Factors > dTP](#) Excess Shear Stress

The contour range is set using

 [Plot > Range](#)

Any of these components can be added to the contouring toolbar if desired





 [Tools > Configure Contouring Toolbar > Stress](#)

The user may find it handy to add the

 [More Stress Components](#)

button to the contouring toolbar for quick access to all stress components.

Related topics:

 [Plot > Stress > S1i](#) In-plane Maximum  
 [Plot > Stress > S3i](#) In-plane Minimum  
 [Plot > Stress > Tub](#) Ubiquitous-plane Shear  
 [Plot > Stress > Sub](#) Ubiquitous-plane Normal

#### 4.3.1.7 In-Plane Maximum Stress

Contours the maximum and minimum stresses tangential to the currently selected grid plane or perpendicular to a line grid.

 [Plot > Grid Selection](#)

To calculate the maximum and minimum in-plane stresses, the stresses tangential to the grid plane are determined, then resolved to give the maximum and minimum values. Note that  $\sigma_{ip}$  is oriented normal to the grid plane and parallel to the direction of a line grid. Also note that  $\sigma_{ip}$ ,  $\sigma_{1i}$  and  $\sigma_{3i}$  are perpendicular to one another.

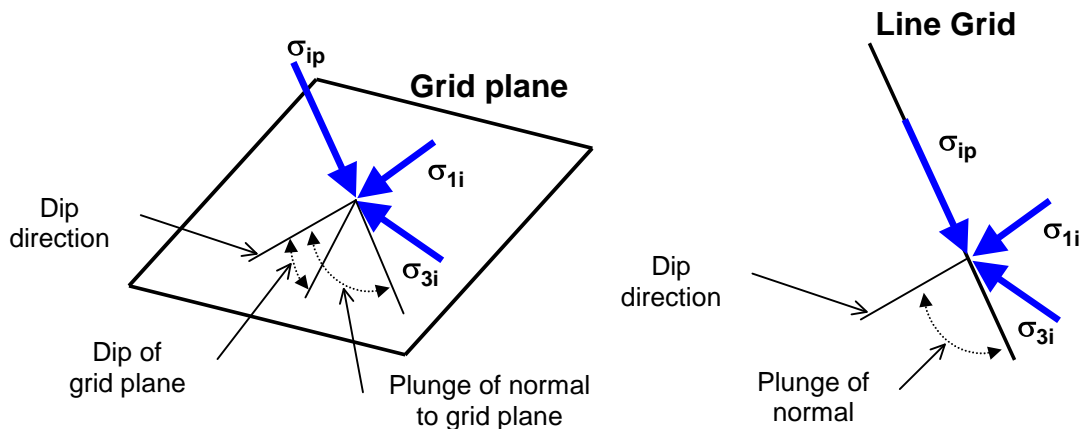

- **dip direction** is measured positive clockwise from the y-axis.
- **dip of the plane** is measured positive down from the horizontal (i.e. the dip direction).
- **plunge of the normal** is measured positive down (i.e. negative up) from the horizontal.

The contour range is set using

 [Plot > Range](#)

This component can be added to the contour toolbar if desired





 [Tools > Configure Contouring Toolbar > Stress](#)

The user may find it handy to add the

 [More Stress Components](#)

button to the contouring toolbar for quick access to all stress components.

Related topics:

	<a href="#">Plot &gt; Stress &gt; Tip</a>	In-plane Shear
	<a href="#">Plot &gt; Stress &gt; Sip</a>	In-plane Normal
	<a href="#">Plot &gt; Stress &gt; S1u</a>	Ubiquitous-plane Maximum.
	<a href="#">Plot &gt; Stress &gt; S3u</a>	Ubiquitous-plane Minimum.

#### 4.3.1.9 Ubiquitous-Plane Shear Stress

Contours the maximum shear stress acting on ubiquitous plane #1, and the stress component normal to this plane.

To calculate the ubiquitous stresses, the stress state at each point on the grid plane is reoriented to determine the maximum shear stress parallel to the ubiquitous plane and the stress normal to the ubiquitous plane. Note that  $\sigma_{ub}$  is oriented normal to the ubiquitous plane and is not parallel to the direction of a line grid.

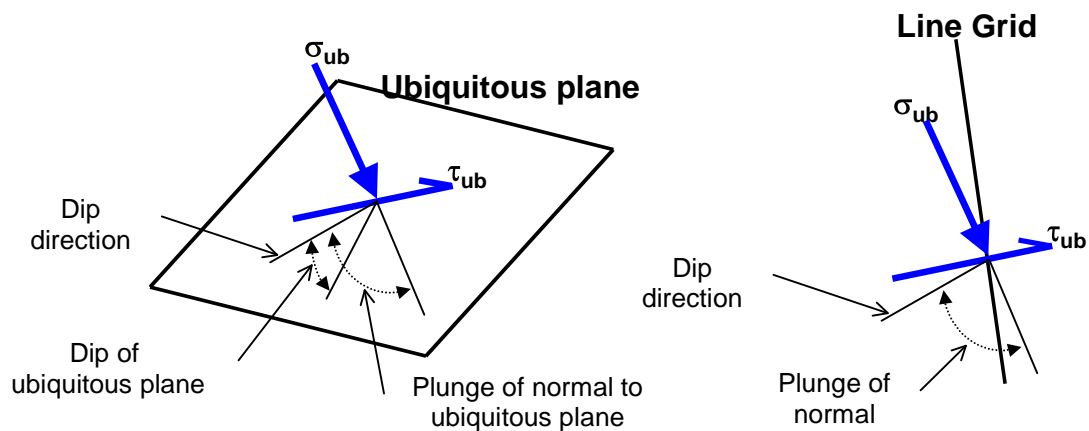

- **dip direction** is measured positive clockwise from the y-axis.
- **dip of the plane** is measured positive down from the horizontal (i.e. the dip direction).
- **plunge of the normal** is measured positive down (i.e. negative up) from the horizontal.

The orientation of the ubiquitous shear plane is set using

 [Plot > Strength Factors > Ubiquitous Parameters](#)

In elastic analysis the maximum ubiquitous-plane shear stress is normally used with the ubiquitous-plane normal stress and the Mohr-Coulomb strength criterion



 [Plot > Strength Factors > Ubiquitous Parameters](#)

to estimate the amount of slip due to over-stressing, on a fault, joint set or bedding plane at the specified orientation. Since these parameters are orientation dependant, this criterion is representative for anisotropic rock mass stability.

By contrast, in non-linear analysis the stresses can never exceed the strength unless some creep is used. In this latter case, viscous creep can allow stress states above the failure criterion, thus indicating a lack of static equilibrium. Hence for non-linear analysis one normally directly considers the amount of non-linear strain or the strain rate predicted by the model

[Mohr-Coulomb in DD planes](#)  
[Fault-Gouge in DD planes](#)  
[Backfill-Hyperbolic in DD planes.](#)

Over-stressing can be presented in several forms including:

 [Plot > Strength Factors > SF-ub](#) Strength/Stress.  
 [Plot > Strength Factors > dTub](#) Excess Shear Stress.

The contour range is set using

 [Plot > Range](#)

This component can be added to the contour toolbar if desired





 [Tools > Configure Contouring Toolbar > Stress](#)

The user may find it handy to add the

 [More Stress Components](#)

button to the contouring toolbar for quick access to all stress components.

Related topics:

 [Plot > Stress > S1u](#) Ubiquitous-plane Maximum  
 [Plot > Stress > S3u](#) Ubiquitous-plane Minimum  
 [Plot > Stress > Tip](#) In-plane Shear  
 [Plot > Stress > Sip](#) In-plane Normal

The orientation of the ubiquitous-plane is specified in

 [Plot > Strength Factors > Ubiquitous Parameters](#)

#### 4.3.1.11 Ubiquitous-Plane Maximum Stress

Contours the maximum and minimum stresses tangential to the ubiquitous plane #1.

To calculate the maximum and minimum ubiquitous-plane stresses, the stresses tangential to the plane are determined, then resolved to give the maximum and minimum values. Note that  $\sigma_{ub}$  is oriented normal to the ubiquitous plane and is not parallel to the direction of a line grid. Also note that  $\sigma_{ub}$ ,  $\sigma_{1u}$  and  $\sigma_{3u}$  are perpendicular to one another.

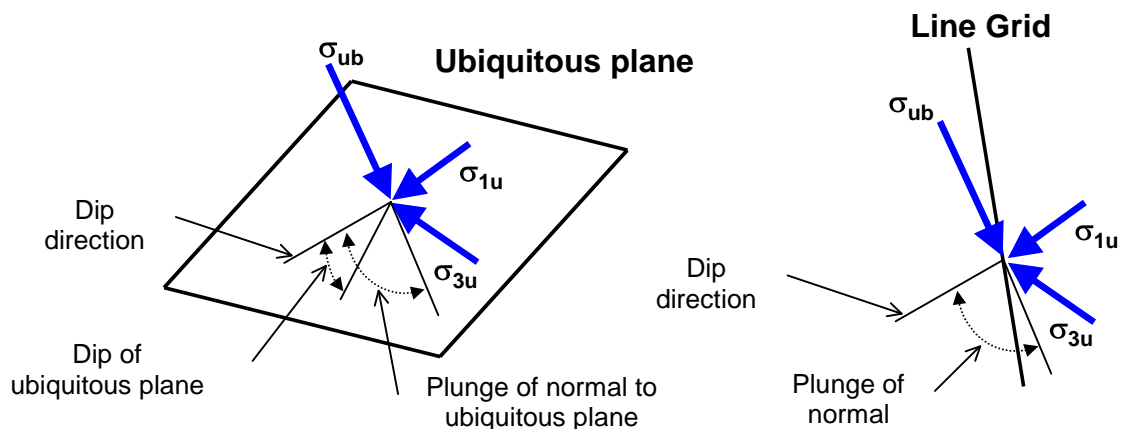

- **dip direction** is measured positive clockwise from the y-axis.
- **dip of the plane** is measured positive down from the horizontal (i.e. the dip direction).
- **plunge of the normal** is measured positive down (i.e. negative up) from the horizontal.

The orientation of the ubiquitous shear plane is set using

 [Plot > Strength Factors > Ubiquitous Parameters](#)

The contour range is set using

 [Plot > Range](#)

This component can be added to the contour toolbar if desired





 [Tools > Configure Contouring Toolbar > Stress](#)

The user may find it handy to add the

 [More Stress Components](#)

button to the contouring toolbar for quick access to all stress components.

Related topics:

 [Plot > Stress > Tub](#) In-plane Shear  
 [Plot > Stress > Sub](#) In-plane Normal  
 [Plot > Stress > S1i](#) In-plane Maximum.  
 [Plot > Stress > S3i](#) In-plane Minimum.

#### 4.3.1.13 Octahedral Shear Stress

Contours the octahedral shear stress

$$\tau_{\text{oct}} = 1/3 [ (\sigma_1 - \sigma_2)^2 + (\sigma_2 - \sigma_3)^2 + (\sigma_3 - \sigma_1)^2 ]^{1/2}$$

and mean stress

$$\sigma_{\text{mean}} = 1/3 (\sigma_1 + \sigma_2 + \sigma_3)$$

In elastic analysis the octahedral shear stress is normally used with the mean stress and the Drucker-Prager strength criterion





 [Plot > Strength Factors > Strength Parameters](#)

to estimate the amount of damage due to over-stressing. Since none of the parameters have any orientation sensitivity, this criterion is representative for homogeneous rock mass stability.

By contrast, in non-linear analysis the stresses can never exceed the strength unless some creep is used. In this latter case, viscous creep can allow stress states above the failure criterion, thus indicating a lack of static equilibrium. Hence for non-linear analysis one normally directly considers the amount of non-linear strain or the strain rate predicted by the model

[Mohr-Coulomb in 3D FF blocks.](#)

Over-stressing can be presented in several forms including:

  [Plot > Strength Factors > SF-C](#) Strength/Stress  
 [Plot > Strength Factors > dToct](#) Excess Stress  
 [Plot > Strength Factors > dS1](#) Excess Stress  
 [Plot > Strength Factors > dTmax](#) Excess Stress



The contour range is set using

 [Plot > Range](#)

Any of these components can be added to the contouring toolbar if desired

 [Tools > Configure Contouring Toolbar > Stress](#)







The user may find it handy to add the

 [More Stress Components](#)

button to the contouring toolbar for quick access to all stress components.

#### 4.3.1.15 Sxx Cartesian Stress

Contours the Cartesian stress components.

	<a href="#">Plot &gt; Stress &gt; <math>\sigma_{xx}</math></a>	Cartesian Stress Component	normal stress in the direction of the x-axis.
	<a href="#">Plot &gt; Stress &gt; <math>\sigma_{yy}</math></a>	Cartesian Stress Component	normal stress in the direction of the y-axis.
	<a href="#">Plot &gt; Stress &gt; <math>\sigma_{zz}</math></a>	Cartesian Stress Component	normal stress in the direction of the z-axis.
	<a href="#">Plot &gt; Stress &gt; <math>\tau_{xy}</math></a>	Cartesian Stress Component	shear stress in the x-y plane.
	<a href="#">Plot &gt; Stress &gt; <math>\tau_{yz}</math></a>	Cartesian Stress Component	shear stress in the y-z plane.
	<a href="#">Plot &gt; Stress &gt; <math>\tau_{zx}</math></a>	Cartesian Stress Component	shear stress in the x-z plane.

The contour range is set using

 [Plot > Range](#)

Any of these components can be added to the contouring toolbar if desired

 [Tools > Configure Contouring Toolbar > Stress](#)

The user may find it handy to add the

 [More Stress Components](#)

button to the contouring toolbar for quick access to all stress components.

#### 4.3.1.21 Value

##### 4.3.1.21.1 Effective stress

Selects the effective or total stress component.

Effective stress is the skeletal stress (i.e. without the pore pressure component).

Total stress is the skeletal stress plus the pore pressure (or thermal component).

This option is only used with [Map3D Thermal-Fluid Flow](#) the Thermal stress/Fluid flow analysis version of Map3D.

Refer to [Expansion Coefficient and Conductivity](#) for details.

## 4.3.1.21.3 Induced Stress

Plot the induced or absolute stress component.

Induced stress is the stress without the pre-mining stress contribution. This represents the stress change since the pre-mining condition.

Absolute stress is the stress including the pre-mining stress contribution.

Also see:

 [Plot > Strain > Value > Induced Strain](#)

 [Plot > Strain > Value > Absolute Strain](#)

## 4.3.2 Strain

### 4.3.2.1 Major Principal Strain

Contours the major, intermediate and minor principal strains.

In elastic analysis the major principal stress is normally used with the minor principal stress and the Mohr-Coulomb or Hoek-Brown strength criterion to estimate the amount of damage due to over-stressing. By contrast, in non-linear analysis the stresses can never exceed the strength unless some creep is used. In this latter case, viscous creep can allow stress states above the failure criterion, thus indicating a lack of static equilibrium. Hence for non-linear analysis one normally directly considers the amount of non-linear strain or the strain rate predicted by the model

[Mohr-Coulomb in 3D FF blocks](#)

Note that there are three components of strain that can be contoured:

 [Plot > Strain > Value > Elastic](#)

 [Plot > Strain > Value > Plastic](#)

 [Plot > Strain > Value > Total](#)

There are also two different ways of presenting the strain:

 [Plot > Strain > Value > Induced Strain](#)

 [Plot > Strain > Value > Absolute Strain](#)

The contour range is set using

 [Plot > Range](#)

Any of these components can be added to the contouring toolbar if desired.

 [Tools > Configure Contouring Toolbar > Strain](#)

The user may find it handy to add the

 [More Strain Components](#)

button to the contouring toolbar for quick access to all strain components.

#### 4.3.2.4 Maximum Shear Strain

Contours the maximum shear strain  $\frac{1}{2}(\epsilon_1 - \epsilon_3)$

In elastic analysis the major principal stress is normally used with the minor principal stress and the Mohr-Coulomb or Hoek-Brown strength criterion to estimate the amount of damage due to over-stressing. By contrast, in non-linear analysis the stresses can never exceed the strength unless some creep is used. In this latter case, viscous creep can allow stress states above the failure criterion, thus indicating a lack of static equilibrium. Hence for non-linear analysis one normally directly considers the amount of non-linear strain or the strain rate predicted by the model

[Mohr-Coulomb in 3D FF blocks](#)

Note that there are three components of strain that can be contoured:

 [Plot > Strain > Value > Elastic](#)

 [Plot > Strain > Value > Plastic](#)

 [Plot > Strain > Value > Total](#)

There are also two different ways of presenting the strain:

 [Plot > Strain > Value > Induced Strain](#)

 [Plot > Strain > Value > Absolute Strain](#)

The contour range is set using

 [Plot > Range](#)

Any of these components can be added to the contouring toolbar if desired

 [Tools > Configure Contouring Toolbar > Strain](#)

The user may find it handy to add the

 [More Strain Components](#)

button to the contouring toolbar for quick access to all strain components.

#### 4.3.2.5 In-Plane Shear Strain

Contours the maximum shear strain acting on the grid plane, and the strain component normal to the grid plane or parallel to a line grid.

 [Plot > Grid Selection](#)

To calculate the in-plane strains, the strain state at each point on the grid plane is reoriented to determine the maximum shear strain parallel to the grid plane and the strain normal to the plane. Note that  $\epsilon_{ip}$  is oriented normal to the grid plane and parallel to the direction of a line grid.

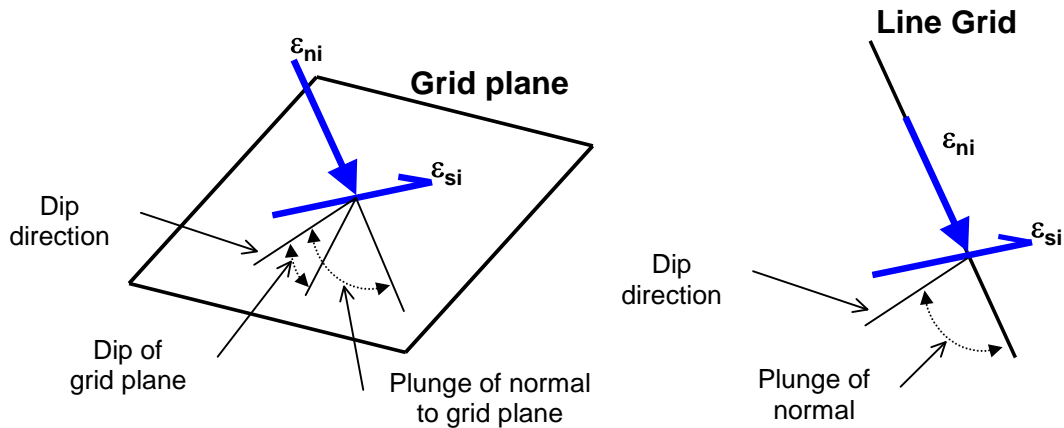

- **dip direction** is measured positive clockwise from the y-axis.
- **dip of the plane** is measured positive down from the horizontal (i.e. the dip direction).
- **plunge of the normal** is measured positive down (i.e. negative up) from the horizontal.

In elastic analysis the maximum in-plane shear stress is normally used with the in-plane normal stress and the Mohr-Coulomb strength criterion

#### [Mohr-Coulomb in 3D FF blocks](#)

to estimate the amount of damage due to over-stressing. By contrast, in non-linear analysis the stresses can never exceed the strength unless some creep is used. In this latter case, viscous creep can allow stress states above the failure criterion, thus indicating a lack of static equilibrium. Hence for non-linear analysis one normally directly considers the amount of non-linear strain or the strain rate predicted by the model

#### [Mohr-Coulomb in DD planes](#)

to estimate the amount of slip due to over-stressing, on a fault, joint set or bedding plane oriented in the same way as the grid plane. Since these parameters are orientation dependant, this criterion is representative for anisotropic rock mass stability.

Note that there are three components of strain that can be contoured:

- $\epsilon^{el}$  [Plot > Strain > Value > Elastic](#)
- $\epsilon^{pl}$  [Plot > Strain > Value > Plastic](#)
- $\epsilon^{tot}$  [Plot > Strain > Value > Total](#)

There are also two different ways of presenting the strain:

- $\epsilon^{ind}$  [Plot > Strain > Value > Induced Strain](#)
- $\epsilon^{abs}$  [Plot > Strain > Value > Absolute Strain](#)

The contour range is set using

- $\text{Range}$  [Plot > Range](#)

Any of these components can be added to the contouring toolbar if desired





- $\text{Conf}$  [Tools > Configure Contouring Toolbar > Strain](#)

The user may find it handy to add the

 [More Strain Components](#)

button to the contouring toolbar for quick access to all strain components.

Related topics:

-  [Plot > Strain > e1i](#) In-plane Maximum
-  [Plot > Strain > e3i](#) In-plane Minimum
-  [Plot > Strain > esu](#) Ubiquitous-plane Shear
-  [Plot > Strain > enu](#) Ubiquitous-plane Normal

#### 4.3.2.7 In-Plane Maximum Strain

Contours the maximum and minimum strains tangential to the currently selected grid plane or perpendicular to a line grid.

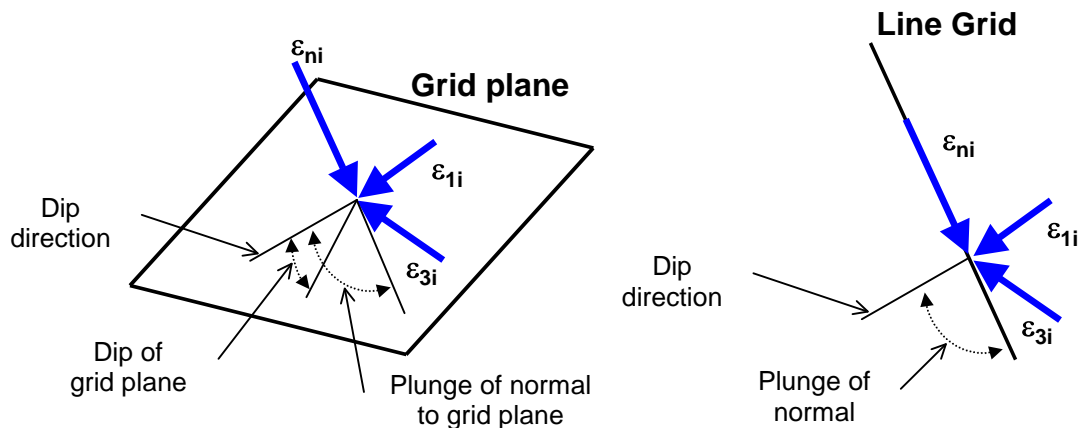

 [Plot > Grid Selection](#)

To calculate the maximum and minimum in-plane strains, the strains tangential to the grid plane are determined, then resolved to give the maximum and minimum values. Note that  $\epsilon_{ni}$  is oriented normal to the grid plane and parallel to the direction of a line grid. Also note that  $\epsilon_{ni}$ ,  $\epsilon_{1i}$  and  $\epsilon_{3i}$  are perpendicular to one another.





- **dip direction** is measured positive clockwise from the y-axis.
- **dip of the plane** is measured positive down from the horizontal (i.e. the dip direction).
- **plunge of the normal** is measured positive down (i.e. negative up) from the horizontal.

Note that there are three components of strain that can be contoured:

-  [Plot > Strain > Value > Elastic](#)
-  [Plot > Strain > Value > Plastic](#)
-  [Plot > Strain > Value > Total](#)

There are also two different ways of presenting the strain:

-  [Plot > Strain > Value > Induced Strain](#)
-  [Plot > Strain > Value > Absolute Strain](#)

The contour range is set using

-  [Plot > Range](#)

This component can be added to the contour toolbar if desired

 [Tools > Configure Contouring Toolbar > Strain](#)

The user may find it handy to add the

 [More Strain Components](#)

button to the contouring toolbar for quick access to all strain components.

Related topics:

 [Plot > Strain > esi](#) In-plane Shear

 [Plot > Strain > eni](#) In-plane Normal

 [Plot > Strain > e1u](#) Ubiquitous-plane Maximum.

 [Plot > Strain > e3u](#) Ubiquitous-plane Minimum.

#### 4.3.2.9 Ubiquitous-Plane Shear Strain

Contours the maximum shear strain acting on ubiquitous plane #1, and the strain component normal to this plane.

To calculate the ubiquitous strains, the strain state at each point on the grid plane is reoriented to determine the maximum shear strain parallel to the ubiquitous plane and the strain normal to the ubiquitous plane. Note that  $\epsilon_{nu}$  is oriented normal to the ubiquitous plane and is not parallel to the direction of a line grid.

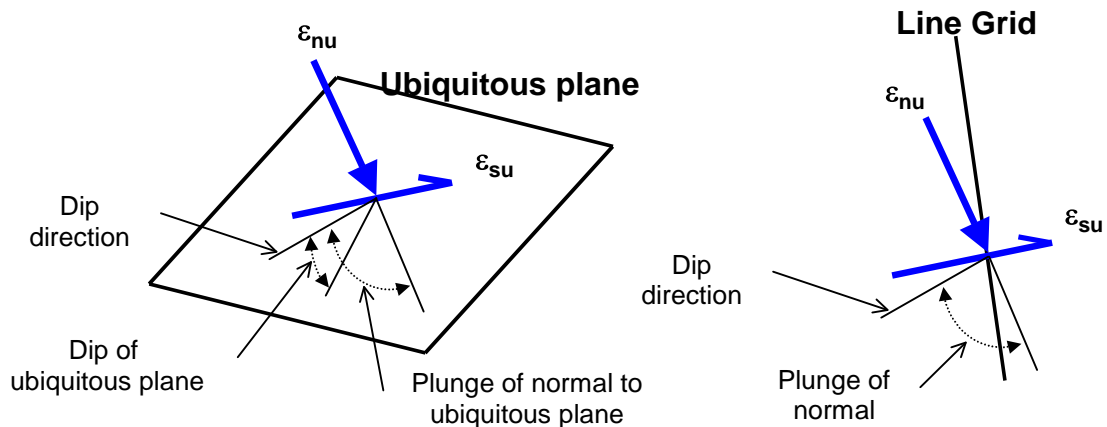



- **dip direction** is measured positive clockwise from the y-axis.
- **dip of the plane** is measured positive down from the horizontal (i.e. the dip direction).
- **plunge of the normal** is measured positive down (i.e. negative up) from the horizontal.

The orientation of the ubiquitous shear plane is set using

 [Plot > Strength Factors > Ubiquitous Parameters](#)

Note that there are three components of strain that can be contoured:

 [Plot > Strain > Value > Elastic](#)

 [Plot > Strain > Value > Plastic](#)

 [Plot > Strain > Value > Total](#)

There are also two different ways of presenting the strain:

 [Plot > Strain > Value > Induced Strain](#)

 [Plot > Strain > Value > Absolute Strain](#)

The contour range is set using

 [Plot > Range](#)

This component can be added to the contour toolbar if desired

 [Tools > Configure Contouring Toolbar > Strain](#)

The user may find it handy to add the

 [More Strain Components](#)

button to the contouring toolbar for quick access to all strain components.

Related topics:

 [Plot > Strain > e1u](#) Ubiquitous-plane Maximum.

 [Plot > Strain > e3u](#) Ubiquitous-plane Minimum.

 [Plot > Strain > esi](#) In-plane Shear

 [Plot > Strain > eni](#) In-plane Normal

#### 4.3.2.11 Ubiquitous-Plane Maximum Strain

Contours the maximum and minimum strains tangential to the ubiquitous plane #1.

To calculate the ubiquitous strains, the strain state at each point on the grid plane is reoriented to determine the maximum and minimum strain parallel to the ubiquitous plane. Note that  $\epsilon_{nu}$  is not oriented normal to the ubiquitous plane and is not parallel to the direction of a line grid.

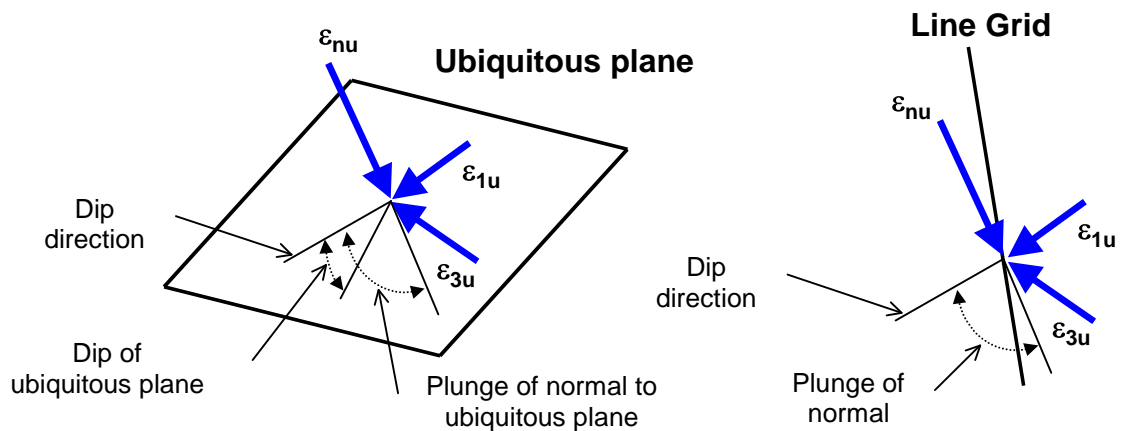

- [dip direction](#) is measured positive clockwise from the y-axis.
- [dip of the plane](#) is measured positive down from the horizontal (i.e. the dip direction).
- [plunge of the normal](#) is measured positive down (i.e. negative up) from the horizontal.

The orientation of the ubiquitous shear plane is set using

 [Plot > Strength Factors > Ubiquitous Parameters](#)

Note that there are three components of strain that can be contoured:

 [Plot > Strain > Value > Elastic](#)

 [Plot > Strain > Value > Plastic](#)

 [Plot > Strain > Value > Total](#)

There are also two different ways of presenting the strain:

 [Plot > Strain > Value > Induced Strain](#)

 [Plot > Strain > Value > Absolute Strain](#)

The contour range is set using

 [Plot > Range](#)

This component can be added to the contour toolbar if desired

 [Tools > Configure Contouring Toolbar > Strain](#)

The user may find it handy to add the

 [More Strain Components](#)

button to the contouring toolbar for quick access to all strain components.

Related topics:

 [Plot > Strain > esi](#) Ubiquitous-plane Shear

 [Plot > Strain > eni](#) Ubiquitous-plane Normal

 [Plot > Strain > e1u](#) In-plane Maximum.

 [Plot > Strain > e3u](#) In-plane Minimum.

#### 4.3.2.13 Octahedral Shear Strain

Contours the octahedral shear strain

$$\varepsilon_{\text{oct}} = 1/3 [ (\varepsilon_1 - \varepsilon_2)^2 + (\varepsilon_2 - \varepsilon_3)^2 + (\varepsilon_3 - \varepsilon_1)^2 ]^{1/2}$$

and the volumetric strain

$$\varepsilon_{\text{vol}} = (\varepsilon_1 + \varepsilon_2 + \varepsilon_3)$$

In elastic analysis the major principal stress is normally used with the minor principal stress and the Mohr-Coulomb or Hoek-Brown strength criterion to estimate the amount of damage due to over-stressing.

By contrast, in non-linear analysis the stresses can never exceed the strength unless some creep is used. In this latter case, viscous creep can allow stress states above the failure criterion, thus indicating a lack of static equilibrium. Hence for non-linear analysis one normally directly considers the amount of non-linear strain or the strain rate predicted by the model

[Mohr-Coulomb in 3D FF blocks](#)

Note that there are three components of strain that can be contoured:

 [Plot > Strain > Value > Elastic](#)

 [Plot > Strain > Value > Plastic](#)

 [Plot > Strain > Value > Total](#)



There are also two different ways of presenting the strain:

 [Plot > Strain > Value > Induced Strain](#)

 [Plot > Strain > Value > Absolute Strain](#)

The contour range is set using

 [Plot > Range](#)

This component can be added to the contour toolbar if desired

 [Tools > Configure Contouring Toolbar > Strain](#)

The user may find it handy to add the

 [More Strain Components](#)

button to the contouring toolbar for quick access to all strain components.

#### 4.3.2.15 Exx Strain Component

Contours the Cartesian stress components.

 [Plot > Strain >  \$\epsilon\_{xx}\$](#)  Cartesian Strain Component normal strain in the direction of the x-axis

 [Plot > Strain >  \$\epsilon\_{yy}\$](#)  Cartesian Strain Component normal strain in the direction of the y-axis

 [Plot > Strain >  \$\epsilon\_{zz}\$](#)  Cartesian Strain Component normal strain in the direction of the z-axis

 [Plot > Strain >  \$\epsilon\_{xy}\$](#)  Cartesian Strain Component normal strain in the direction of the x-y plane

 [Plot > Strain >  \$\epsilon\_{yz}\$](#)  Cartesian Strain Component normal strain in the direction of the y-z plane

 [Plot > Strain >  \$\epsilon\_{xz}\$](#)  Cartesian Strain Component normal strain in the direction of the x-z plane

Note that there are three components of strain that can be contoured:

 [Plot > Strain > Value > Elastic](#)

 [Plot > Strain > Value > Plastic](#)

 [Plot > Strain > Value > Total](#)

There are also two different ways of presenting the strain:

 [Plot > Strain > Value > Induced Strain](#)

 [Plot > Strain > Value > Absolute Strain](#)

The contour range is set using

 [Plot > Range](#)

This component can be added to the contour toolbar if desired

 [Tools > Configure Contouring Toolbar > Strain](#)

The user may find it handy to add the

 [More Strain Components](#)

button to the contouring toolbar for quick access to all strain components.

### 4.3.2.21 Value

#### 4.3.2.21.1 Elastic strain

Selects the elastic, plastic or total strain component.

For details, refer to

[Mohr-Coulomb in 3D FF blocks.](#)

#### 4.3.2.21.4 Induced Strain

Plot the induced or absolute strain component.

Induced strain is the strain without the pre-mining strain contribution. This represents the strain change since the pre-mining condition.

Absolute strain is the strain including the pre-mining strain contribution.

Also see:

 [Plot > Stress > Value > Induced Strain](#)

 [Plot > Stress > Value > Absolute Strain](#)

#### 4.3.2.21.6 Strain

Plot strain:

- in unscaled units (strain/1),
- in milli-strain (strain/1000),
- in micro-strain (strain/1000000).

## 4.3.3 Displacement

### 4.3.3.1 Total displacement

Activate the displacement toolbar – after Map3D BEM analysis.



This toolbar is meant to provide quick access to displacement components.

 [Plot > Displacement >  \$\delta\_{total} = \(\delta\_x^2 + \delta\_y^2 + \delta\_z^2\)^{1/2}\$](#)  Total Displacement contours the total displacement

 [Plot > Displacement >  \$\delta\_x\$](#)  X-Displacement contours the x-displacement component

 [Plot > Displacement >  \$\delta\_y\$](#)  Y-Displacement contours the y-displacement component

 [Plot > Displacement >  \$\delta\_z\$](#)  Z-Displacement contours the z-displacement component

To calculate the in-plane displacements, the displacement state at each point on the grid plane is reoriented to determine the maximum displacement parallel to the grid plane and the displacement normal to the plane. Note that  $\delta_{ni}$  is oriented normal to the grid plane and parallel to the direction of a line grid.

**$\delta_{ni}$**  Plot > Displacement >  $\delta_{ni}$  In-plane normal contours the displacement component normal to the grid plane.

**$\delta_{mi}$**  Plot > Displacement >  $\delta_{mi}$  In-plane maximum contours the maximum displacement tangential to the grid plane.

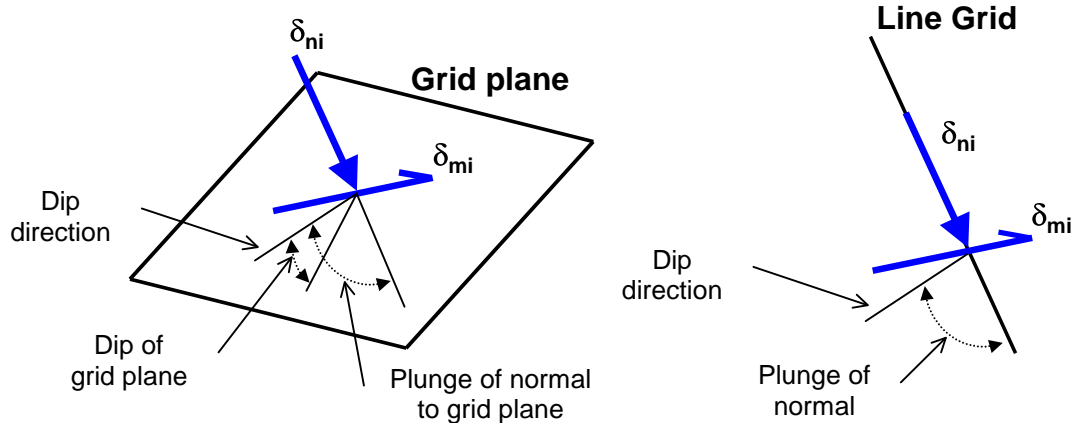

To calculate the ubiquitous-plane #1 displacements, the displacement state at each point on the grid plane is reoriented to determine the maximum displacement parallel to the ubiquitous plane #1 and the displacement normal to the plane. Note that  $\delta_{mi}$  is not oriented normal to the grid plane.

**$\delta_{nu}$**  Plot > Displacement >  $\delta_{nu}$  Ubiquitous-plane normal contours the displacement component normal to the ubiquitous plane.

**$\delta_{mu}$**  Plot > Displacement >  $\delta_{mu}$  Ubiquitous-plane maximum contours the maximum displacement tangential to the ubiquitous plane.

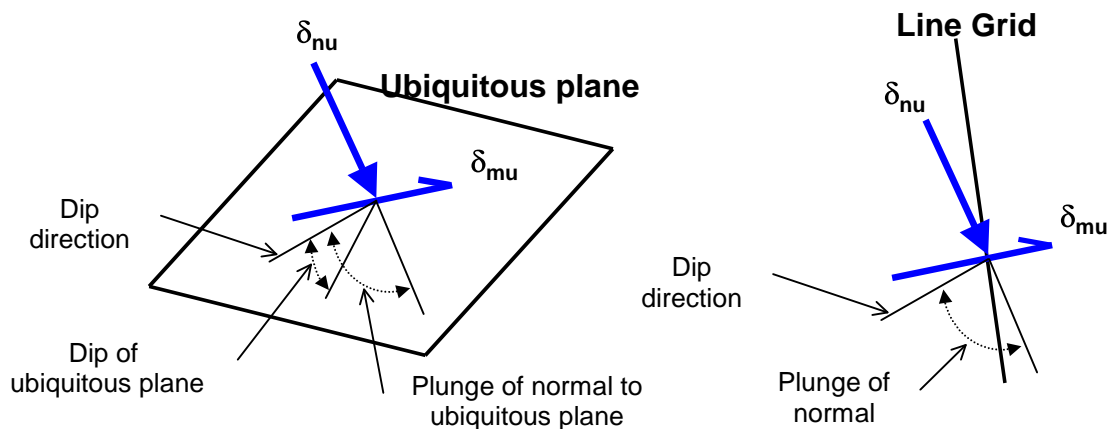

- **dip direction** is measured positive clockwise from the y-axis.
- **dip of the plane** is measured positive down from the horizontal (i.e. the dip direction).
- **plunge of the normal** is measured positive down (i.e. negative up) from the horizontal.

Notes:

The displacement toolbar can only be activated after the model building - CAD Stage

### [Map3D Analysis Stages.](#)

The orientation of the ubiquitous shear plane is set using

 [Plot > Strength Factors > Ubiquitous Parameters](#)

The contour range is set using

 [Plot > Range](#)

This component can be added to the contour toolbar if desired

 [Tools > Configure Contouring Toolbar > Displacement](#)

The user may find it handy to add the

 [More Displacement Components](#)

button to the contouring toolbar for quick access to all displacement components.

## 4.3.4 User defined plot

Contours a user defined stress component.

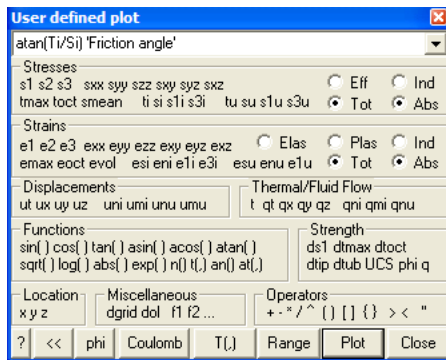

### Stresses:

- [S1 S2 S3](#) principal stress components  $\sigma_1 \sigma_2 \sigma_3$
- [Sxx Syy Szz Sxy Syz Sxz](#) Cartesian stress components  $\sigma_{xx} \sigma_{yy} \sigma_{zz} \tau_{xy} \tau_{yz} \tau_{zx}$
- [Tmax](#) maximum shear stress  $\frac{1}{2}(\sigma_1 - \sigma_3)$
- [Toct](#) octahedral shear stress  $\tau_{oct} = \frac{1}{3} [(\sigma_1 - \sigma_2)^2 + (\sigma_2 - \sigma_3)^2 + (\sigma_3 - \sigma_1)^2]^{\frac{1}{2}}$
- [Smean](#) mean stress  $\sigma_{mean} = \frac{1}{3} (\sigma_1 + \sigma_2 + \sigma_3)$
- [Ti Si](#) maximum shear and normal stress in the grid plane  $\tau_{ip} \sigma_{ip}$
- [S1i S3i](#) maximum and minimum stress tangential to the grid plane  $\sigma_{1i} \sigma_{3i}$
- [Tu Su](#) maximum shear and normal stress in the ubiquitous-plane  $\tau_{ub} \sigma_{ub}$ . The orientation of the ubiquitous shear plane is set using   
 [Plot > Strength Factors > Ubiquitous Parameters](#)
- [S1u S3u](#) maximum and minimum stress tangential to the ubiquitous plane  $\sigma_{1u} \sigma_{3u}$
- [Effective/Total](#) effective stress or total stress components. These options are only used in

[Map3D Thermal-Fluid Flow](#), as this code allows for calculation of steady state pore pressure distributions.

- [Induced/Absolute](#) induced stress or absolute stress components (i.e. the stress without the pre-mining stress contribution).

### Strains:

- [e1 e2 e3](#) major principal strain  $\varepsilon_1 \varepsilon_2 \varepsilon_3$
- [exx eyy ezz exy eyz exz](#) Cartesian strain components  $\varepsilon_{xx} \varepsilon_{yy} \varepsilon_{zz} \varepsilon_{xy} \varepsilon_{yz} \varepsilon_{zx}$
- [emax](#) maximum shear strain  $\frac{1}{2}(\varepsilon_1 - \varepsilon_3)$
- [eoct](#) octahedral shear strain  $\varepsilon_{oct} = \frac{1}{3} [(\varepsilon_1 - \varepsilon_2)^2 + (\varepsilon_2 - \varepsilon_3)^2 + (\varepsilon_3 - \varepsilon_1)^2]^{\frac{1}{2}}$
- [evol](#) volumetric strain  $\varepsilon_{vol} = (\varepsilon_1 + \varepsilon_2 + \varepsilon_3)$
- [esi eni](#) maximum shear and normal strain in the grid plane  $\varepsilon_{si} \varepsilon_{ni}$
- [e1i e3i](#) maximum and minimum strain tangential to the grid plane  $\varepsilon_{1i} \varepsilon_{3i}$
- [esu enu](#) maximum shear and normal strain in the ubiquitous-plane  $\varepsilon_{su} \varepsilon_{nu}$
- [e1u e3u](#) maximum and minimum strain tangential to the ubiquitous plane  $\varepsilon_{1u} \varepsilon_{3u}$
- [Elastic/Plastic/Total](#) elastic, plastic or total strain components. These options are only used in [Map3D Non-Linear](#), as this code allows for calculation of non-linear strains.
- [Induced/Absolute](#) induced strain or absolute strain components (i.e. the stress without the pre-mining stress contribution).

### Displacements:

- [ut](#) total displacement, its trend and plunge  $\delta_t$
- [ux uy uz](#) Cartesian displacement components  $\delta_x \delta_y \delta_z$
- [uni](#) displacement normal to the grid plane  $\delta_{ni}$
- [umi](#) maximum displacement tangential to the grid plane  $\delta_{mi}$
- [unu](#) displacement normal to the ubiquitous plane  $\delta_{nu}$
- [umu](#) maximum displacement tangential to the ubiquitous plane  $\delta_{mu}$

### Thermal/Fluid Flow:

- [t](#) temperature/head
- [qt](#) total flow, its trend and plunge.
- [qx qy qz](#) Cartesian flow components.
- [qni](#) displacement normal to the grid plane.
- [qmi](#) maximum displacement tangential to the grid plane.
- [qnu](#) displacement normal to the ubiquitous plane.
- [qmu](#) maximum displacement tangential to the ubiquitous plane.

### Functions:

- [sin\(\)](#) [cos\(\)](#) [tan\(\)](#) sine, cosine and tangent trigonometric functions.
- [asin\(\)](#) [acos\(\)](#) [atan\(\)](#) Inverse trigonometric functions.
- [sqrt\(\)](#) square root function.
- [log\(\)](#) natural logarithmic function.
- [abs\(\)](#) absolute value.
- [exp\(\)](#) exponential function (antilogarithm).

- **n()** **an()** normal and inverse normal probability distribution. The argument used with the normal distribution is  $(\Delta\sigma_1/s)$  which represents the excess major principal stress divided by the standard deviation (see **N $\sigma_1$** , **N $\tau_{ip}$** , **N $\tau_{ub}$** ).
- **t()** **at()** t and inverse t probability distribution. The argument used with the t distribution is  $(\Delta\sigma_1/(sg), n-2)$  where  $\Delta\sigma_1$  represents the excess major principal stress, **s** represents the standard deviation, **n** represents the number of data points, and **g** represents the factor  $[1 + 1/n + (\sigma_3 - \sigma_m)^2/s_3^2/(n-1)]^{1/2}$  where  $\sigma_m$  represents the mean value of  $\sigma_3$ , and **s<sub>3</sub>** represents the standard deviation of  $\sigma_3$ .

#### Strength:

- **ds1** excess major principal stress  $\Delta\sigma_1$
- **dtmax** excess maximum shear stress  $\Delta\tau_{max}$
- **dtoct** excess octahedral shear stress  $\Delta\tau_{oct}$
- **dtip** excess in-plane shear stress  $\Delta\tau_{ip}$
- **dtub** excess ubiquitous-plane shear stress  $\Delta\tau_{ub}$
- **UCS phi q** Mohr-Coulomb strength parameters defined using **RM** [Plot > Strength Factors > Rockmass Strength Parameters](#).

#### Location:

- **x y z** coordinate of grid point.

#### Miscellaneous:

- **Dgrid** distance to the nearest surface from each grid point.
- **Dol** distance to the nearest grid **Dgrid** divided by the grid spacing **Lgrid**.
- **f1 f2...** user defined material parameters. These can be defined using [Plot > Properties > Material Properties > User defined Parameters](#).

#### Operators:

- **+ - \* / ^** addition, subtraction, multiplication, division and exponentiation operators. Note that exponentials are computed first, followed by multiplication and division and finally addition and subtraction.
- **() [] {}** styles of brackets. Pairs of brackets must match.
- **>** maximum value. For example if the plot equation is specified as  $s1 > 10$ , the larger of  $s1$  or 10 will be plotted.
- **<** minimum value. For example if the plot equation is specified as  $s1 < 10$ , the smaller of  $s1$  or 10 will be plotted.
- **" "** comment.

#### Other:

- **phi atan(Ti/Si)** plots the friction angle necessary to resist slip on a fault, joint set or bedding plane oriented in the same way as the grid plane.
- **Mohr-Coulomb  $60 + S3*\tan(45+30/2)^2$**  plots the strength for a Mohr-Coulomb criterion with a UCS of 60 and friction angle of 30°. The equation  $UCS + S3*q$  or alternatively  $UCS + S3*\tan(45 + phi/2)^2$  could also be used here if the strength parameters have been previously defined using **RM** [Plot > Strength Factors > Rockmass Strength Parameters](#).

- **T-distribution**  $T[\text{ds}1/\text{f}1/\text{sqrt}(1+1/\text{f}2+(\text{s}3-\text{f}3)^2/(\text{f}2-1)/\text{f}4^2), \text{f}2-2]*100$  plots the probability of failure using the t-distribution. Here  $\text{f}1$  represents the standard deviation  $s$ ,  $\text{f}2$  represents the number of data points  $n$ ,  $\text{f}3$  represents the mean value of  $\sigma_3$ , and  $\text{f}4$  represents the standard deviation of  $\sigma_3$ .  $\text{f}1$ ,  $\text{f}2$ ,  $\text{f}3$  and  $\text{f}4$  can be defined using [Plot > Properties > Material Properties > User defined Parameters](#) or the actual numeric values can be used.
- **Range** – sets the contour range.
- **Plot** – regenerates the contour plot.

The pull-down window allows you to store up to 20 different equations. These are stored between Map3D sessions in the map3d.ini file.

## 4.3.5 Thermal/Flux

### 4.3.5.1 Plot > Thermal/Flux

Activate the Thermal/Flux toolbar – after [Map3D Thermal-Fluid Flow](#) BEM analysis.

Parameters for Thermal/Flux Analysis are described in [Expansion Coefficient and Conductivity](#).



This toolbar is meant to provide quick access to thermal/flux components.

- t/h** Plot > Flux > t/h Temperature/Head
- q\_tot** Plot > Flux >  $q_{\text{total}} = (q_x^2 + q_y^2 + q_z^2)^{1/2}$  Total Flux contours the total displacement
- q\_x** Plot > Flux >  $q_x$  X-Flux contours the x-flux component
- q\_y** Plot > Flux >  $q_y$  Y-Flux contours the y-flux component
- q\_z** Plot > Flux >  $q_z$  Z-Flux contours the z-flux component

To calculate the in-plane flux, the flux state at each point on the grid plane is reoriented to determine the maximum flux parallel to the grid plane and the flux normal to the plane. Note that  $q_{ni}$  is oriented normal to the grid plane and parallel to the direction of a line grid.

- q\_ni** Plot > Flux >  $q_{ni}$  In-plane normal contours the flux component normal to the grid plane.
- q\_mi** Plot > Flux >  $q_{mi}$  In-plane maximum contours the maximum flux tangential to the grid plane.

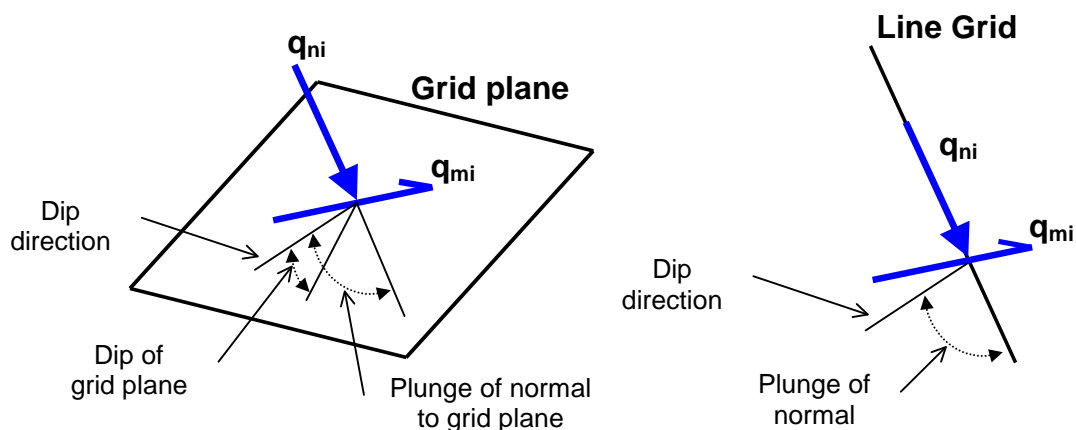

To calculate the ubiquitous-plane #1 flux, the flux state at each point on the grid plane is reoriented to determine the maximum flux parallel to the ubiquitous plane #1 and the flux normal to the plane. Note that  $\delta_{mi}$  is not oriented normal to the grid plane.

 [Plot > Flux > q<sub>nu</sub>](#) Ubiquitous-plane normal contours the flux component normal to the ubiquitous plane.

 [Plot > Flux > q<sub>mu</sub>](#) Ubiquitous-plane maximum contours the maximum flux tangential to the ubiquitous plane.

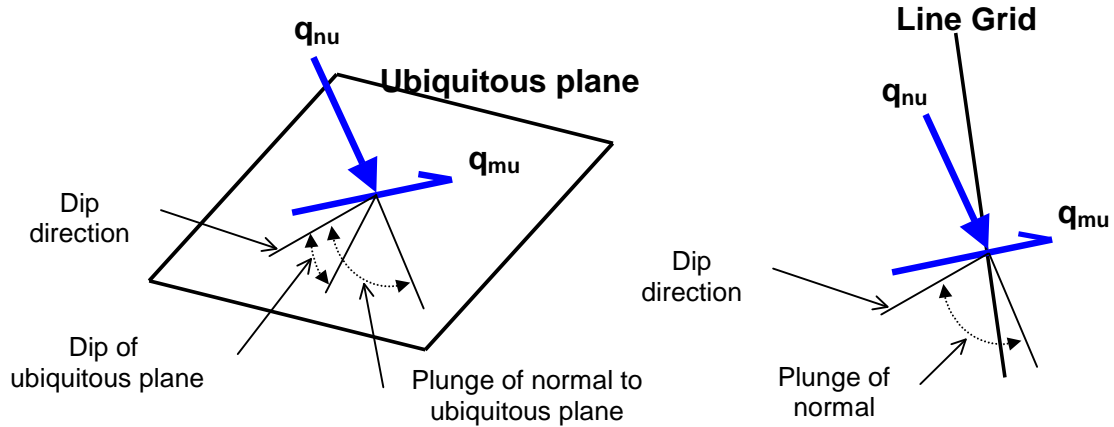

- **dip direction** is measured positive clockwise from the y-axis.
- **dip of the plane** is measured positive down from the horizontal (i.e. the dip direction).
- **plunge of the normal** is measured positive down (i.e. negative up) from the horizontal.

Notes:

The flux toolbar can only be activated after the model building - CAD Stage

[Map3D Analysis Stages.](#)

The orientation of the ubiquitous shear plane is set using

 [Plot > Strength Factors > Ubiquitous Parameters](#)

The contour range is set using

 [Plot > Range](#)

This component can be added to the contour toolbar if desired

 [Tools > Configure Contouring Toolbar > Displacement](#)

The user may find it handy to add the

 [More Flow Components](#)

button to the contouring toolbar for quick access to all flow components.



## 4.3.6 Strength Factors

### 4.3.6.1 Rock Mass Parameters

#### 4.3.6.1.1 Rockmass Strength Parameters

Sets up the strength parameters for generating strength factor contour plots in terms of principal stress components.

In elastic analysis the major and minor principal stresses can be used with the Mohr-Coulomb, Hoek-Brown or Drucker-Prager strength criteria to estimate the amount of damage due to over-stressing. Since none of the parameters have any orientation sensitivity, this criterion is representative for homogeneous rock mass stability.

By contrast, in non-linear analysis the stresses can never exceed the strength unless some creep is used. In this latter case, viscous creep can allow stress states above the failure criterion, thus indicating a lack of static equilibrium. Hence for non-linear analysis one normally directly considers the amount of non-linear strain or the strain rate predicted by the model

[Mohr-Coulomb in 3D FF blocks.](#)

#### Mohr-Coulomb

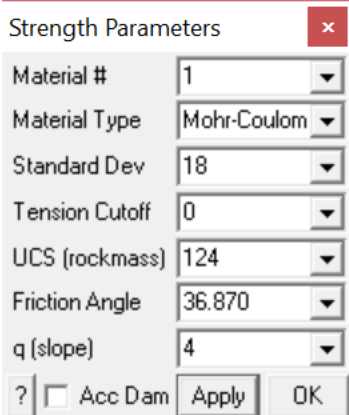

The screenshot shows a dialog box titled "Strength Parameters" with a close button (X) in the top right corner. The dialog contains several input fields, each with a dropdown arrow on the right:

- Material #: 1
- Material Type: Mohr-Coulomb
- Standard Dev: 18
- Tension Cutoff: 0
- UCS (rockmass): 124
- Friction Angle: 36.870
- q (slope): 4

At the bottom left, there is a question mark icon and a checkbox labeled "Acc Dam" which is currently unchecked. To the right of the checkbox are two buttons: "Apply" and "OK".

**Material #** specifies the material number. Material #1 represents the host material. Other material numbers are used to define alternate material zones such as ore, fault gouge, backfill etc.

**Standard Deviation** specifies the uncertainty you have in the failure criterion measured in the  $\sigma_1$  direction.

**Material Type** specifies the material type: Mohr-Coulomb, Hoek-Brown, Drucker-Prager or None.

**Tension Cutoff, UCS, Friction Angle** the Mohr-Coulomb criterion defines strength in terms of principal stresses as follows:

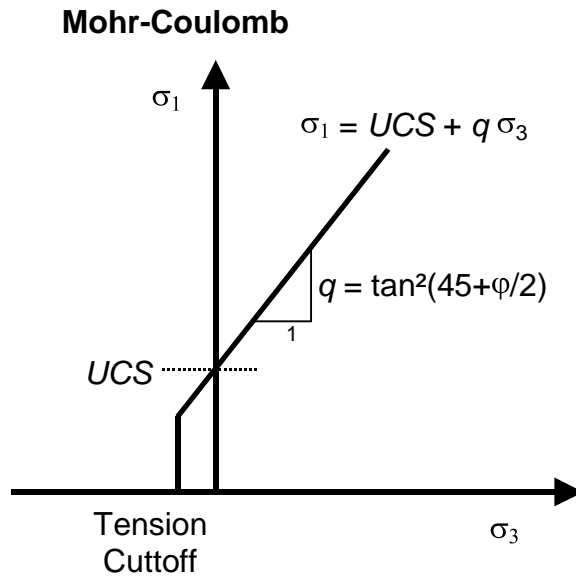

**Tension cutoff** and **UCS** are specified in units of stress (MPa or psi). Friction angle is specified in degrees.

**Apply** – regenerates the contour plot.

**Acc Dam** – plots accumulated damage. Refer to [Accumulated Damage](#)

### Hoek-Brown

Strength Parameters		×
Material #	1	▼
Material Type	Hoek-Brown	▼
Standard Dev	18	▼
Tension Cutoff	0	▼
Sigma:C (lab)	240	▼
m Hoek-Brown	8.200	▼
s Hoek-Brown	0.030	▼
<input type="checkbox"/> Acc Dam		<input type="button" value="Apply"/> <input type="button" value="OK"/>

**Material #** specifies the material number. Material #1 represents the host material. Other material numbers are used to define alternate material zones such as ore, fault gouge, backfill etc.

**Material Type** specifies the material type: Mohr-Coulomb, Hoek-Brown, Drucker-Prager or None.

**Standard Deviation** specifies the uncertainty you have in the failure criterion measured in the  $\sigma_1$  direction (specified in units of stress, MPa or psi).

**Tension Cutoff**, **Sigma:C**, **m** and **s** the Hoek-Brown criterion defines strength in terms of principal stresses as follows:

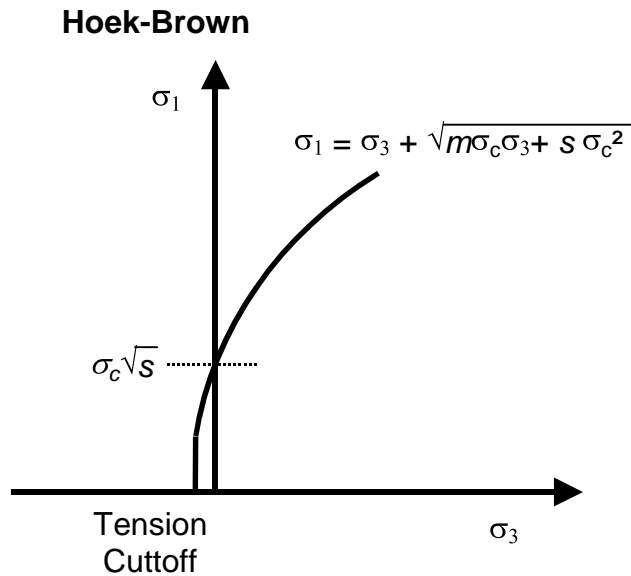

**Tension cutoff** and **Sigma:C** are specified in units of stress (MPa or psi).

**Apply** – regenerates the contour plot.

**Acc Dam** – plots accumulated damage. Refer to [Accumulated Damage](#)

### Drucker-Prager

Strength Parameters	
Material #	1
Material Type	Drucker-Prag
Standard Dev	18
Tension Cutoff	0
UCS (rockmass)	124
Friction Angle	36.870
q (slope)	4
<input type="checkbox"/> Acc Dam	<input type="button" value="Apply"/> <input type="button" value="OK"/>

**Material #** specifies the material number. Material #1 represents the host material. Other material numbers are used to define alternate material zones such as ore, fault gouge, backfill etc.

**Material Type** specifies the material type: Mohr-Coulomb, Hoek-Brown, Drucker-Prager or None.

**Standard Deviation** specifies the uncertainty you have in the failure criterion measured in the  $\tau_{oct}$  direction.

**Tension Cutoff**, **UCS**, **Friction Angle** the Drucker-Prager criterion defines strength in terms of principal stresses as follows:

## Drucker-Prager

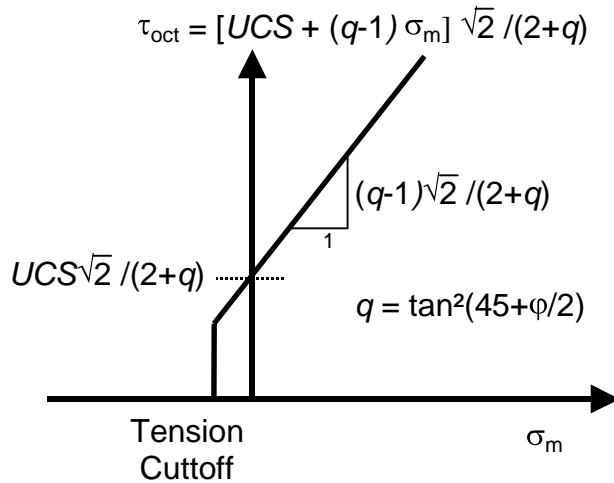

where

$$\tau_{oct} = 1/3 [(\sigma_1 - \sigma_2)^2 + (\sigma_2 - \sigma_3)^2 + (\sigma_3 - \sigma_1)^2]^{1/2}$$

$$\sigma_{mean} = 1/3 (\sigma_1 + \sigma_2 + \sigma_3)$$













Tension cutoff and UCS are specified in units of stress (MPa or psi). Friction angle is specified in degrees.

Note that the strength parameters have been chosen so that the criterion simplifies to the Mohr-Coulomb criterion when  $\sigma_2$  equals  $\sigma_3$ .

**Apply** – regenerates the contour plot.

**Acc Dam** – plots accumulated damage. Refer to [Accumulated Damage](#)

### Related topics:

-  [Plot > Strength Factor > Probability N-distribution](#)
-   [Plot > Strength Factor > SF-A - Strength/Stress](#)
-   [Plot > Strength Factor > SF-B - Strength/Stress](#)
-   [Plot > Strength Factors > SF-C - Strength/Stress](#)
-  [Plot > Strength Factors > dS1 - Excess Stress](#)
-  [Plot > Strength Factors > dTmax - Excess Stress](#)
-  [Plot > Strength Factors > dToct - Excess Stress](#)
-  [Plot > Strength Factors > In-plane Parameters](#)
-  [Plot > Strength Factors > Ubiquitous Parameters](#)

#### 4.3.6.1.2 Accumulated Damage

Plot Accumulated Damage.

When not activated, the Excess Stress, Probability of Failure and Strength Factor are plotted for the current stress values.

When activated, damage is tracked from step 1 to the current step throughout the model loading history, and the worst case for Excess Stress, Probability of Failure or Strength Factor is plotted. This allows elastic stress analysis results to be used in a manner similar to accumulated strain in a plasticity model.

Damage tracking is done separately for the 5 following cases:

1. Rock Mass failure ([Excess S1 Stress, Probability, Strength Factor](#))
2. In-Plane Shear failure ([Excess Shear Stress, Probability, Strength Factor](#))
3. Ub-Plane Shear failure ([Excess Shear Stress, Probability, Strength Factor](#))
4. In-Plane Excess Wall Stress (Excess Stress, RCF)
5. Ub-Plane Excess Wall Stress (Excess Stress, RCF)

Note that both the step at which first yield occurs [MStep 1st Yield](#), and the step at which the maximum excess stress occurs [MStep Max Yield](#), are tracked and can be displayed as trajectory labels.

#### 4.3.6.1.3 S1 Excess Stress

Contours the strength using method "A".

In elastic analysis the major and minor principal stresses can be used with the Mohr-Coulomb or Hoek-Brown strength criteria

 [Plot > Strength Factors > Strength Parameters](#)

to estimate the amount of damage due to over-stressing. Since none of the parameters have any orientation sensitivity, this criterion is representative for homogeneous rock mass stability.

By contrast, in non-linear analysis the stresses can never exceed the strength unless some creep is used. In this latter case, viscous creep can allow stress states above the failure criterion, thus indicating a lack of static equilibrium. Hence for non-linear analysis one normally directly considers the amount of non-linear strain or the strain rate predicted by the model

[Mohr-Coulomb in 3D FF blocks.](#)

Method "A" assumes that the stress path to failure takes place by increasing  $\sigma_1$  without loss of confinement. This is representative of a pillar failure where  $\sigma_1$  is considered to be the driving force.

### Mohr-Coulomb

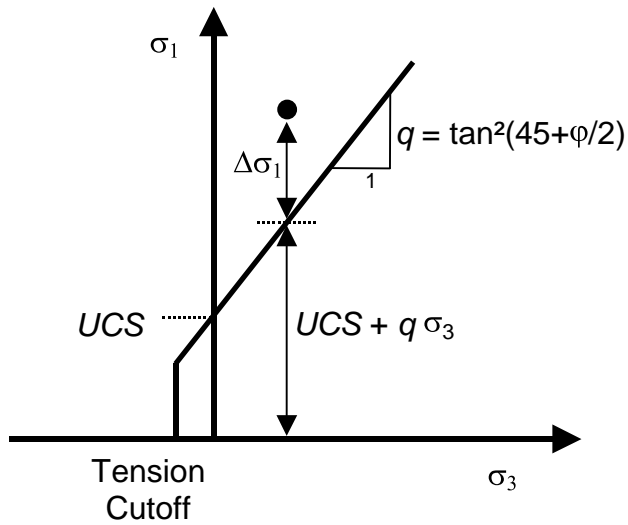

- SF-A Plot > Strength Factors > SF-A Strength/Stress can be determined as  $(UCS + q\sigma_3) / \sigma_1$
- SF/A Plot > Strength Factors > SF/A Strength/Stress can be determined as  $\sigma_1 / (UCS + q\sigma_3)$
- $\Delta\sigma_1$  Plot > Strength Factors >  $\Delta\sigma_1$  excess stress can be determined as  $\Delta\sigma_1 = \sigma_1 - (UCS + q\sigma_3)$
- $N\sigma_1$  Plot > Strength Factors >  $N(\Delta\sigma_1/std)$  Probability using the Normal distribution.

the same as in [method "B"](#).

### Hoek-Brown

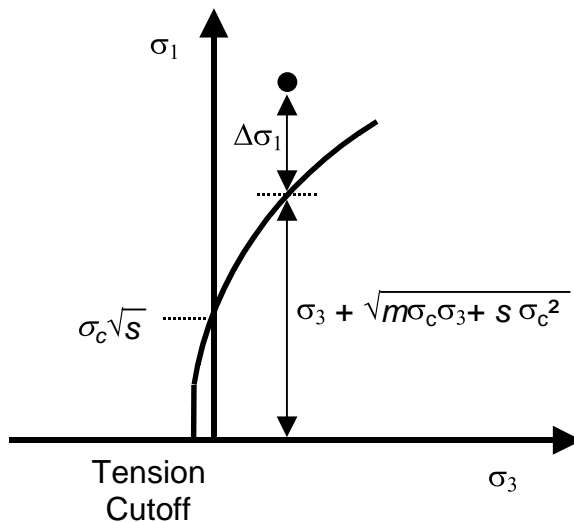

- SF-A Plot > Strength Factors > SF-A Strength/Stress can be determined as  $[\sigma_3 + \sqrt{(m\sigma_c\sigma_3 + s\sigma_c^2)}] / \sigma_1$
- SF/A Plot > Strength Factors > SF/A Strength/Stress can be determined as  $\sigma_1 / [\sigma_3 + \sqrt{(m\sigma_c\sigma_3 + s\sigma_c^2)}]$

$\sigma_c^2]$

**$\Delta\sigma_1$**  [Plot > Strength Factors >  \$\Delta\sigma\_1\$](#)  excess stress can be determined as  $\Delta\sigma_1 = \sigma_1 - [\sigma_3 + \sqrt{(m\sigma_c\sigma_3 + s\sigma_c^2)}]$

**$N\sigma_1$**  [Plot > Strength Factors >  \$N\(\Delta\sigma\_1/std\)\$](#)  Probability using the Normal distribution.

the same as in [method "B"](#).

Drucker-Prager is only defined using [method "C"](#).

Strength parameters are setup using

**RM** [Plot > Strength Factors > Strength Parameters](#)

Related topics:

**SF-B** [Plot > Strength Factor > SF-B - Strength/Stress](#)

**SF-C** [Plot > Strength Factors > SF-C - Strength/Stress](#)

**$\Delta T_m$**  [Plot > Strength Factors > dTmax - Excess Stress](#)

**$\Delta T_{oct}$**  [Plot > Strength Factors > dToct - Excess Stress](#)

**IP** [Plot > Strength Factors > In-plane Parameters](#)

**UB** [Plot > Strength Factors > Ubiquitous Parameters](#)

#### 4.3.6.1.4 Tmax Excess Stress

Contours the strength using method "C".

In elastic analysis the major and minor principal stresses can be used with the Mohr-Coulomb or Hoek-Brown strength criteria

**RM** [Plot > Strength Factors > Strength Parameters](#)

to estimate the amount of damage due to over-stressing. Since none of the parameters have any orientation sensitivity, this criterion is representative for homogeneous rock mass stability.

By contrast, in non-linear analysis the stresses can never exceed the strength unless some creep is used. In this latter case, viscous creep can allow stress states above the failure criterion, thus indicating a lack of static equilibrium. Hence for non-linear analysis one normally directly considers the amount of non-linear strain or the strain rate predicted by the model

[Mohr-Coulomb in 3D FF blocks.](#)

Method "C" assumes that the stress path to failure takes place by increasing  $\sigma_1$  while loosing confinement. This is representative of an abutment failure where  $\sigma_1 - \sigma_3$  is considered to be the driving force.

### Mohr-Coulomb

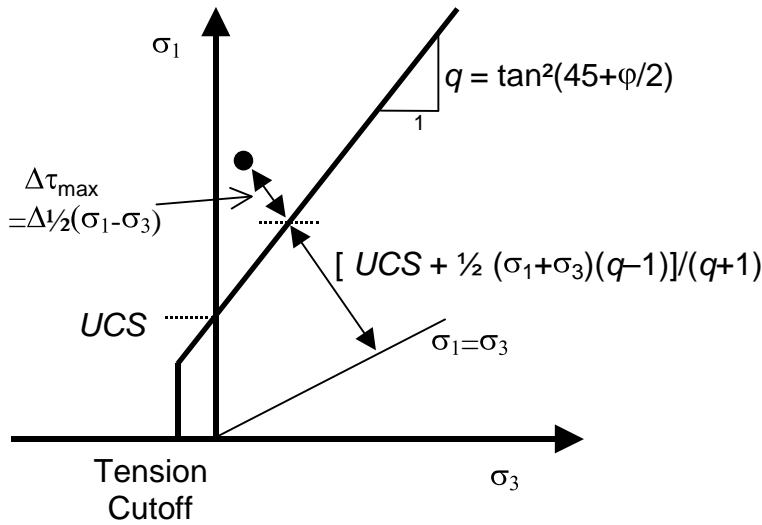

**SF-C** Plot > Strength Factors > SF-C Strength/Stress can be determined as  $[\text{UCS} + \frac{1}{2}(\sigma_1 + \sigma_3)(q-1)] / [\frac{1}{2}(\sigma_1 - \sigma_3)(q+1)]$

**SF/C** Plot > Strength Factors > SF/C Strength/Stress can be determined as  $[\frac{1}{2}(\sigma_1 - \sigma_3)(q+1)] / [\text{UCS} + \frac{1}{2}(\sigma_1 + \sigma_3)(q-1)]$

**$\Delta\tau_m$**  Plot > Strength Factors >  $\Delta\tau_{\text{max}}$  excess stress can be determined as

$$\Delta\tau_{\text{max}} = \frac{1}{2}(\sigma_1 - \sigma_3) - [\text{UCS} + \frac{1}{2}(\sigma_1 + \sigma_3)(q-1)] / (q+1)$$

$$= [\sigma_1 - (\text{UCS} + q \sigma_3)] / (q+1)$$

### Hoek-Brown

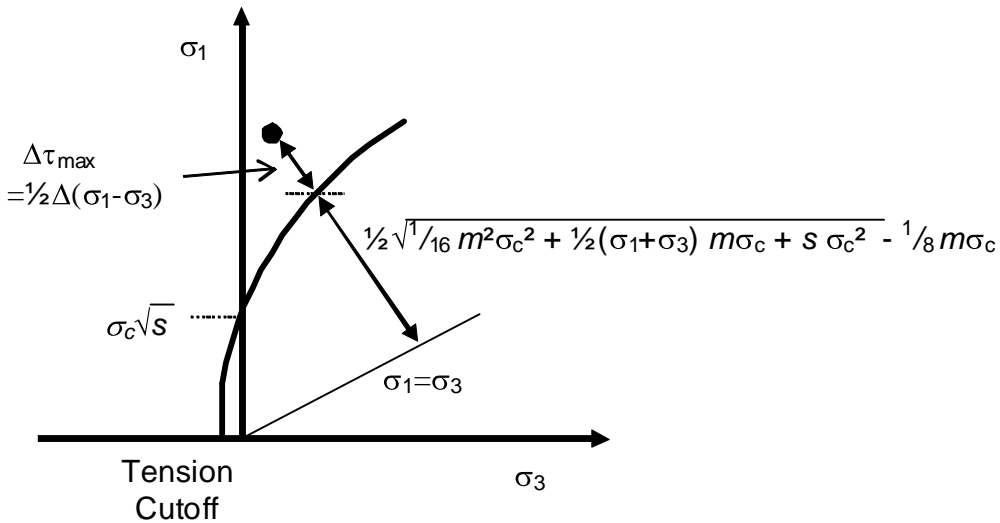

**SF-C** Plot > Strength Factors > SF-C Strength/Stress can be determined as  $\{ \sqrt{[\frac{1}{16} m^2 \sigma_c^2 + \frac{1}{2}(\sigma_1 + \sigma_3) m \sigma_c + s \sigma_c^2]} - \frac{1}{8} m \sigma_c \} / [\frac{1}{2}(\sigma_1 - \sigma_3)]$



$$\sigma_3) m\sigma_c + s\sigma_c^2] - \frac{1}{4} m\sigma_c / (\sigma_1 - \sigma_3)$$

**SF/C** Plot > Strength Factors > SF/C Strength/Stress can be determined as  $(\sigma_1 - \sigma_3) / \{ \sqrt{[ \frac{1}{16} m^2 \sigma_c^2 + \frac{1}{2} (\sigma_1 + \sigma_3) m\sigma_c + s\sigma_c^2 ] - \frac{1}{4} m\sigma_c} \}$

**Δτ<sub>m</sub>** Plot > Strength Factors > Δτ<sub>max</sub> excess stress can be determined as

$$\Delta\tau_{\max} = \frac{1}{2}(\sigma_1 - \sigma_3) - \frac{1}{2} \{ \sqrt{[ \frac{1}{16} m^2 \sigma_c^2 + \frac{1}{2} (\sigma_1 + \sigma_3) m\sigma_c + s\sigma_c^2 ] - \frac{1}{4} m\sigma_c} \}$$

### Drucker-Prager

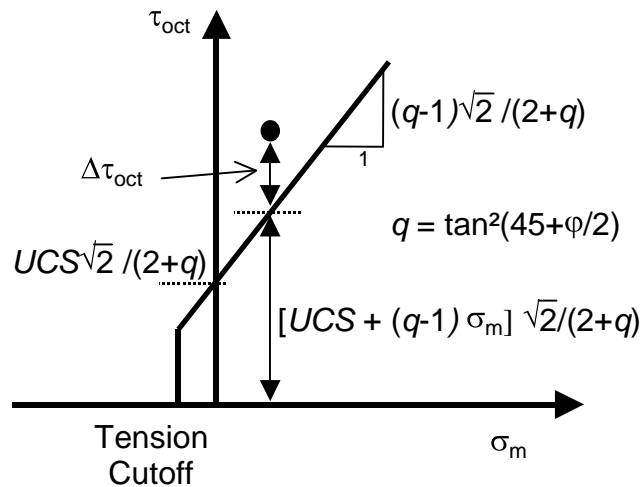

**SF-C** SF-C Strength/Stress can be determined as  $[ UCS + (q-1) \sigma_{\text{mean}} ] \sqrt{2} / [ \tau_{\text{oct}} (q+2) ]$

**SF/C** SF-C Stress/Strength can be determined as  $\tau_{\text{oct}} / [ UCS + (q-1) \sigma_{\text{mean}} ] \sqrt{2} / (q+2)$

**Δτ<sub>oct</sub>** Dtoct Excess can be determined as  $\tau_{\text{oct}} - [ UCS + (q-1) \sigma_{\text{mean}} ] \sqrt{2} / (q+2)$

where

$$q = \tan^2(45 + \phi/2)$$

$$\tau_{\text{oct}} = \frac{1}{3} \sqrt{[(\sigma_1 - \sigma_2)^2 + (\sigma_2 - \sigma_3)^2 + (\sigma_3 - \sigma_1)^2]}$$

$$\sigma_{\text{mean}} = \frac{1}{3} (\sigma_1 + \sigma_2 + \sigma_3)$$

Note that the strength parameters have been chosen so that the criterion simplifies to the Mohr-Coulomb criterion when  $\sigma_2$  equals  $\sigma_3$ .

Strength parameters are setup using

**RM** Plot > Strength Factors > Strength Parameters

Related topics:

**SF-A** **SF/A** Plot > Strength Factor > SF-A - Stress/Strength

**SF-B** **SF/B** Plot > Strength Factors > SF-B - Stress/Strength

**Δσ<sub>1</sub>** Plot > Strength Factors > ΔS1 - Excess Stress

**IP** Plot > Strength Factors > In-plane Parameters

**UB** Plot > Strength Factors > Ubiquitous Parameters

## 4.3.6.1.6 NS1 Normal Probability

Contours the strength using method "A".

In elastic analysis the major and minor principal stresses can be used with the Mohr-Coulomb or Hoek-Brown strength criteria

**BM** [Plot > Strength Factors > Strength Parameters](#)

to estimate the amount of damage due to over-stressing. Since none of the parameters have any orientation sensitivity, this criterion is representative for homogeneous rock mass stability.

By contrast, in non-linear analysis the stresses can never exceed the strength unless some creep is used. In this latter case, viscous creep can allow stress states above the failure criterion, thus indicating a lack of static equilibrium. Hence for non-linear analysis one normally directly considers the amount of non-linear strain or the strain rate predicted by the model

[Mohr-Coulomb in 3D FF blocks.](#)

Method "A" assumes that the stress path to failure takes place by increasing  $\sigma_1$  without loss of confinement. This is representative of a pillar failure where  $\sigma_1$  is considered to be the driving force.

### Mohr-Coulomb

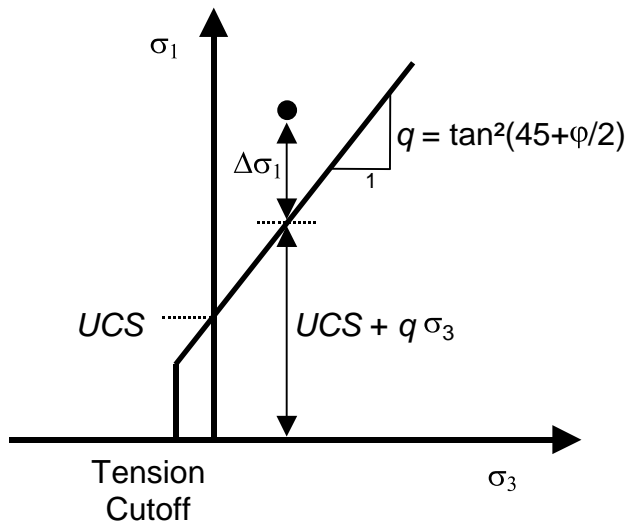

**SF-A** [Plot > Strength Factors > SF-A](#) Strength/Stress can be determined as  $(UCS + q\sigma_3) / \sigma_1$

**SF/A** [Plot > Strength Factors > SF/A](#) Strength/Stress can be determined as  $\sigma_1 / (UCS + q\sigma_3)$

**Δσ₁** [Plot > Strength Factors > Δσ₁](#) excess stress can be determined as  $\Delta\sigma_1 = \sigma_1 - (UCS + q\sigma_3)$

**NG₁** [Plot > Strength Factors > N\(Δσ₁/std\)](#) Probability using the Normal distribution.

the same as in [method "B"](#).

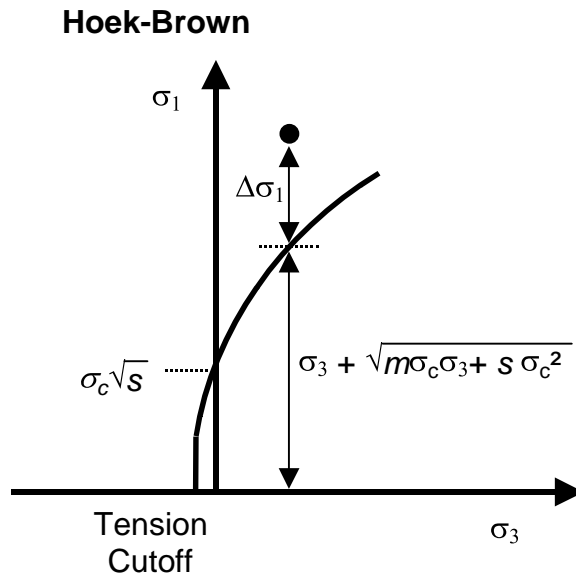

**SF-A** Plot > Strength Factors > SF-A Strength/Stress can be determined as  $[\sigma_3 + \sqrt{(m \sigma_c \sigma_3 + s \sigma_c^2)}] / \sigma_1$

**SF/A** Plot > Strength Factors > SF/A Strength/Stress can be determined as  $\sigma_1 / [\sigma_3 + \sqrt{(m \sigma_c \sigma_3 + s \sigma_c^2)}]$

**Δσ<sub>1</sub>** Plot > Strength Factors > Δσ<sub>1</sub> excess stress can be determined as  $\Delta \sigma_1 = \sigma_1 - [\sigma_3 + \sqrt{(m \sigma_c \sigma_3 + s \sigma_c^2)}]$

**N<sub>G1</sub>** Plot > Strength Factors > N(Δσ<sub>1</sub>/std) Probability using the Normal distribution.

the same as in [method "B"](#).

Drucker-Prager is only defined using [method "C"](#).

Strength parameters are setup using

**RM** [Plot > Strength Factors > Strength Parameters](#)

Related topics:

**SF-B** [Plot > Strength Factor > SF-B - Strength/Stress](#)

**SF-C** [Plot > Strength Factors > SF-C - Strength/Stress](#)

**ΔT<sub>m</sub>** [Plot > Strength Factors > dTmax - Excess Stress](#)

**ΔT<sub>oct</sub>** [Plot > Strength Factors > dToct - Excess Stress](#)

**IP** [Plot > Strength Factors > In-plane Parameters](#)

**UB** [Plot > Strength Factors > Ubiquitous Parameters](#)

#### 4.3.6.1.8 SF-B Strength/Stress

Contours the strength using method "B".

In elastic analysis the major and minor principal stresses can be used with the Mohr-Coulomb or Hoek-Brown strength criteria

**RM** [Plot > Strength Factors > Strength Parameters](#)

to estimate the amount of damage due to over-stressing. Since none of the parameters have any orientation sensitivity, this criterion is representative for homogeneous rock mass stability.

By contrast, in non-linear analysis the stresses can never exceed the strength unless some creep is used. In this latter case, viscous creep can allow stress states above the failure criterion, thus indicating a lack of static equilibrium. Hence for non-linear analysis one normally directly considers the amount of non-linear strain or the strain rate predicted by the model

[Mohr-Coulomb in 3D FF blocks.](#)

Method "B" assumes that the stress path to failure takes place by increasing  $\sigma_1$  without loss of confinement. This is representative of a pillar failure where  $\sigma_1 - \sigma_3$  is considered to be the driving force.

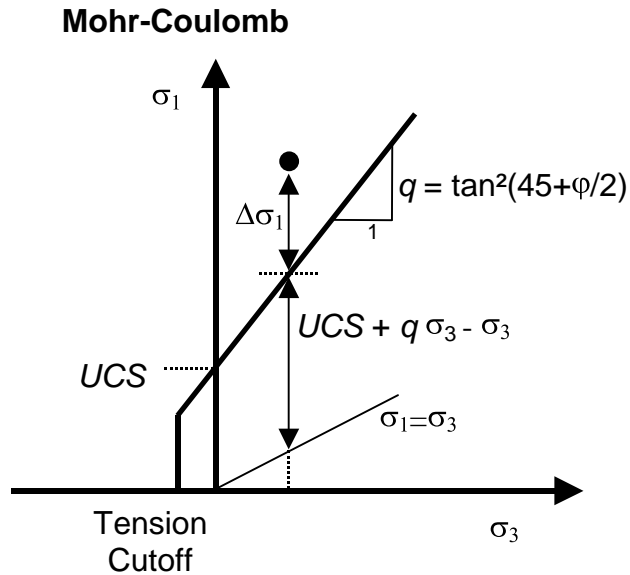

**SF-B** [Plot > Strength Factors > SF-B](#) Strength/Stress can be determined as  $(UCS + q\sigma_3 - \sigma_3)/(\sigma_1 - \sigma_3)$

**SF/B** [Plot > Strength Factors > SF/B](#) Strength/Stress can be determined as  $(\sigma_1 - \sigma_3)/(UCS + q\sigma_3 - \sigma_3)$

**$\Delta\sigma_1$**  [Plot > Strength Factors >  \$\Delta\sigma\_1\$](#)  excess stress can be determined as  $\Delta\sigma_1 = \sigma_1 - (UCS + q\sigma_3)$

**$N\sigma_1$**  [Plot > Strength Factors >  \$N\(\Delta\sigma\_1/std\)\$](#)  Probability using the Normal distribution.

the same as in [method "A"](#).

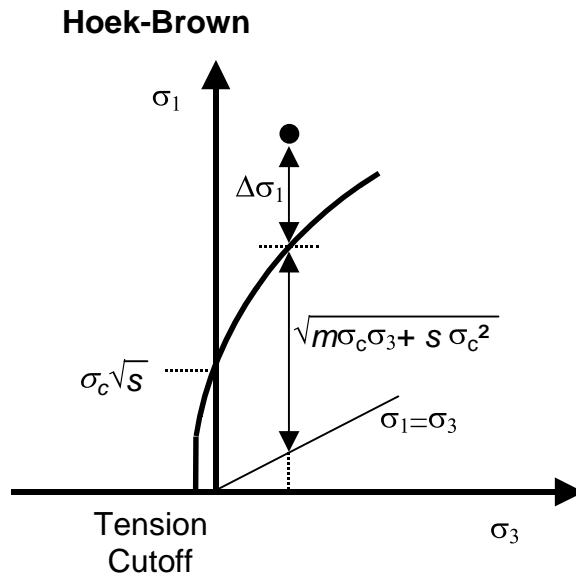

- SF-B** [Plot > Strength Factors > SF-B](#) Strength/Stress can be determined as  $\sqrt{(m\sigma_c\sigma_3 + s\sigma_c^2)/(\sigma_1 - \sigma_3)}$
- SF/B** [Plot > Strength Factors > SF/B](#) Strength/Stress can be determined as  $(\sigma_1 - \sigma_3)/\sqrt{(m\sigma_c\sigma_3 + s\sigma_c^2)}$
- Delta sigma\_1** [Plot > Strength Factors > Delta sigma\\_1](#) excess stress can be determined as  $\Delta\sigma_1 = \sigma_1 - [\sigma_3 + \sqrt{(m\sigma_c\sigma_3 + s\sigma_c^2)}]$
- N sigma\_1** [Plot > Strength Factors > N\(Delta sigma\\_1/std\)](#) Probability using the Normal distribution.

the same as in [method "A"](#).

Drucker-Prager is only defined using [method "C"](#).

Strength parameters are setup using

**RM** [Plot > Strength Factors > Strength Parameters](#)

Related topics:

- SF-A** [Plot > Strength Factor > SF-A - Strength/Stress](#)
- SF-C** [Plot > Strength Factors > SF-C - Strength/Stress](#)
- Delta T\_m** [Plot > Strength Factors > dTmax - Excess Stress](#)
- Delta T\_oct** [Plot > Strength Factors > dToct - Excess Stress](#)
- IP** [Plot > Strength Factors > In-plane Parameters](#)
- UB** [Plot > Strength Factors > Ubiquitous Parameters](#)

#### 4.3.6.1.9 SF-C Strength/Stress

Contours the strength using method "C".

In elastic analysis the major and minor principal stresses can be used with the Mohr-Coulomb or Hoek-Brown strength criteria

**RM** [Plot > Strength Factors > Strength Parameters](#)

to estimate the amount of damage due to over-stressing. Since none of the parameters have any orientation sensitivity, this criterion is representative for homogeneous rock mass stability.

By contrast, in non-linear analysis the stresses can never exceed the strength unless some creep is used. In this latter case, viscous creep can allow stress states above the failure criterion, thus indicating a lack of static equilibrium. Hence for non-linear analysis one normally directly considers the amount of non-linear strain or the strain rate predicted by the model

#### [Mohr-Coulomb in 3D FF blocks.](#)

Method "C" assumes that the stress path to failure takes place by increasing  $\sigma_1$  while loosing confinement. This is representative of an abutment failure where  $\sigma_1 - \sigma_3$  is considered to be the driving force.

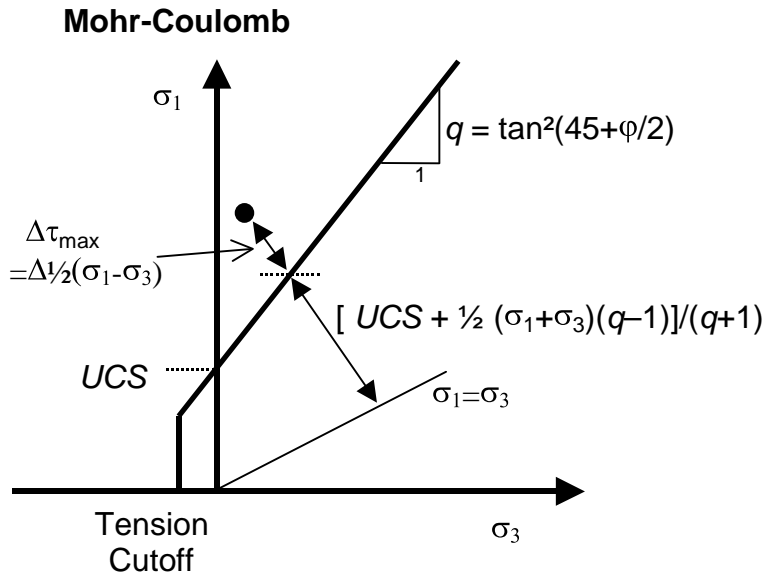

**SF-C** Plot > Strength Factors > SF-C Strength/Stress can be determined as  $[ UCS + \frac{1}{2}(\sigma_1 + \sigma_3) (q-1) ] / [ \frac{1}{2}(\sigma_1 - \sigma_3)(q+1) ]$

**SF/C** Plot > Strength Factors > SF/C Strength/Stress can be determined as  $[ \frac{1}{2}(\sigma_1 - \sigma_3)(q+1) ] / [ UCS + \frac{1}{2}(\sigma_1 + \sigma_3) (q-1) ]$

**Delta tau\_m** Plot > Strength Factors >  $\Delta\tau_{max}$  excess stress can be determined as

$$\begin{aligned} \Delta\tau_{max} &= \frac{1}{2}(\sigma_1 - \sigma_3) - [ UCS + \frac{1}{2}(\sigma_1 + \sigma_3) (q-1) ] / (q+1) \\ &= [ \sigma_1 - ( UCS + q \sigma_3 ) ] / (q+1) \end{aligned}$$

### Hoek-Brown

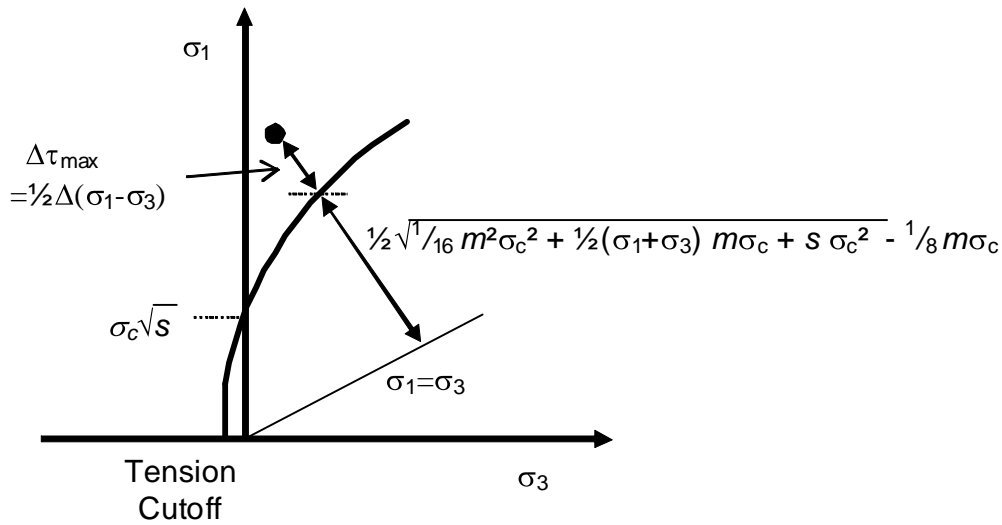

**SF-C** Plot > Strength Factors > SF-C Strength/Stress can be determined as  $\{ \sqrt{[\frac{1}{16}m^2\sigma_c^2 + \frac{1}{2}(\sigma_1 + \sigma_3)m\sigma_c + s\sigma_c^2]} - \frac{1}{4}m\sigma_c \} / (\sigma_1 - \sigma_3)$

**SF/C** Plot > Strength Factors > SF/C Strength/Stress can be determined as  $(\sigma_1 - \sigma_3) / \{ \sqrt{[\frac{1}{16}m^2\sigma_c^2 + \frac{1}{2}(\sigma_1 + \sigma_3)m\sigma_c + s\sigma_c^2]} - \frac{1}{4}m\sigma_c \}$

**Δτ<sub>m</sub>** Plot > Strength Factors > Δτ<sub>max</sub> excess stress can be determined as

$$\Delta\tau_{max} = \frac{1}{2}(\sigma_1 - \sigma_3) - \frac{1}{2}\{ \sqrt{[\frac{1}{16}m^2\sigma_c^2 + \frac{1}{2}(\sigma_1 + \sigma_3)m\sigma_c + s\sigma_c^2]} - \frac{1}{4}m\sigma_c \}$$

### Drucker-Prager

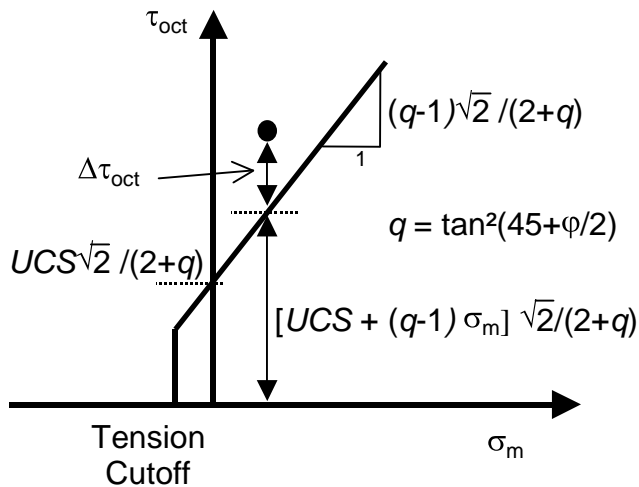

**SF-C** SF-C Strength/Stress can be determined as  $[UCS + (q-1)\sigma_{mean}]\sqrt{2}/[\tau_{oct}(q+2)]$

**SF/C** SF-C Stress/Strength can be determined as  $\tau_{oct}/[UCS + (q-1)\sigma_{mean}]\sqrt{2}/(q+2)$

 **Dtact Excess** can be determined as  $\tau_{oct} - [ UCS + (q-1) \sigma_{mean} ] \sqrt{2} / (q+2)$

where

$$q = \tan^2(45 + \phi/2)$$

$$\tau_{oct} = 1/3 \sqrt{[(\sigma_1 - \sigma_2)^2 + (\sigma_2 - \sigma_3)^2 + (\sigma_3 - \sigma_1)^2]}$$

$$\sigma_{mean} = 1/3 (\sigma_1 + \sigma_2 + \sigma_3)$$

Note that the strength parameters have been chosen so that the criterion simplifies to the Mohr-Coulomb criterion when  $\sigma_2$  equals  $\sigma_3$ .

Strength parameters are setup using

 [Plot > Strength Factors > Strength Parameters](#)

Related topics:

 [Plot > Strength Factor > SF-A - Stress/Strength](#)

 [Plot > Strength Factors > SF-B - Stress/Strength](#)

 [Plot > Strength Factors > dS1 - Excess Stress](#)

 [Plot > Strength Factors > In-plane Parameters](#)

 [Plot > Strength Factors > Ubiquitous Parameters](#)

#### 4.3.6.1.10 SF/A Stress/Strength

Contours the strength using method "A".

In elastic analysis the major and minor principal stresses can be used with the Mohr-Coulomb or Hoek-Brown strength criteria

 [Plot > Strength Factors > Strength Parameters](#)

to estimate the amount of damage due to over-stressing. Since none of the parameters have any orientation sensitivity, this criterion is representative for homogeneous rock mass stability.

By contrast, in non-linear analysis the stresses can never exceed the strength unless some creep is used. In this latter case, viscous creep can allow stress states above the failure criterion, thus indicating a lack of static equilibrium. Hence for non-linear analysis one normally directly considers the amount of non-linear strain or the strain rate predicted by the model

[Mohr-Coulomb in 3D FF blocks.](#)

Method "A" assumes that the stress path to failure takes place by increasing  $\sigma_1$  without loss of confinement. This is representative of a pillar failure where  $\sigma_1$  is considered to be the driving force.



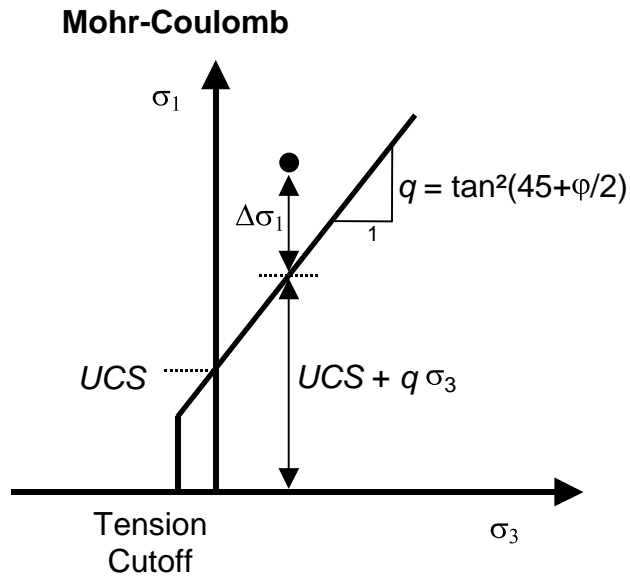

- SF-A** Plot > Strength Factors > SF-A Strength/Stress can be determined as  $(UCS + q \sigma_3) / \sigma_1$
- SF/A** Plot > Strength Factors > SF/A Strength/Stress can be determined as  $\sigma_1 / (UCS + q \sigma_3)$
- $\Delta\sigma_1$**  Plot > Strength Factors >  $\Delta\sigma_1$  excess stress can be determined as  $\Delta\sigma_1 = \sigma_1 - (UCS + q \sigma_3)$
- $N\sigma_1$**  Plot > Strength Factors >  $N(\Delta\sigma_1/std)$  Probability using the Normal distribution.

the same as in [method "B"](#).

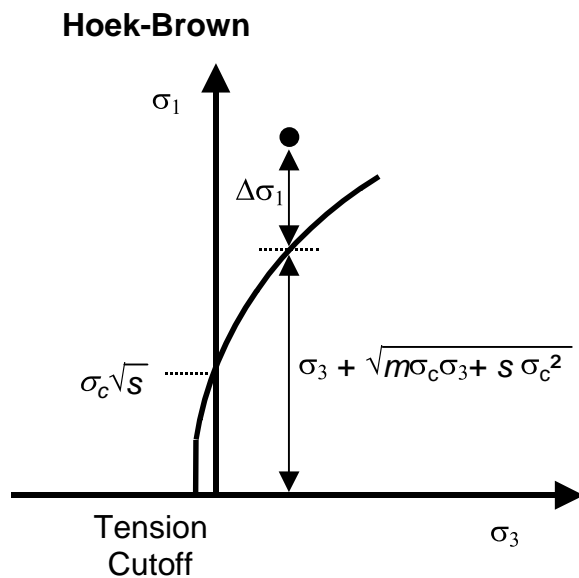

- SF-A** Plot > Strength Factors > SF-A Strength/Stress can be determined as  $[\sigma_3 + \sqrt{(m \sigma_c \sigma_3 + s \sigma_c^2)}] / \sigma_1$
- SF/A** Plot > Strength Factors > SF/A Strength/Stress can be determined as  $\sigma_1 / [\sigma_3 + \sqrt{(m \sigma_c \sigma_3 + s \sigma_c^2)}]$

$\sigma_c^2)$  ]

**$\Delta\sigma_1$**  [Plot > Strength Factors >  \$\Delta\sigma\_1\$](#)  excess stress can be determined as  $\Delta\sigma_1 = \sigma_1 - [\sigma_3 + \sqrt{(m\sigma_c\sigma_3 + s\sigma_c^2)}]$

**$N_{G1}$**  [Plot > Strength Factors >  \$N\(\Delta\sigma\_1/std\)\$](#)  Probability using the Normal distribution.

the same as in [method "B"](#).

Drucker-Prager is only defined using [method "C"](#).

Strength parameters are setup using

**RM** [Plot > Strength Factors > Strength Parameters](#)

Related topics:

**SF-B** [Plot > Strength Factor > SF-B - Strength/Stress](#)

**SF-C** [Plot > Strength Factors > SF-C - Strength/Stress](#)

**$\Delta T_m$**  [Plot > Strength Factors > dTmax - Excess Stress](#)

**$\Delta T_{oct}$**  [Plot > Strength Factors > dToct - Excess Stress](#)

**IP** [Plot > Strength Factors > In-plane Parameters](#)

**UB** [Plot > Strength Factors > Ubiquitous Parameters](#)

#### 4.3.6.1.11 SF/B Stress/Strength

Contours the strength using method "B".

In elastic analysis the major and minor principal stresses can be used with the Mohr-Coulomb or Hoek-Brown strength criteria

**RM** [Plot > Strength Factors > Strength Parameters](#)

to estimate the amount of damage due to over-stressing. Since none of the parameters have any orientation sensitivity, this criterion is representative for homogeneous rock mass stability.

By contrast, in non-linear analysis the stresses can never exceed the strength unless some creep is used. In this latter case, viscous creep can allow stress states above the failure criterion, thus indicating a lack of static equilibrium. Hence for non-linear analysis one normally directly considers the amount of non-linear strain or the strain rate predicted by the model

[Mohr-Coulomb in 3D FF blocks.](#)

Method "B" assumes that the stress path to failure takes place by increasing  $\sigma_1$  without loss of confinement. This is representative of a pillar failure where  $\sigma_1 - \sigma_3$  is considered to be the driving force.

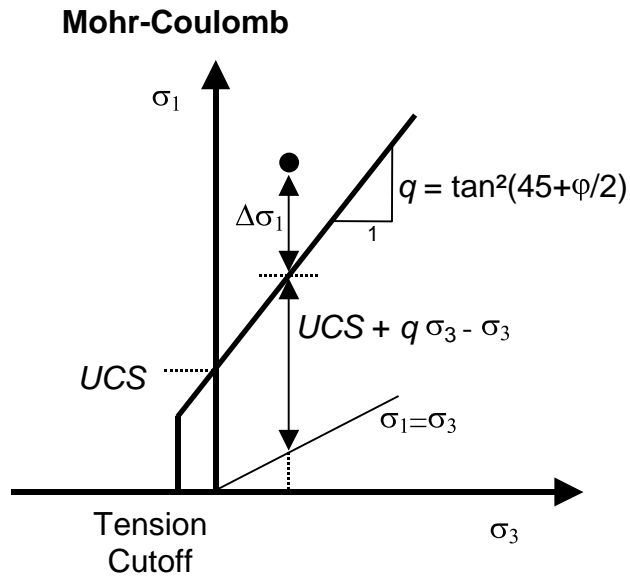

**SF-B** Plot > Strength Factors > SF-B Strength/Stress can be determined as  $(UCS + q \sigma_3 - \sigma_3) / (\sigma_1 - \sigma_3)$

**SF/B** Plot > Strength Factors > SF/B Strength/Stress can be determined as  $(\sigma_1 - \sigma_3) / (UCS + q \sigma_3 - \sigma_3)$

**Delta sigma\_1** Plot > Strength Factors >  $\Delta \sigma_1$  excess stress can be determined as  $\Delta \sigma_1 = \sigma_1 - (UCS + q \sigma_3)$

**N sigma\_1** Plot > Strength Factors >  $N(\Delta \sigma_1 / \text{std})$  Probability using the Normal distribution.

the same as in [method "A"](#).

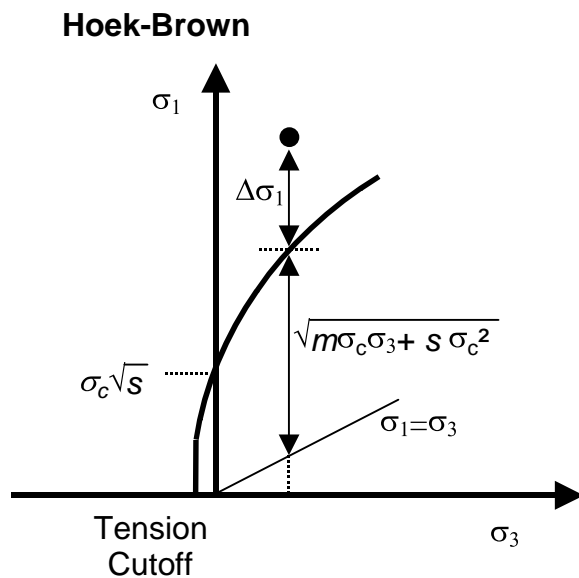



**SF-B** Plot > Strength Factors > SF-B Strength/Stress can be determined as  $\sqrt{(m \sigma_c \sigma_3 + s \sigma_c^2)} / (\sigma_1 - \sigma_3)$

3)

 [Plot > Strength Factors > SF/B](#) Strength/Stress can be determined as  $(\sigma_1 - \sigma_3) / \sqrt{(m \sigma_c \sigma_3 + s \sigma_c)}$

2)

 [Plot > Strength Factors > Δσ₁](#) excess stress can be determined as  $\Delta\sigma_1 = \sigma_1 - [\sigma_3 + \sqrt{(m \sigma_c \sigma_3 + s \sigma_c^2)}]$

 [Plot > Strength Factors > N\(Δσ₁/std\)](#) Probability using the Normal distribution.

the same as in [method "A"](#).

Drucker-Prager is only defined using [method "C"](#).

Strength parameters are setup using

 [Plot > Strength Factors > Strength Parameters](#)

Related topics:

 [Plot > Strength Factor > SF-A - Strength/Stress](#)

 [Plot > Strength Factors > SF-C - Strength/Stress](#)

 [Plot > Strength Factors > dTmax - Excess Stress](#)

 [Plot > Strength Factors > dToct - Excess Stress](#)

 [Plot > Strength Factors > In-plane Parameters](#)

 [Plot > Strength Factors > Ubiquitous Parameters](#)

#### 4.3.6.1.12 SF/C Stress/Strength

Contours the strength using method "C".

In elastic analysis the major and minor principal stresses can be used with the Mohr-Coulomb or Hoek-Brown strength criteria

 [Plot > Strength Factors > Strength Parameters](#)

to estimate the amount of damage due to over-stressing. Since none of the parameters have any orientation sensitivity, this criterion is representative for homogeneous rock mass stability.

By contrast, in non-linear analysis the stresses can never exceed the strength unless some creep is used. In this latter case, viscous creep can allow stress states above the failure criterion, thus indicating a lack of static equilibrium. Hence for non-linear analysis one normally directly considers the amount of non-linear strain or the strain rate predicted by the model

[Mohr-Coulomb in 3D FF blocks.](#)

Method "C" assumes that the stress path to failure takes place by increasing  $\sigma_1$  while loosing confinement. This is representative of an abutment failure where  $\sigma_1 - \sigma_3$  is considered to be the driving force.

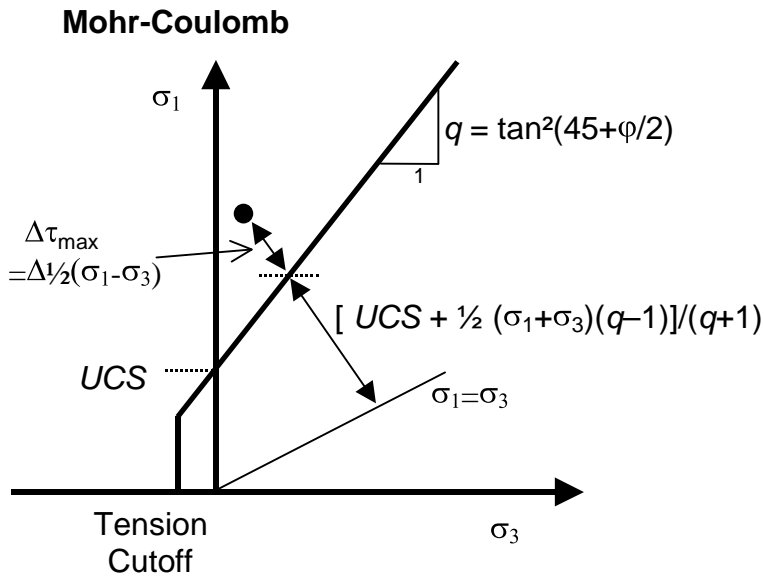

**SF-C** Plot > Strength Factors > SF-C Strength/Stress can be determined as  $[ UCS + \frac{1}{2}(\sigma_1 + \sigma_3)(q-1) ] / [ \frac{1}{2}(\sigma_1 - \sigma_3)(q+1) ]$

**SF/C** Plot > Strength Factors > SF/C Strength/Stress can be determined as  $[ \frac{1}{2}(\sigma_1 - \sigma_3)(q+1) ] / [ UCS + \frac{1}{2}(\sigma_1 + \sigma_3)(q-1) ]$

**$\Delta\tau_m$**  Plot > Strength Factors >  $\Delta\tau_{max}$  excess stress can be determined as

$$\Delta\tau_{max} = \frac{1}{2}(\sigma_1 - \sigma_3) - [ UCS + \frac{1}{2}(\sigma_1 + \sigma_3)(q-1) ] / (q+1)$$

$$= [ \sigma_1 - ( UCS + q \sigma_3 ) ] / (q+1)$$

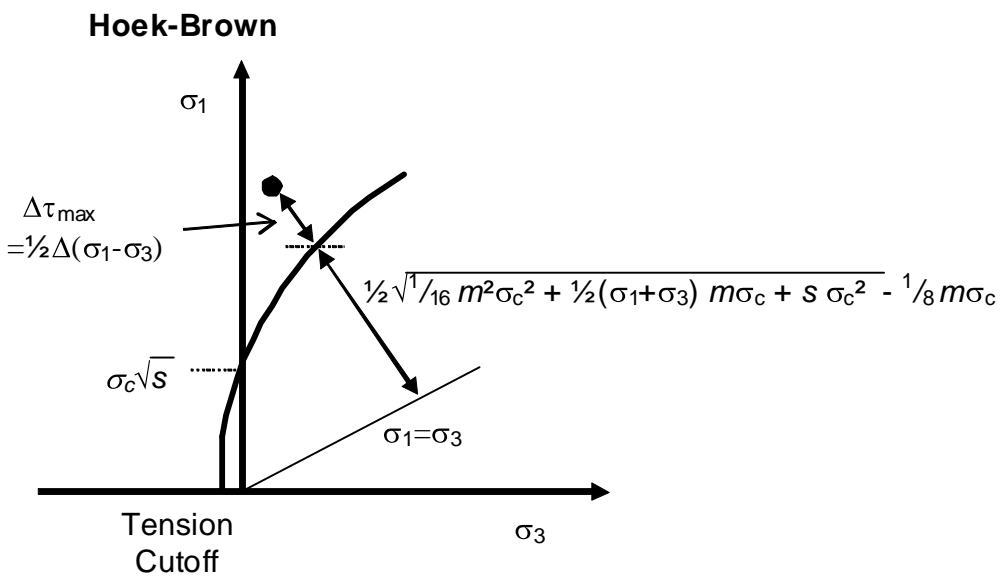

**SF-C** Plot > Strength Factors > SF-C Strength/Stress can be determined as  $\{ \sqrt{ \frac{1}{16} m^2 \sigma_c^2 + \frac{1}{2}(\sigma_1 + \sigma_3) m \sigma_c + s \sigma_c^2 } - \frac{1}{8} m \sigma_c \} / [ \frac{1}{2}(\sigma_1 - \sigma_3) ]$

$$\sigma_3) m\sigma_c + s\sigma_c^2] - \frac{1}{4} m\sigma_c / (\sigma_1 - \sigma_3)$$

**SF/C** Plot > Strength Factors > SF/C Strength/Stress can be determined as  $(\sigma_1 - \sigma_3) / \{ \sqrt{[ \frac{1}{16} m^2 \sigma_c^2 + \frac{1}{2} (\sigma_1 + \sigma_3) m\sigma_c + s\sigma_c^2 ] - \frac{1}{4} m\sigma_c} \}$

**$\Delta\tau_m$**  Plot > Strength Factors >  $\Delta\tau_{max}$  excess stress can be determined as

$$\Delta\tau_{max} = \frac{1}{2}(\sigma_1 - \sigma_3) - \frac{1}{2} \{ \sqrt{[ \frac{1}{16} m^2 \sigma_c^2 + \frac{1}{2} (\sigma_1 + \sigma_3) m\sigma_c + s\sigma_c^2 ] - \frac{1}{4} m\sigma_c} \}$$

### Drucker-Prager

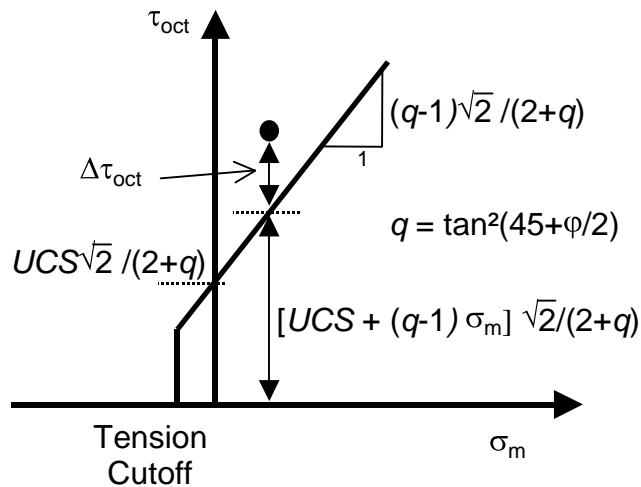

**SF-C** SF-C Strength/Stress can be determined as  $[ UCS + (q-1) \sigma_{mean} ] \sqrt{2} / [ \tau_{oct} (q+2) ]$

**SF/C** SF-C Stress/Strength can be determined as  $\tau_{oct} / [ UCS + (q-1) \sigma_{mean} ] \sqrt{2} / (q+2)$

**$\Delta\tau_{oct}$**  Dtoct Excess can be determined as  $\tau_{oct} - [ UCS + (q-1) \sigma_{mean} ] \sqrt{2} / (q+2)$

where

$$q = \tan^2(45 + \phi/2)$$

$$\tau_{oct} = \frac{1}{3} \sqrt{[(\sigma_1 - \sigma_2)^2 + (\sigma_2 - \sigma_3)^2 + (\sigma_3 - \sigma_1)^2]}$$

$$\sigma_{mean} = \frac{1}{3} (\sigma_1 + \sigma_2 + \sigma_3)$$

Note that the strength parameters have been chosen so that the criterion simplifies to the Mohr-Coulomb criterion when  $\sigma_2$  equals  $\sigma_3$ .

Strength parameters are setup using

**RM** [Plot > Strength Factors > Strength Parameters](#)

Related topics:

**SF-A** **SF/A** [Plot > Strength Factor > SF-A - Stress/Strength](#)

**SF-B** **SF/B** [Plot > Strength Factors > SF-B - Stress/Strength](#)

**$\Delta\sigma_1$**  [Plot > Strength Factors > dS1 - Excess Stress](#)

**IP** [Plot > Strength Factors > In-plane Parameters](#)

**UB** [Plot > Strength Factors > Ubiquitous Parameters](#)

### 4.3.6.2 In-Plane Parameters

#### 4.3.6.2.1 In-plane parameters

Sets up the strength parameters for generating strength factor contour plots in terms of in-plane stress components.

To calculate the in-plane shear and normal stresses, the stress state at each point on the grid plane is reoriented to determine the maximum shear stress parallel to the grid plane and the stress normal to the grid plane.

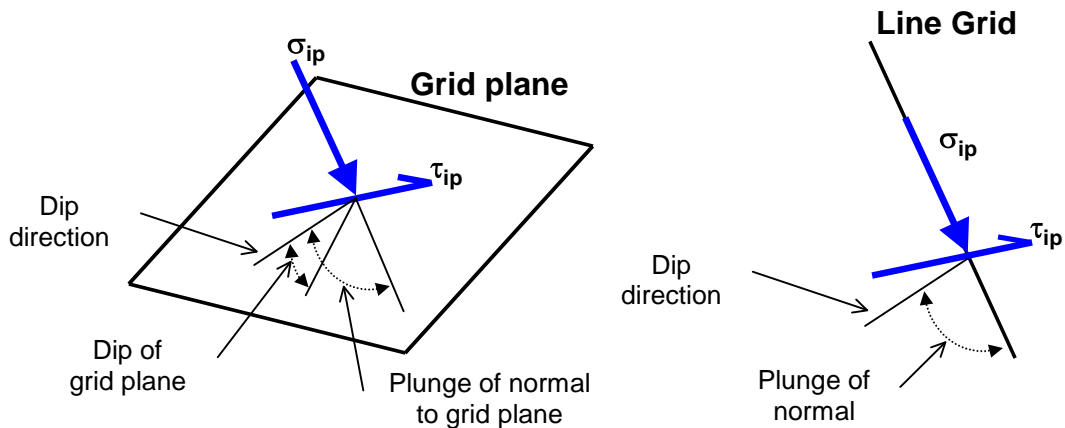

In elastic analysis the maximum in-plane shear and normal stresses can be used with the Mohr-Coulomb strength criterion to estimate the amount of slip due to over-stressing, on a fault, joint set or bedding plane oriented in the same way as the grid plane. Since these parameters are orientation dependant, this criterion is representative for anisotropic rock mass stability.

By contrast, in non-linear analysis the stresses can never exceed the strength unless some creep is used. In this latter case, viscous creep can allow stress states above the failure criterion, thus indicating a lack of static equilibrium. Hence for non-linear analysis one normally directly considers the amount of non-linear strain or the strain rate predicted by the model

[Mohr-Coulomb in DD planes](#)

[Fault-Gouge in DD planes](#)

[Backfill-Hyperbolic in DD planes](#)

In-plane Strength Paramet...	
Standard Dev	0
Tension	0
UCS (rockmass)	60
Cohesion	0
Friction angle	30
Slope	0.577350
? <input type="checkbox"/> Acc Dam	Apply OK

The Mohr-Coulomb criterion defines the shear strength in terms of shear stress and normal stress as follows:

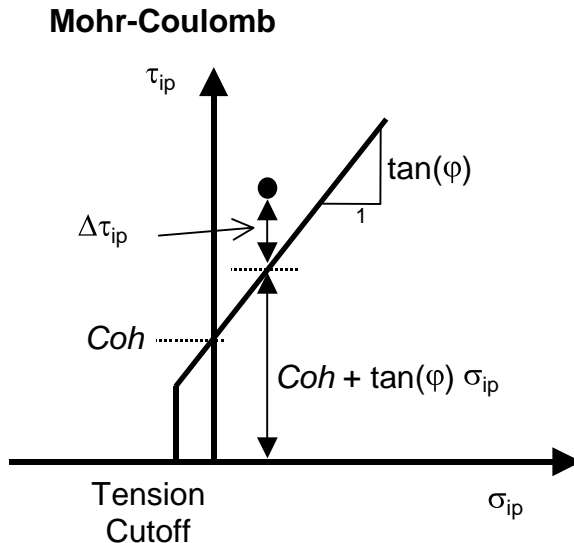

**Tension cutoff, UCS and Cohesion** are specified in units of stress (MPa or psi).







**Friction angle** is specified in degrees.

**Standard Deviation** specifies the uncertainty you have in the failure criterion measured in the  $\tau_{ip}$  direction (specified in units of stress, MPa or psi).

**Acc Dam** – plots accumulated damage. Refer to [Accumulated Damage](#)

**Apply** – regenerates the contour plot.

Related topics:

-  [Plot > Strength Factor > Probability N-distribution](#)
-  [Plot > Strength Factor > SF-ip - Stress/Strength](#)
-  [Plot > Strength Factors > SF-ub - Stress/Strength](#)
-  [Plot > Strength Factors > dTip - Excess Stress](#)
-  [Plot > Strength Factors > dTub - Excess Stress](#)
-  [Plot > Strength Factors > Rockmass Strength Parameters](#)
-  [Plot > Strength Factors > Ubiquitous Parameters](#)

#### 4.3.6.2.2 Accumulated Damage

Plot Accumulated Damage.

When not activated, the Excess Stress, Probability of Failure and Strength Factor are plotted for the current stress values.

When activated, damage is tracked from step 1 to the current step throughout the model loading history, and the worst case for Excess Stress, Probability of Failure or Strength Factor is plotted. This allows elastic stress analysis results to be used in a manner similar to accumulated strain in a plasticity model.



Damage tracking is done separately for the 5 following cases:

1. Rock Mass failure ([Excess S1 Stress, Probability, Strength Factor](#))
2. In-Plane Shear failure ([Excess Shear Stress, Probability, Strength Factor](#))
3. Ub-Plane Shear failure ([Excess Shear Stress, Probability, Strength Factor](#))
4. In-Plane Excess Wall Stress (Excess Stress, RCF)
5. Ub-Plane Excess Wall Stress (Excess Stress, RCF)

Note that both the step at which first yield occurs [MStep 1st Yield](#), and the step at which the maximum excess stress occurs [MStep Max Yield](#), are tracked and can be displayed as trajectory labels.

#### 4.3.6.2.3 In-plane Excess Shear Stress

Contours the strength for in-plane shear.

To calculate the in-plane shear and normal stresses, the stress state at each point on the grid plane is reoriented to determine the maximum shear stress parallel to the grid plane and the stress normal to the grid plane.

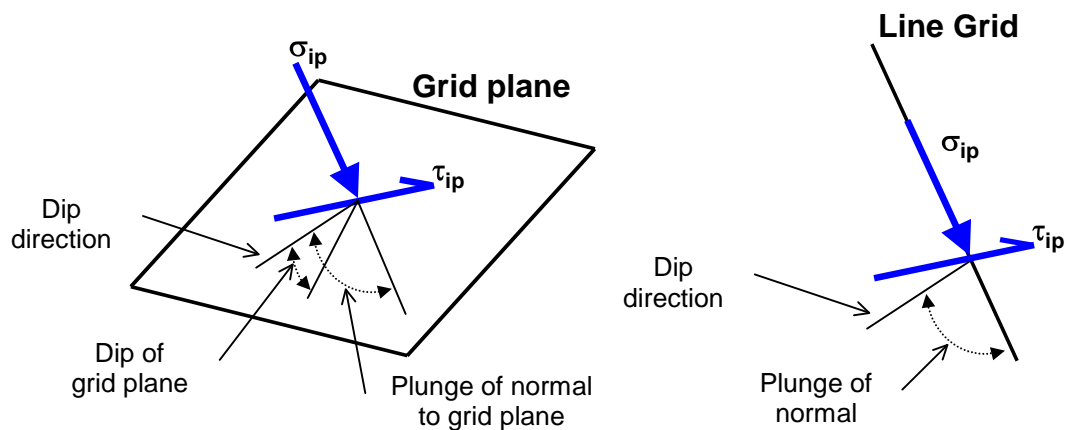

In elastic analysis the maximum in-plane shear and normal stresses can be used with the Mohr-Coulomb strength criterion

#### [Plot > Strength Factors > In-plane Parameters](#)

to estimate the amount of slip due to over-stressing, on a fault, joint set or bedding plane oriented in the same way as the grid plane. Since these parameters are orientation dependant, this criterion is representative for anisotropic rock mass stability.

By contrast, in non-linear analysis the stresses can never exceed the strength unless some creep is used. In this latter case, viscous creep can allow stress states above the failure criterion, thus indicating a lack of static equilibrium. Hence for non-linear analysis one normally directly considers the amount of non-linear strain or the strain rate predicted by the model

#### [Mohr-Coulomb in DD planes](#)

#### [Fault-Gouge in DD planes](#)

#### [Backfill-Hyperbolic in DD planes](#)

Here we assume that the stress path to failure takes place by increasing tip without losing

confinement.

### Mohr-Coulomb

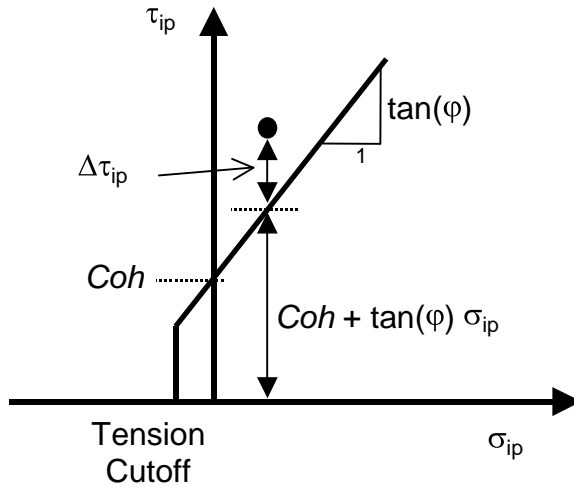

**SF<sub>ip</sub>** **SF-ip Strength/Stress** can be determined as  $[ Cohesion + \sigma_{ip} \tan(\varphi) ] / \tau_{ip}$

**SF<sub>ip</sub>** **SF-ip Stress/Strength** can be determined as  $\tau_{ip} / [ Cohesion + \sigma_{ip} \tan(\varphi) ]$

**Δτ<sub>ip</sub>** **dTip Excess** can be determined as  $\Delta\tau_{ip} = \tau_{ip} - [ Cohesion + \sigma_{ip} \tan(\varphi) ]$

**N<sub>τ<sub>ip</sub></sub>** **NTip Probability** can be determined as  $N(\Delta\tau_{ip} / \text{std})$

Strength parameters are set up using

**IP** [Plot > Strength Factors > In-plane Parameters](#)

Related topics:

**τ<sub>ip</sub>** [Plot > Stress > Tip - In-plane Shear](#)

**σ<sub>ip</sub>** [Plot > Stress > Sip - In-plane Normal](#)

**SF<sub>ub</sub>** **SF<sub>ub</sub>** [Plot > Strength Factors > SF-ub Strength/Stress](#)

**τ<sub>ub</sub>** [Plot > Strength Factors > dTub Excess](#)

**N<sub>τ<sub>ub</sub></sub>** [Plot > Strength Factors > NSub Probability](#)

#### 4.3.6.2.4 In-plane Excess Wall Stress

Contours the strength for in-plane wall stress.

To calculate the in-plane wall stress, the stress state at each point on the grid plane is reoriented to determine the maximum and minimum tangential stress parallel to the grid plane.

The maximum wall stress for a virtual circular excavation oriented perpendicular to the grid plane can then be determined as  $[ 3 \sigma_{1i} - \sigma_{3i} ]$ .

Note that  $\sigma_{ip}$  is oriented normal to the grid plane and parallel to the direction of a line grid. Also note that  $\sigma_{ip}$ ,  $\sigma_{1i}$  and  $\sigma_{3i}$  are perpendicular to one another.

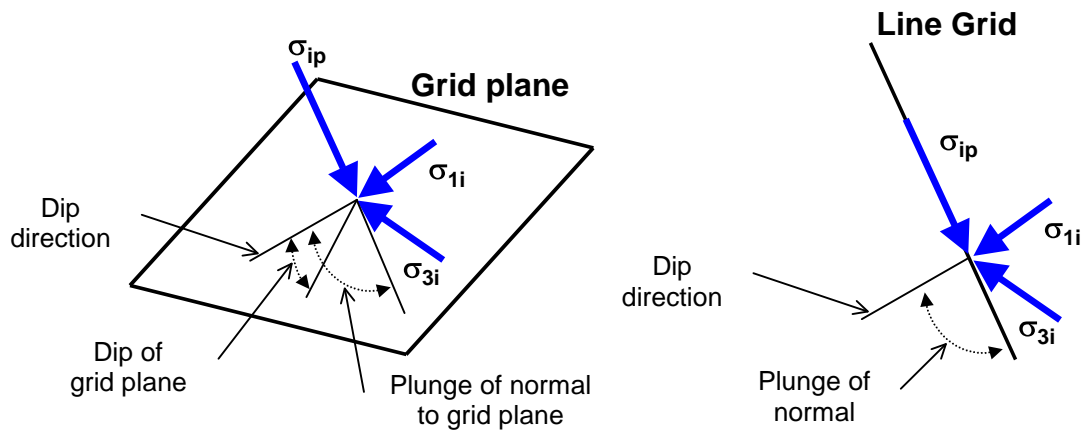

- **dip direction** is measured positive clockwise from the y-axis.
- **dip of the plane** is measured positive down from the horizontal (i.e. the dip direction).
- **plunge of the normal** is measured positive down (i.e. negative up) from the horizontal.

$\sigma_{ip}$  **dSip Excess** can be determined as  $\Delta\sigma_{ip} = [3\sigma_{1i} - \sigma_{3i}] - UCS$

$\sigma_{ip}$  **RCFip** can be determined as  $RCFip = [3\sigma_{1i} - \sigma_{3i}] / UCS$

Strength parameters are set up using

**IP** [Plot > Strength Factors > In-plane Parameters](#)

Related topics:

$\tau_{ip}$  [Plot > Stress > Tip - In-plane Shear](#)

$\sigma_{ip}$  [Plot > Stress > Sip - In-plane Normal](#)

$\sigma_{1i}$  [Plot > Stress > S1i - In-plane Maximum](#)

$\sigma_{3i}$  [Plot > Stress > S3i - In-plane Minimum](#)

$SF_{ub}$   $SF_{ub}$  [Plot > Strength Factors > SF-ub Strength/Stress](#)

$\tau_{ub}$  [Plot > Strength Factors > dTub Excess](#)

$\sigma_{ub}$  [Plot > Strength Factors > dSub Excess](#)

$N_{\tau_{ub}}$  [Plot > Strength Factors > NSub Probability](#)

#### 4.3.6.2.6 NTip Normal Probability

Contours the strength for in-plane shear.

To calculate the in-plane shear and normal stresses, the stress state at each point on the grid plane is reoriented to determine the maximum shear stress parallel to the grid plane and the stress normal to the grid plane.

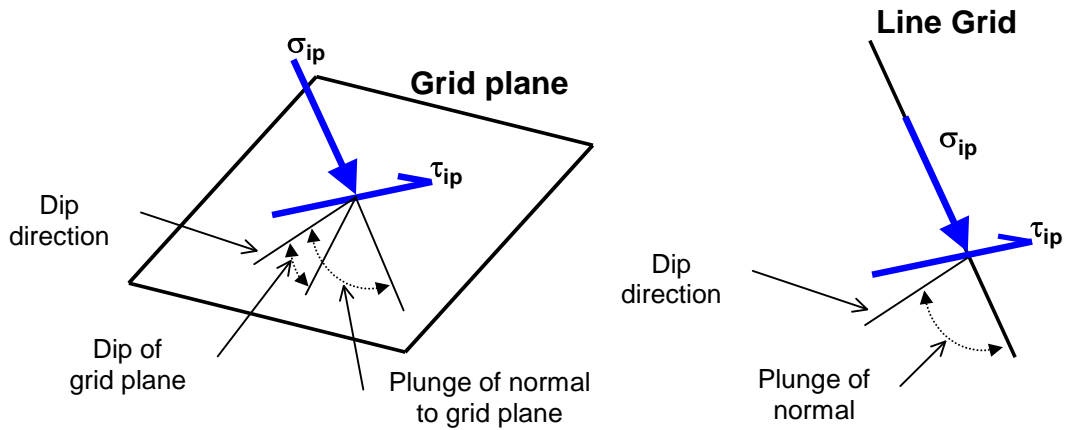

In elastic analysis the maximum in-plane shear and normal stresses can be used with the Mohr-Coulomb strength criterion

**IP** [Plot > Strength Factors > In-plane Parameters](#)

to estimate the amount of slip due to over-stressing, on a fault, joint set or bedding plane oriented in the same way as the grid plane. Since these parameters are orientation dependant, this criterion is representative for anisotropic rock mass stability.

By contrast, in non-linear analysis the stresses can never exceed the strength unless some creep is used. In this latter case, viscous creep can allow stress states above the failure criterion, thus indicating a lack of static equilibrium. Hence for non-linear analysis one normally directly considers the amount of non-linear strain or the strain rate predicted by the model

[Mohr-Coulomb in DD planes](#)

[Fault-Gouge in DD planes](#)

[Backfill-Hyperbolic in DD planes](#)

Here we assume that the stress path to failure takes place by increasing tip without losing confinement.

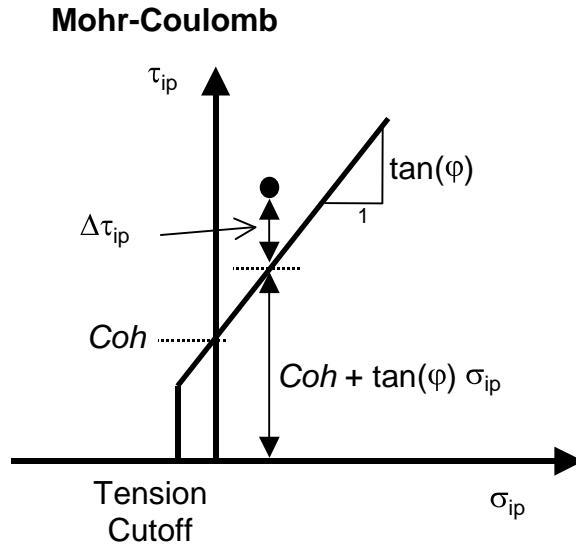

**SF<sub>ip</sub>** **SF-ip Strength/Stress** can be determined as  $[ \text{Cohesion} + \sigma_{ip} \tan(\varphi) ] / \tau_{ip}$

**SF<sub>ip</sub>** **SF-ip Stress/Strength** can be determined as  $\tau_{ip} / [ \text{Cohesion} + \sigma_{ip} \tan(\varphi) ]$

**Δτ<sub>ip</sub>** **dTip Excess** can be determined as  $\Delta\tau_{ip} = \tau_{ip} - [ \text{Cohesion} + \sigma_{ip} \tan(\varphi) ]$

**Nτ<sub>ip</sub>** **NTip Probability** can be determined as  $N(\Delta\tau_{ip} / \text{std})$

Strength parameters are set up using

**IP** [Plot > Strength Factors > In-plane Parameters](#)

Related topics:

**τ<sub>ip</sub>** [Plot > Stress > Tip - In-plane Shear](#)

**σ<sub>ip</sub>** [Plot > Stress > Sip - In-plane Normal](#)

**SF<sub>ub</sub>** **SF/ub** [Plot > Strength Factors > SF-ub Strength/Stress](#)

**τ<sub>ub</sub>** [Plot > Strength Factors > dTub Excess](#)

**Nτ<sub>ub</sub>** [Plot > Strength Factors > NSub Probability](#)

### 4.3.6.3 UB-Plane Parameters

#### 4.3.6.3.1 Ubiquitous parameters

Sets up the strength parameters for generating strength factor contour plots in terms of ubiquitous-plane stress components.

To calculate the ubiquitous shear and normal stresses, the stress state at each point on the grid plane is reoriented to determine the maximum shear stress parallel to the ubiquitous shear plane and the stress normal to the ubiquitous shear plane.

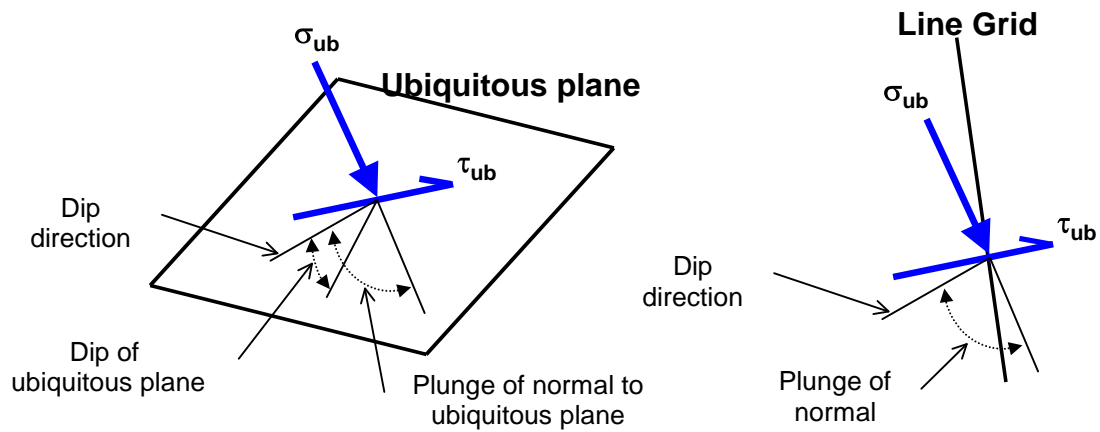

In elastic analysis the maximum ubiquitous-plane shear and normal stresses can be used with the Mohr-Coulomb strength criterion to estimate the amount of slip due to over-stressing, on a fault, joint set or bedding plane at the specified orientation. Since these parameters are orientation dependant, this criterion is representative for anisotropic rock mass stability.

By contrast, in non-linear analysis the stresses can never exceed the strength unless some creep is used. In this latter case, viscous creep can allow stress states above the failure criterion, thus indicating a lack of static equilibrium. Hence for non-linear analysis one normally directly considers the amount of non-linear strain or the strain rate predicted by the model

[Mohr-Coulomb in DD planes](#)

[Fault-Gouge in DD planes](#)

[Backfill-Hyperbolic in DD planes](#)

Ubiquitous-plane Strength Parameters			
Standard Dev	0		
Tension	0		
UCS (rockmass)	60	<input type="checkbox"/> UB#2	<input type="checkbox"/> UB#3
Cohesion	0	0	0
Friction angle	30	28	25
Slope	0.577350	0.531710	0.466310
Dip of plane	0	30	60
Dip direction	0	90	90
Plunge of normal	90	-60.000000	-30.000000
? Grid Normal	dip 90, dir 180	<input type="checkbox"/> Acc Damage	Apply OK

**Cohesion and Friction Angle** the Mohr-Coulomb criterion defines strength in terms of principal stresses as follows:

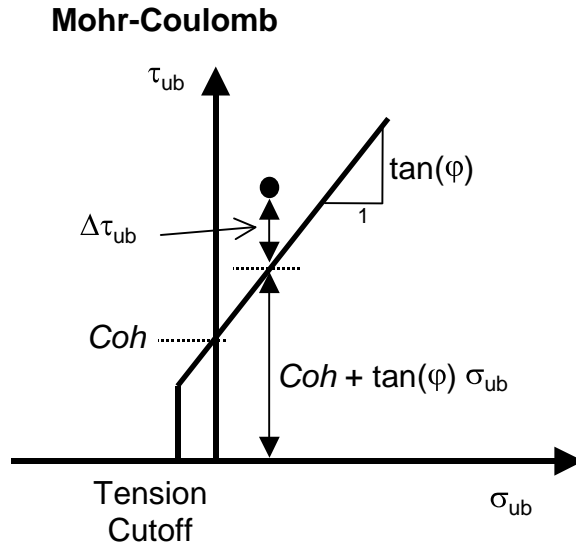

**Tension cutoff, UCS and Cohesion** are specified in units of stress (MPa or psi). Friction angle is specified in degrees.

**Standard Deviation** specifies the uncertainty you have in the failure criterion measured in the  $\tau_{ip}$  direction (specified in units of stress, MPa or psi).

**Dip of plane** – specifies the dip of the ubiquitous plane (in degrees). The dip of the normal is automatically adjusted to reflect changes in this value.

**Dip Direction** – specifies the dip direction of the ubiquitous plane (in degrees).

**Dip of Normal** – specifies the dip of the normal to the ubiquitous plane (in degrees). The dip of plane is automatically adjusted to reflect changes in this value.

**Grid Normal** – sets the ubiquitous plane parallel to the currently selected grid plane. In this case all in-plane results will be identical to the ubiquitous plane results.

**Acc Dam** – plots accumulated damage. Refer to [Accumulated Damage](#)

**Apply** – regenerates the contour plot.

**UB#2 & UB#3** – activates strength parameters for ubiquitous plane #2 and/or #3. When checked, the minimum for all active ubiquitous planes is presented for all strength parameters ([N<sub>ub</sub>](#) [Plot > Strength Factor > Probability N-distribution](#), [SF-ub](#) [SF/ub](#) [Plot > Strength Factors > SF-ub - Stress/Strength](#) and [tau<sub>ub</sub>](#) [Plot > Strength Factors > dTub - Excess Stress](#)). To determine which ubiquitous plane has the minimum strength you can plot [delta tau<sub>ip</sub>](#) [Plot > Strength Factors > UB# with minimum strength](#) or left click on and strength parameter plot.

Related topics:

- [N<sub>ub</sub>](#) [Plot > Strength Factor > Probability N-distribution](#)
- [SF-ub](#) [SF/ub](#) [Plot > Strength Factors > SF-ub - Stress/Strength](#)
- [SF-ip](#) [SF/ip](#) [Plot > Strength Factor > SF-ip - Stress/Strength](#)
- [tau<sub>ub</sub>](#) [Plot > Strength Factors > dTub - Excess Stress](#)
- [delta tau<sub>ip</sub>](#) [Plot > Strength Factors > dTip - Excess Stress](#)
- [delta tau<sub>ip</sub>](#) [Plot > Strength Factors > UB# with minimum strength](#)
- [RM](#) [Plot > Strength Factors > Rockmass Strength Parameters](#)
- [IP](#) [Plot > Strength Factors > In-plane Parameters](#)

## 4.3.6.3.2 Accumulated Damage

Plot Accumulated Damage.

When not activated, the Excess Stress, Probability of Failure and Strength Factor are plotted for the current stress values.

When activated, damage is tracked from step 1 to the current step throughout the model loading history, and the worst case for Excess Stress, Probability of Failure or Strength Factor is plotted. This allows elastic stress analysis results to be used in a manner similar to accumulated strain in a plasticity model.

Damage tracking is done separately for the 5 following cases:

1. Rock Mass failure ([Excess S1 Stress, Probability, Strength Factor](#))
2. In-Plane Shear failure ([Excess Shear Stress, Probability, Strength Factor](#))
3. Ub-Plane Shear failure ([Excess Shear Stress, Probability, Strength Factor](#))
4. In-Plane Excess Wall Stress (Excess Stress, RCF)
5. Ub-Plane Excess Wall Stress (Excess Stress, RCF)

Note that both the step at which first yield occurs [MStep 1st Yield](#), and the step at which the maximum excess stress occurs [MStep Max Yield](#), are tracked and can be displayed as trajectory labels.

## 4.3.6.3.3 Ubiquitous Excess Shear Stress

Contours the strength for ubiquitous-plane shear.

To calculate the ubiquitous shear and normal stresses, the stress state at each point on the grid plane is reoriented to determine the maximum shear stress parallel to the ubiquitous shear plane and the stress normal to the ubiquitous shear plane.

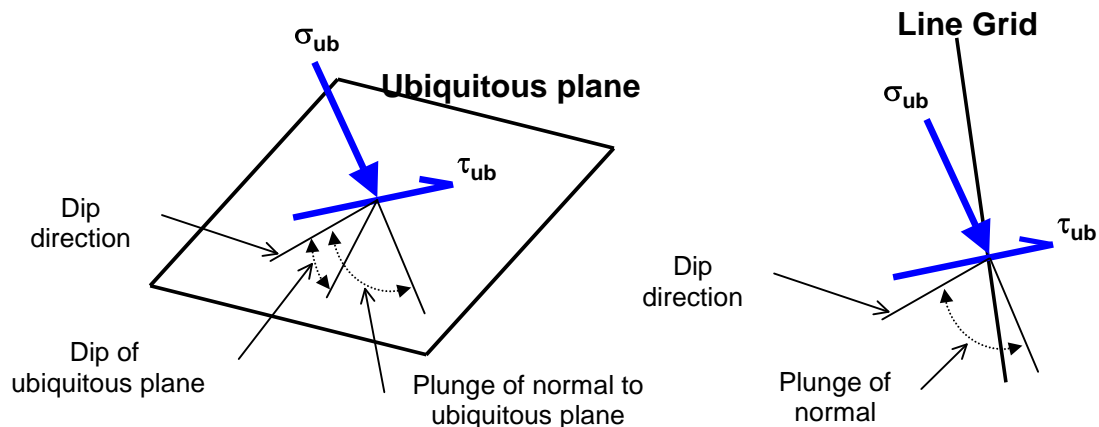

The orientation of the ubiquitous shear plane is set using

 [Plot > Strength Factors > Ubiquitous Parameters](#)

In elastic analysis the maximum ubiquitous-plane shear and normal stress can be used with the Mohr-Coulomb strength criterion to estimate the amount of slip due to over-stressing, on a fault, joint



set or bedding plane at the specified orientation. Since these parameters are orientation dependant, this criterion is representative for anisotropic rock mass stability.

By contrast, in non-linear analysis the stresses can never exceed the strength unless some creep is used. In this latter case, viscous creep can allow stress states above the failure criterion, thus indicating a lack of static equilibrium. Hence for non-linear analysis one normally directly considers the amount of non-linear strain or the strain rate predicted by the model

[Mohr-Coulomb in DD planes](#)

[Fault-Gouge in DD planes](#)

[Backfill-Hyperbolic in DD planes](#)

Here we assume that the stress path to failure takes place by increasing tub without losing confinement.

### Mohr-Coulomb

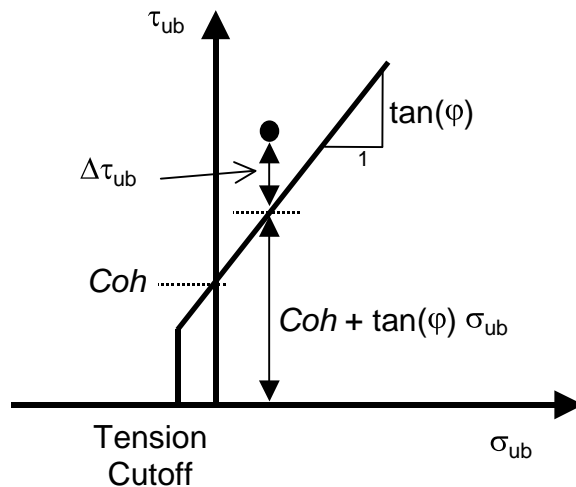

$SF_{ub}$  **SF-ub Strength/Stress** can be determined as  $[ Cohesion + \sigma_{ub} \tan(\varphi) ] / \tau_{ub}$

$SF_{ub}$  **SF-ub Stress/Strength** can be determined as  $\tau_{ub} / [ Cohesion + \sigma_{ub} \tan(\varphi) ]$

$\tau_{ub}$  **dTub Excess** can be determined as  $\Delta\tau_{ub} = \tau_{ub} - [ Cohesion + \sigma_{ub} \tan(\varphi) ]$

$N_{\tau_{ub}}$  **NTub Probability** can be determined as  $N(\Delta\tau_{ub}/std)$

Strength parameters are set up using

**UB** [Plot > Strength Factors > Ubiquitous Parameters](#)

Related topics:

$\tau_{ub}$  [Plot > Stress > Tub - Ubiquitous-plane Shear](#)

$\sigma_{ub}$  [Plot > Stress > Sub - Ubiquitous-plane Normal](#)

$\sigma_{1u}$  [Plot > Stress > S1u - Ubiquitous-plane Maximum](#)





$\sigma_{3u}$  [Plot > Stress > S3u - Ubiquitous-plane Minimum](#)

$SF_{ip}$   $SF_{ip}$  [Plot > Strength Factors > SF-ub Strength/Stress](#)

 [Plot > Strength Factors > dTip Excess](#)

 [Plot > Strength Factors > dSip Excess](#)

 [Plot > Strength Factors > NTip Probability](#)

**UB#2 & UB#3** – activates strength parameters for ubiquitous plane #2 and/or #3. When checked, the minimum for all active ubiquitous planes is presented for all strength parameters ( [Plot > Strength Factor > Probability N-distribution](#),   [Plot > Strength Factors > SF-ub - Stress/Strength](#) and  [Plot > Strength Factors > dTub - Excess Stress](#)). To determine which ubiquitous plane has the minimum strength you can plot  [Plot > Strength Factors > UB# with minimum strength](#) or left click on and strength parameter plot.

#### 4.3.6.3.4 Ubiquitous Plane Excess Wall Stress

Contours the strength for ub-plane wall stress.

To calculate the ub-plane wall stress, the stress state at each point on the grid plane is reoriented to determine the maximum and minimum tangential stress parallel to the ub plane.

The maximum wall stress for a virtual circular excavation oriented perpendicular to the ub-plane can then be determined as  $[3\sigma_{1u} - \sigma_{3u}]$ .

Note that  $\sigma_{ub}$  is oriented normal to the ub-plane. Also note that  $\sigma_{ub}$ ,  $\sigma_{1u}$  and  $\sigma_{3u}$  are perpendicular to one another.

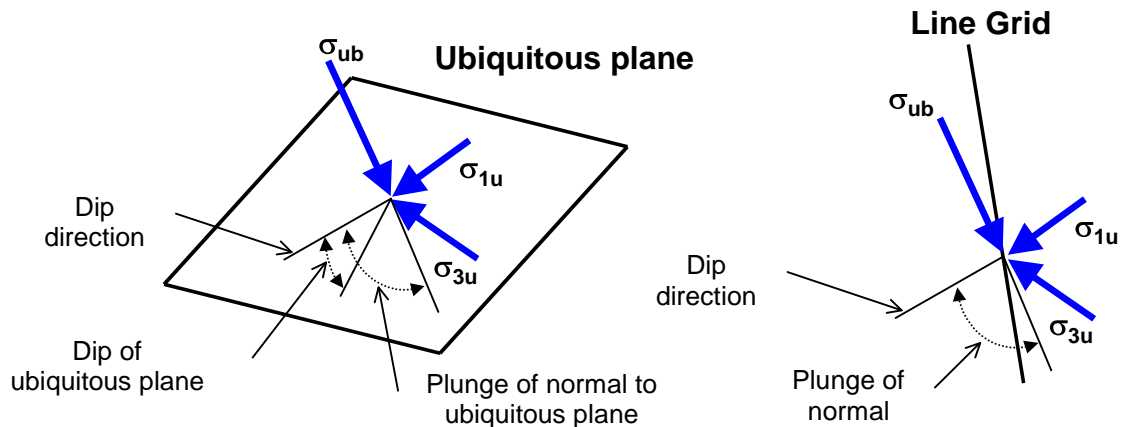

- **dip direction** is measured positive clockwise from the y-axis.
- **dip of the plane** is measured positive down from the horizontal (i.e. the dip direction).
- **plunge of the normal** is measured positive down (i.e. negative up) from the horizontal.









 [dSub Excess](#) can be determined as  $\Delta\sigma_{ub} = [3\sigma_{1u} - \sigma_{3u}] - UCS$

 [RCFub](#) can be determined as  $RCFub = [3\sigma_{1u} - \sigma_{3u}]/UCS$

The orientation of the ubiquitous shear plane is set using

 [Plot > Strength Factors > Ubiquitous Parameters](#)

Related topics:

-  [Plot > Stress > Tub - Ubiquitous-plane Shear](#)
-  [Plot > Stress > Sub - Ubiquitous-plane Normal](#)
-  [Plot > Stress > S1u - Ubiquitous-plane Maximum](#)
-  [Plot > Stress > S3u - Ubiquitous-plane Minimum](#)
-   [Plot > Strength Factors > SF-ub Strength/Stress](#)
-  [Plot > Strength Factors > dTip Excess](#)
-  [Plot > Strength Factors > dSip Excess](#)
-  [Plot > Strength Factors > NTip Probability](#)

#### 4.3.6.3.6 NTub Normal Probability

Contours the strength for ubiquitous-plane shear.

To calculate the ubiquitous shear and normal stresses, the stress state at each point on the grid plane is reoriented to determine the maximum shear stress parallel to the ubiquitous shear plane and the stress normal to the ubiquitous shear plane.

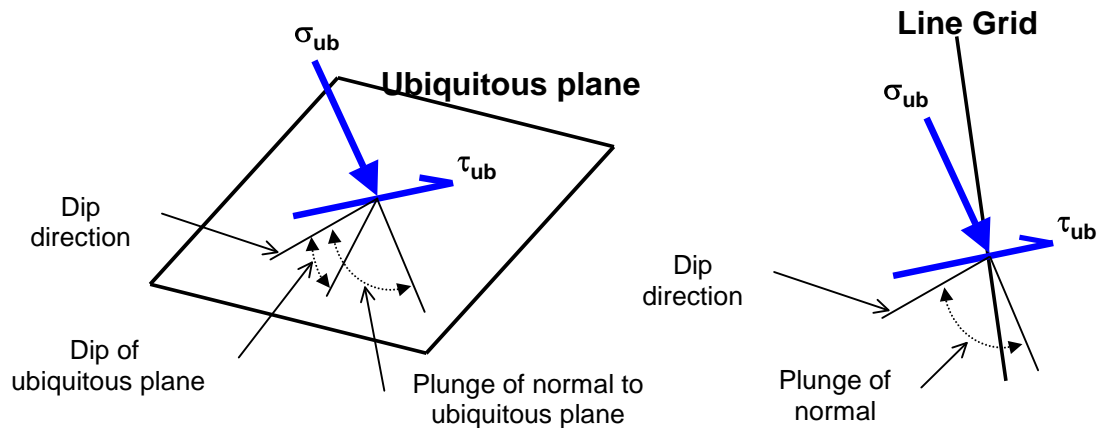

The orientation of the ubiquitous shear plane is set using

-  [Plot > Strength Factors > Ubiquitous Parameters](#)

In elastic analysis the maximum ubiquitous-plane shear and normal stress can be used with the Mohr-Coulomb strength criterion to estimate the amount of slip due to over-stressing, on a fault, joint set or bedding plane at the specified orientation. Since these parameters are orientation dependant, this criterion is representative for anisotropic rock mass stability.

By contrast, in non-linear analysis the stresses can never exceed the strength unless some creep is used. In this latter case, viscous creep can allow stress states above the failure criterion, thus indicating a lack of static equilibrium. Hence for non-linear analysis one normally directly considers the amount of non-linear strain or the strain rate predicted by the model

[Mohr-Coulomb in DD planes](#)

[Fault-Gouge in DD planes](#)

### [Backfill-Hyperbolic in DD planes](#)

Here we assume that the stress path to failure takes place by increasing tub without losing confinement.

#### Mohr-Coulomb

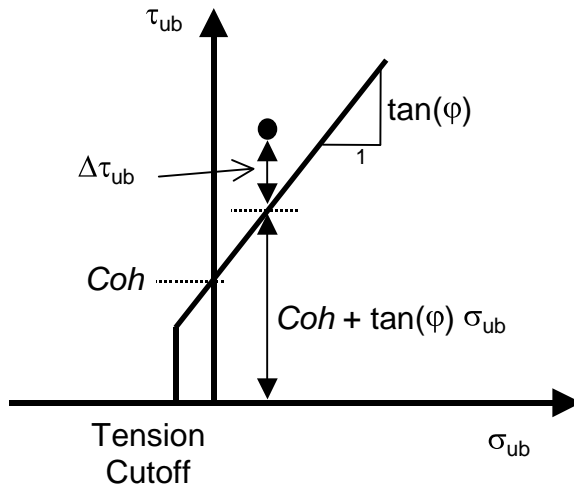

$\text{SF}_{ub}$  **SF-ub Strength/Stress** can be determined as  $[ \text{Cohesion} + \sigma_{ub} \tan(\varphi) ] / \tau_{ub}$

$\text{SF}_{ub}$  **SF-ub Stress/Strength** can be determined as  $\tau_{ub} / [ \text{Cohesion} + \sigma_{ub} \tan(\varphi) ]$

$\tau_{ub}$  **dTub Excess** can be determined as  $\Delta\tau_{ub} = \tau_{ub} - [ \text{Cohesion} + \sigma_{ub} \tan(\varphi) ]$

$N_{\tau_{ub}}$  **NTub Probability** can be determined as  $N(\Delta\tau_{ub} / \text{std})$

Strength parameters are set up using

**UB** [Plot > Strength Factors > Ubiquitous Parameters](#)

Related topics:

$\tau_{ub}$  [Plot > Stress > Tub - Ubiquitous-plane Shear](#)

$\sigma_{ub}$  [Plot > Stress > Sub - Ubiquitous-plane Normal](#)

$\sigma_{1u}$  [Plot > Stress > S1u - Ubiquitous-plane Maximum](#)

$\sigma_{3u}$  [Plot > Stress > S3u - Ubiquitous-plane Minimum](#)

$\text{SF}_{ip}$   $\text{SF}_{ip}$  [Plot > Strength Factors > SF-ub Strength/Stress](#)

$\Delta\tau_{ip}$  [Plot > Strength Factors > dTip Excess](#)

$\Delta\sigma_{ip}$  [Plot > Strength Factors > dSip Excess](#)

$N_{\tau_{ip}}$  [Plot > Strength Factors > NTip Probability](#)

**UB#2 & UB#3** – activates strength parameters for ubiquitous plane #2 and/or #3. When checked, the minimum for all active ubiquitous planes is presented for all strength parameters ( $N_{\tau_{ub}}$  [Plot > Strength Factor > Probability N-distribution](#),  $\text{SF}_{ub}$   $\text{SF}_{ub}$  [Plot > Strength Factors > SF-ub - Stress/Strength](#) and  $\tau_{ub}$  [Plot > Strength Factors > dTub - Excess Stress](#)). To determine which ubiquitous plane has the minimum strength you can plot  $\Delta\tau_{ip}$  [Plot > Strength Factors > UB# with minimum strength](#)) or left click

on and strength parameter plot.

### 4.3.7 Surface Components

#### 4.3.7.1 Surface Contours Off

Turns the contours off.

#### 4.3.7.2 Serr Stress error

Contours the surface stress error.

During matrix solution Map3D is attempting to progressively solve the simultaneous equations saved in the coefficient matrix along with any other equations describing the alternate material zones, fault slip, creep etc. The iterative solver functions by determining the error in the current solution of each simultaneous equation (the surface stress error), then reducing these errors by a process of successive approximations.

A converged solution is assumed to have been obtained when the maximum surface stress error and the maximum failure criterion error are reduced below the user specified stress tolerance **STOL**

[Analysis > CParams](#)

#### Related Topics:

 [Plot > Surface Components > Ferr - Failure Error](#)

[Analysis Dialog](#)

#### 4.3.7.3 Ferr Failure error

Contours the surface failure criterion error.

During matrix solution Map3D is attempting to progressively solve the simultaneous equations saved in the coefficient matrix along with any other equations describing the alternate material zones, fault slip, creep etc. The iterative solver functions by determining the error in the current solution of each simultaneous equation (the surface stress error), then reducing these errors by a process of successive approximations.

A converged solution is assumed to have been obtained when the maximum surface stress error and the maximum failure criterion error are reduced below the user specified stress tolerance **STOL**

[Analysis > CParams](#)

The failure criterion error is only used for non-linear creep analyses (including fault slip and 3D material non-linearity). This parameter should always be near zero unless some viscosity has been specified and the problem goes non-linear. In this latter case, viscous creep can allow stress states above the failure criterion, thus indicating a lack of static equilibrium.

#### Related Topics:

 [Plot > Surface Components > Serr - Stress Error](#)

[Analysis > Options > Creep](#)

[Analysis Dialog](#)

#### 4.3.7.4 Shear stress

Contours the maximum shear stress in the plane of the surface.

In elastic analysis the maximum in-plane shear stress is normally used with the in-plane normal stress and the Mohr-Coulomb strength criterion to estimate the amount of slip due to over-stressing, on a fault, joint set or bedding plane.

By contrast, in non-linear analysis the maximum in-plane shear stress can never exceed the strength unless some creep is used. In this latter case, viscous creep can allow stress states above the failure criterion, thus indicating a lack of static equilibrium. Hence for non-linear analysis one normally directly considers the amount of slip predicted by the model

[Mohr-Coulomb in DD planes](#)

[Fault-Gouge in DD planes](#)

[Backfill-Hyperbolic in DD planes](#)

The contour range is set using

 [Plot > Range](#)

This component can be added to the contour toolbar if desired

 [Tools > Configure Contouring Toolbar](#)

#### Related Topics:

 [Plot > Surface Components > Sn - Normal Stress](#)

 [Plot > Surface Components > dTs - Excess Shear Stress](#)

 [Plot > Surface Components > dEs - Incremental Shear Strain](#)

 [Plot > Surface Components > Es - Shear Strain](#)

 [Plot > Surface Components > ds - Shear Displacement \(Ride\)](#)

#### 4.3.7.5 Normal stress

Contours the stress normal to the surface.

In elastic analysis the maximum in-plane shear stress is normally used with the in-plane normal stress and the Mohr-Coulomb strength criterion to estimate the amount of slip due to over-stressing, on a fault, joint set or bedding plane.

By contrast, in non-linear analysis the maximum in-plane shear stress can never exceed the strength unless some creep is used. In this latter case, viscous creep can allow stress states above the failure criterion, thus indicating a lack of static equilibrium. Hence for non-linear analysis one normally directly considers the amount of slip predicted by the model

[Mohr-Coulomb in DD planes](#)

[Fault-Gouge in DD planes](#)

[Backfill-Hyperbolic in DD planes](#)





The contour range is set using

 [Plot > Range](#)

This component can be added to the contour toolbar if desired

 [Tools > Configure Contouring Toolbar](#)

**Related Topics:**

-  [Plot > Surface Components > Ts - Shear Stress](#)
-  [Plot > Surface Components > dTs - Excess Shear Stress](#)
-  [Plot > Surface Components > dEs - Incremental Shear Strain](#)
-  [Plot > Surface Components > Es - Shear Strain](#)
-  [Plot > Surface Components > ds - Shear Displacement \(Ride\)](#)



**4.3.7.6 Shear strain**

Contours the shear strain occurring in the in-filling material of DD elements.



The shear strain is determined by dividing the shear displacement (ride) by the DDplane thickness.

 [CAD > Edit > Entity Properties > DDplane Thickness](#)

Note that there are three components of strain that can be contoured:

-  [Plot > Surface Components > Value > Elastic](#)
-  [Plot > Surface Components > Value > Plastic](#)
-  [Plot > Surface Components > Value > Total](#)

There are also two different ways of presenting the strain:

-  [Plot > Strain > Value > Induced Strain](#)
-  [Plot > Strain > Value > Absolute Strain](#)

Note that  $\epsilon_s$  is the current level of shear strain acting on the DD surfaces.

Since the displacement can change direction and even reverse during slip, the total accumulated shear strain  $\epsilon_{acc}$  can give different values.

The contour range is set using

 [Plot > Range](#)

This component can be added to the contour toolbar if desired

 [Tools > Configure Contouring Toolbar](#)

**Related Topics:**

-  [Plot > Surface Components > dEs - Incremental Shear Strain](#)
-  [Plot > Surface Components > ds - Shear Displacement \(Ride\)](#)

**4.3.7.8 Normal strain**

Contours the normal strain occurring in the in-filling material of DD elements.

The normal strain is determined by dividing the normal displacement (closure) by the DDplane thickness

 [CAD > Edit > Entity Properties > DDplane Thickness](#)

Note that there are three components of strain that can be contoured:

 [Plot > Surface Components > Value > Elastic](#)

 [Plot > Surface Components > Value > Plastic](#)

 [Plot > Surface Components > Value > Total](#)

The contour range is set using

 [Plot > Range](#)

This component can be added to the contour toolbar if desired

 [Tools > Configure Contouring Toolbar](#)

#### Related Topics:

 [Plot > Surface Components > dn - Normal Displacement \(Closure\)](#)

#### 4.3.7.9 Shear Displacement (Ride)

Contours the ride or shear displacement occurring on DD elements.

Note that there are three components of shear displacement that can be contoured:

 [Plot > Surface Components > Value > Elastic](#)

 [Plot > Surface Components > Value > Plastic](#)

 [Plot > Surface Components > Value > Total](#)

There are also two different ways of presenting the displacement:

 [Plot > Strain > Value > Induced Strain](#)

 [Plot > Strain > Value > Absolute Strain](#)

The contour range is set using

 [Plot > Range](#)

This component can be added to the contour toolbar if desired

 [Tools > Configure Contouring Toolbar](#)

#### Related Topics:

 [Plot > Surface Components > dEs - Incremental Shear Strain](#)

 [Plot > Surface Components > Es - Shear Strain](#)

#### 4.3.7.10 Normal Displacement (Closure)

Contours the closure or normal displacement occurring on DD elements.

Note that there are three components of closure that can be contoured:

 [Plot > Surface Components > Value > Elastic](#)

 [Plot > Surface Components > Value > Plastic](#)

 [Plot > Surface Components > Value > Total](#)



The contour range is set using

 [Plot > Range](#)

This component can be added to the contour toolbar if desired

 [Tools > Configure Contouring Toolbar](#)

#### Related Topics:

 [Plot > Surface Components > ds - Shear Displacement \(Ride\)](#)

### 4.3.7.11 ERR

Calculate energy release rate.

This routine enables the user to calculate energy release rate (*ERR*) ahead of an excavation face. An alternative method is available where *ERR* can be calculated at any desired location [Analysis > Options > LERD/LSS](#)

#### Crack-tip Formulation

Consider a planar crack in an infinite homogeneous elastic medium. It is well known that near the crack tip, the aperture  $\delta$  exhibits a  $\sqrt{r}$  response near the face

$$\delta = p_{\delta} \sqrt{r} \quad [1]$$

and the stress  $\sigma$  exhibits a  $1/\sqrt{r}$  response

$$\sigma = p_{\sigma} / \sqrt{r} \quad [2]$$

where  $r$  represents the distance from the crack tip.

The total energy released can be determined for a small increment of face advance  $\alpha$  by superimposing the normal displacement (closure) with the stress over the region  $\alpha$ . This requires that we offset the coordinate system for  $\delta$  by the distance  $\alpha$  giving

$$\delta = p_{\delta} \sqrt{(\alpha-r)} \quad [3]$$

The total energy released can then be calculated from (the integral is taken from 0 to  $\alpha$ )

$$\begin{aligned} W &= \frac{1}{2} \int \sigma \delta \, dr \\ &= \frac{1}{2} p_{\delta} p_{\sigma} \int \sqrt{(\alpha-r)} / \sqrt{r} \, dr \\ &= \frac{1}{4} \pi \alpha p_{\delta} p_{\sigma} \end{aligned} \quad [4]$$

The energy release rate can now be determined by differentiating by  $\alpha$  to arrive at

$$ERR = \frac{1}{4} \pi p_{\delta} p_{\sigma} \quad [5]$$

This expression has only made the assumption that  $\delta$  exhibits a  $\sqrt{r}$  response near the face and that  $\sigma$  exhibits a  $1/\sqrt{r}$  response near the face. No assumptions regarding the geometry have been made. There is no requirement for  $p_{\delta}$  to be related to  $p_{\sigma}$  in any way. Note that these assumptions are only true in an infinite homogeneous elastic medium. Near bi-material interfaces or other excavation

surfaces these assumptions break down.

### Analytical Solution for a Planar Crack

Consider a planar crack with width  $2c$  and length eight times the width.

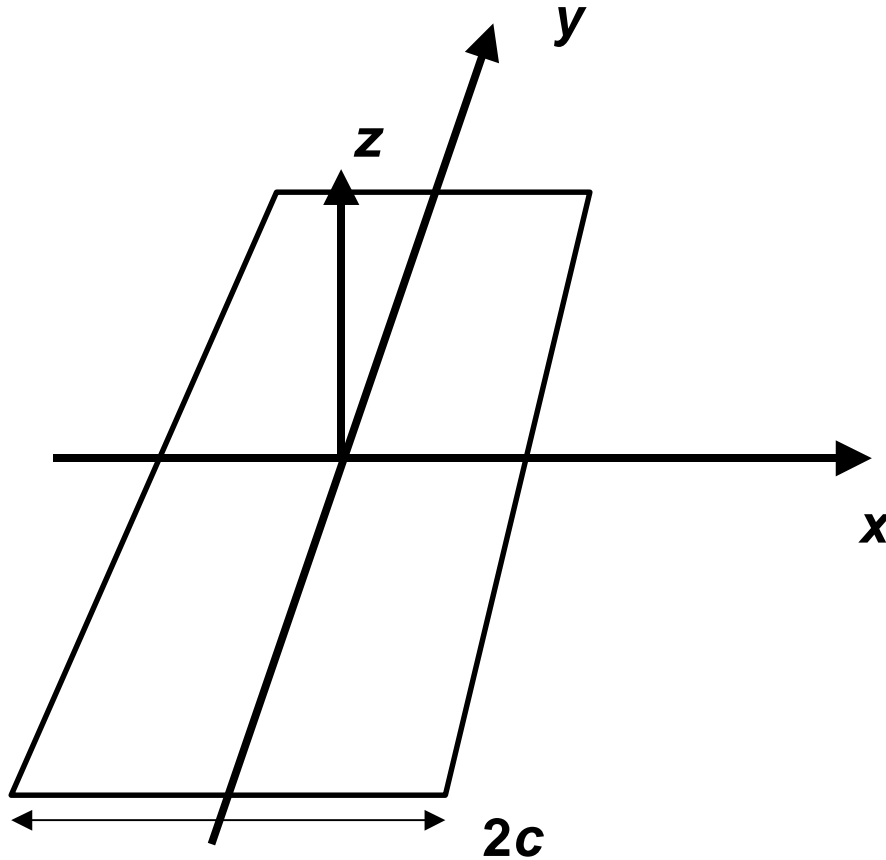

For such a shape, the aperture (normal displacement or closure) can be determined analytically as (at the mid-section)

$$\delta = 4(1-\nu^2)/E p \sqrt{(c^2-x^2)} \quad [6]$$

where  $E$  and  $\nu$  represent respectively Young's modulus and Poisson's ratio, and  $p$  represents the homogeneous pre-mining stress state. The stress ahead of the crack tip can also be determined analytically as

$$\sigma = px / \sqrt{(x^2-c^2)} \quad [7]$$

The work done in deforming the crack surfaces is equivalent to the total energy released and can be determined as follows (the integral is taken from  $-c$  to  $+c$ )

$$\begin{aligned} W &= \frac{1}{2} \int p \delta dx \\ &= 2\pi (1-\nu^2) p^2/E \int \sqrt{(c^2-x^2)} dx \quad [8] \end{aligned}$$

$$= \pi (1-\nu^2) p^2 c^2 / E$$

As the length of the crack increases, the energy release per unit length of crack extension can be determined by differentiation as

$$dW/dc = 2\pi (1-\nu^2) p^2 c / E \quad [9]$$

For extension of one end of the crack only, we obtain the energy release rate as half this value

$$ERR = \pi (1-\nu^2) p^2 c / E \quad [10]$$

### Comparison with Planar Crack Solution

If we now compare the planar crack geometry with the crack-tip formulation, it can be observed that for planar crack (comparing equations [1] and [2] with [6] and [7])

$$p_\delta = 4(1-\nu^2)/E p \sqrt{2c} \quad [11]$$

$$p_\sigma = p \sqrt{c/2} \quad [12]$$

Observation of these equations reveals that these two parameters can be related in the case of a planar crack geometry by

$$p_\delta = 8(1-\nu^2)/E p_\sigma \quad [13]$$

Substituting these into equation [5] for *ERR* provides

$$ERR = \pi (1-\nu^2) p^2 c / E \quad [14]$$

the same result as determined for the planar crack (equation [10]).

Various substitutions for  $p_\delta$  and  $p_\sigma$  can be made to determine

$$ERR = 2\pi (1-\nu^2) \pi p_\sigma^2 / E \quad [15]$$

and

$$ERR = 1/32 \pi p_\delta^2 E / (1-\nu^2) \quad [16]$$

This later equation is the same expression derived by Ryder and Jager (their equation [11], p. 236, Rock Mechanics for Tabular Hard Rock Mines, 2002). They state that this equation is used to calculate *ERR* in MINSIM. Some form of  $\alpha$ -edge correction (Ryder and Napier, Numerical Methods in Geomechanics, Nagoya, 1985) is also apparently implemented but the details on exactly how this done are unclear.

### *ERR* Calculation in Map3D

Both of  $p_\delta$  and  $p_\sigma$  can be determined from numerical modelling.

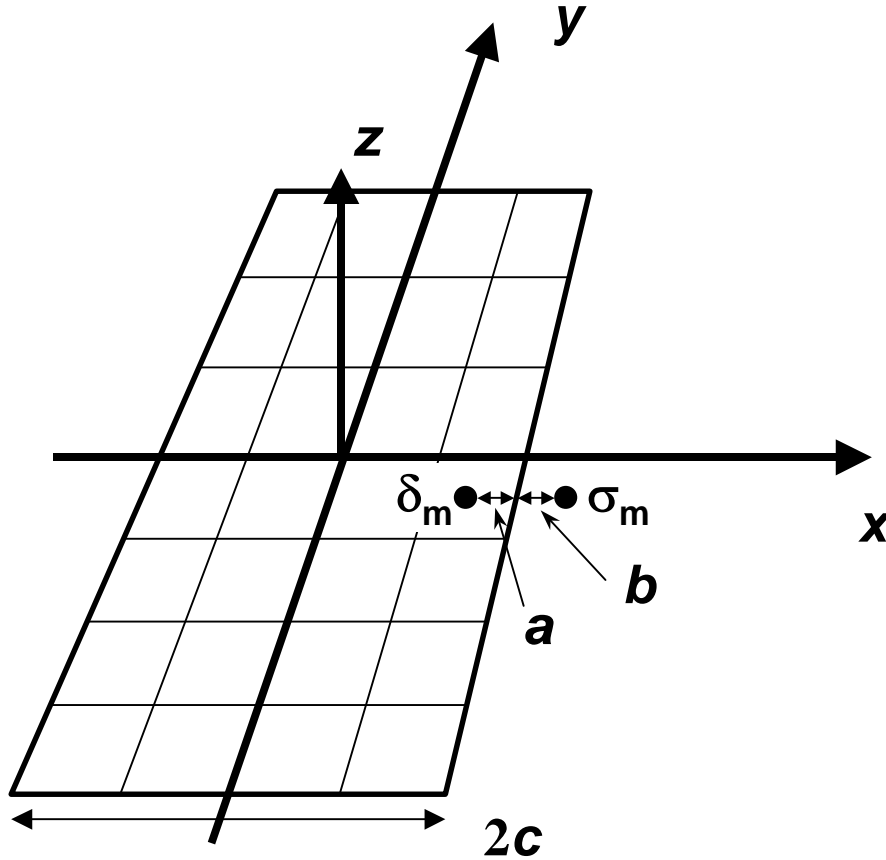

For example, given the normal displacement (closure)  $\delta_m$  determined at distance  $a$  behind the advancing face,  $p_\delta$  can be determined using equation [1] as

$$p_\delta = \delta_m / \sqrt{a} \quad [17]$$

Similarly, given the stress  $\sigma_m$  at distance  $b$  ahead of the advancing face,  $p_\sigma$  can be determined using equation [2] as

$$p_\sigma = \sigma_m \sqrt{b} \quad [18]$$

Note that there is no reason for  $a$  to be equal to  $b$  and hence there is no requirement for uniform boundary element sizes.

Once either or both of  $p_\delta$  and  $p_\sigma$  are determined,  $ERR$  is readily calculated from equation [5], [15] or [16].

Detailed studies of stress and displacement distributions near the crack tip reveal that for constant DD elements, both the aperture and stress are consistently over-estimated. Fortunately, the degree of over-estimation is closely related to the element size and it can be found that if  $a$  is multiplied by  $3/2$  and  $b$  is multiplied by  $2/3$ , much more accurate results can be obtained. With these substitutions, and using equation [17] and [18],  $ERR$  can be determined from

$$ERR = 1/6 \pi \delta_m \sigma_m \sqrt{(2/3 b)} / \sqrt{(3/2 a)}$$

$$= 1/6 \pi \delta_m \sigma_m \sqrt{(b/a)} \quad [19]$$

This equation is used to calculate *ERR* in Map3D.

### An Example

With *E* of 60000 MPa, *v* of 0.25, *p* of 100 MPa and *c* of 100 m we calculate theoretical values for *p<sub>o</sub>* of 707.11, *p<sub>o</sub>* of 0.088388 and 49.1 MN/m for *ERR*

This can be modelled using Map3D using uniform elements of width *w*, to provide the following results:

<i>w</i> (m)	<i>b = a</i> (m)	$\sigma_m$ (MPa)	$\delta_m$ (m)	<i>ERR</i> (MN/m)	error
50	25	197.567	0.5209	53.9	+9.8%
25	12.5	262.669	0.3754	51.6	+5.2%
12.5	6.25	358.943	0.2679	50.3	+2.5%
10	5	398.56	0.2402	50.1	+2.1%
6.25	3.125	498.323	0.1903	49.6	+1.0%
5	2.5	554.58	0.1705	49.5	+0.9%
3.125	1.5625	697.764	0.1349	49.3	+0.4%

Note that the stress  $\sigma_m$  and normal displacement (closure)  $\delta_m$  are determined at the element centres. Since uniform element widths were used, *a* equals *b* equals  $\frac{1}{2}w$

#### 4.3.7.12 SF-D Strength/Stress

Contours the strength/stress ratio on DD elements.

In elastic analysis the maximum in-plane shear stress is normally used with the in-plane normal stress and the Mohr-Coulomb strength criterion to estimate the amount of slip due to over-stressing, on a fault, joint set or bedding plane.

By contrast, in non-linear analysis the maximum in-plane shear stress can never exceed the strength unless some creep is used. In this latter case, viscous creep can allow stress states above the failure criterion, thus indicating a lack of static equilibrium. Hence for non-linear analysis one normally directly considers the amount of slip predicted by the model

[Mohr-Coulomb in DD planes](#)

[Fault-Gouge in DD planes](#)

[Backfill-Hyperbolic in DD planes](#)

### Mohr-Coulomb

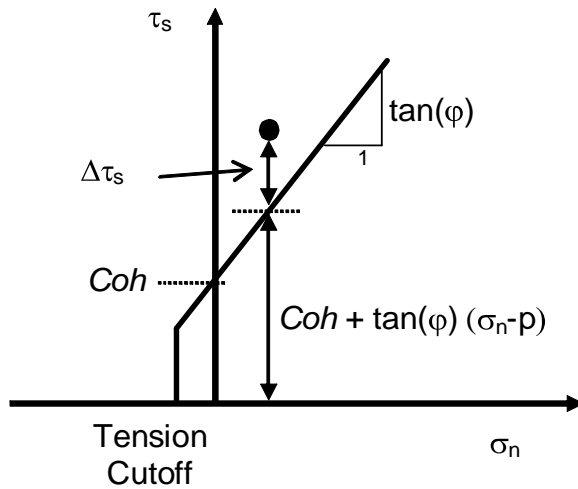

**Strength/Stress** can be determined as  $[ \text{Cohesion} + (\sigma_n - p) \tan(\phi) ] / \tau_s$

**dTs Excess Shear Stress** can be determined as  $\Delta\tau_s = \tau_s - [ \text{Cohesion} + (\sigma_n - p) \tan(\phi) ]$

If fluid pressure is specified as part of the [Stress State](#), the effective normal stress ( $\sigma_n - p$ ) is used (here  $p$  is the fluid pressure).

The contour range is set using

**Range** [Plot > Range](#)

This component can be added to the contour toolbar if desired

**Conf** [Tools > Configure Contouring Toolbar](#)

#### Related Topics:

**dTs** [Plot > Surface Components > dTs - Excess Shear Stress](#)

#### 4.3.7.13 Excess Shear Stress

Contours the excess stress  $\Delta\tau_s$  on DD elements.

This feature is used only in non-linear analyses (3D FF blocks in Map3D Non-Linear and DD planes in Map3D Fault-Slip). For details refer to

[CAD > Properties > Material Properties](#)

At each creep step the stress state on all yielding elements (elements where the stress exceeds the strength) is calculated as the strength plus the creep resistance. This limits the size of plastic creep increment  $\Delta\epsilon_{\text{plastic}}$  on each yielding element

$$\tau_s = \text{Strength} + C \Delta\epsilon_{\text{plastic}} / \Delta t$$

$$C = G \Delta t$$

where the creep resistance is determined as the creep coefficient  $C$ , times the plastic strain rate. Note that the user must select both the creep coefficient  $C$ , and the time step size  $\Delta t$ , then specify

the quotient of these as the viscous modulus  $G$ . The contribution to the stress  $\tau_s$ , made by the creep increment is the excess stress given by

$$\Delta\tau_s = C \Delta\varepsilon_{\text{plastic}} / \Delta t$$

The accumulated plastic strain  $\varepsilon_{\text{plastic}}$ , is determined as the sum of the plastic creep increments  $\Delta\varepsilon_{\text{plastic}}$ , for all creep steps.

#### Related Topics:

 [Plot > Surface Components > dEs - Incremental Shear Strain](#)

 [Plot > Surface Components > Ts - Shear Stress](#)

 [Plot > Surface Components > Es - Shear Strain](#)

[Analysis > Options > Creep](#)

#### 4.3.7.14 Incremental Shear Strain

Contours the plastic creep increment  $\Delta\varepsilon_{\text{plastic}}$  on DD elements.

This feature is used only in non-linear analyses (3D FF blocks in Map3D Non-Linear and DD planes in Map3D Fault-Slip). For details refer to

[CAD > Properties > Material Properties](#)

At each creep step the stress state on all yielding elements (elements where the stress exceeds the strength) is calculated as the strength plus the creep resistance. This limits the size of plastic creep increment  $\Delta\varepsilon_{\text{plastic}}$  on each yielding element

$$\tau_s = \text{Strength} + C \Delta\varepsilon_{\text{plastic}} / \Delta t$$

$$C = G \Delta t$$

where the creep resistance is determined as the creep coefficient  $C$ , times the plastic strain rate. Note that the user must select both the creep coefficient  $C$ , and the time step size  $\Delta t$ , then specify the quotient of these as the viscous modulus  $G$ . The contribution to the stress  $\tau_s$ , made by the creep increment is the excess stress given by

$$\Delta\tau_s = C \Delta\varepsilon_{\text{plastic}} / \Delta t$$

The accumulated plastic strain  $\varepsilon_{\text{plastic}}$ , is determined as the sum of the plastic creep increments  $\Delta\varepsilon_{\text{plastic}}$ , for all creep steps.

Note that since the user must select the time step size  $\Delta t$ , in order to define the viscous modulus  $G$ , the shear strain rate is easily determined from the incremental shear strain  $\Delta\varepsilon_{\text{plastic}}$ , simply by dividing by the time step size.

#### Related Topics:

 [Plot > Surface Components > dTs - Excess Shear Stress](#)

 [Plot > Surface Components > Ts - Shear Stress](#)

 [Plot > Surface Components > Es - Shear Strain](#)

[Analysis > Options > Creep](#)

#### 4.3.7.15 Stress/Strain rate

Contours the excess stress divided by the plastic creep increment  $\Delta\tau_s / \Delta\epsilon_{\text{plastic}}$  on DD elements.

This feature is used only in non-linear analyses (3D FF blocks in Map3D Non-Linear and DD planes in Map3D Fault-Slip). For details refer to

[CAD > Properties > Material Properties](#)

At each creep step the stress state on all yielding elements (elements where the stress exceeds the strength) is calculated as the strength plus the creep resistance. This limits the size of plastic creep increment  $\Delta\epsilon_{\text{plastic}}$  on each yielding element

$$\tau_s = \text{Strength} + C \Delta\epsilon_{\text{plastic}} / \Delta t$$





$$C = G \Delta t$$

where the creep resistance is determined as the creep coefficient  $C$ , times the plastic strain rate. Note that the user must select both the creep coefficient  $C$ , and the time step size  $\Delta t$ , then specify the quotient of these as the viscous modulus  $G$ . The contribution to the stress  $\tau_s$ , made by the creep increment is the excess stress given by

$$\Delta\tau_s = C \Delta\epsilon_{\text{plastic}} / \Delta t$$

The accumulated plastic strain  $\epsilon_{\text{plastic}}$ , is determined as the sum of the plastic creep increments  $\Delta\epsilon_{\text{plastic}}$ , for all creep steps.

#### Related Topics:

-  [Plot > Surface Components > dTs - Excess Shear Stress](#)
-  [Plot > Surface Components > dEs - Incremental Shear Strain](#)
-  [Plot > Surface Components > Ts - Shear Stress](#)
-  [Plot > Surface Components > Es - Shear Strain](#)

[Analysis > Options > Creep](#)

#### 4.3.7.16 Cohesion

Contours the Cohesion and Friction angle of the gouge material.

This is of particular interest when you use the [Equilibrated-Gouge](#) material type since the cohesion and friction angle can vary from place to place..

#### 4.3.7.18 Temperature/Head

Contours the temperature or head.

[Map3D Thermal-Fluid Flow](#) can be used to simultaneously solve steady state heat/fluid flow coupled to the stress analysis. The program is set up so that the user need only specify the temperature/head boundary conditions, then the coupled thermal/fluid flow stress problem is solved simultaneously. This feature is useful for the simulation of heating or cooling effects and drained or undrained response of soils.

For more details refer to

[Expansion Coefficient and Conductivity](#)



The contour range is set using

 [Plot > Range](#)

This component can be added to the contour toolbar if desired

 [Tools > Configure Contouring Toolbar](#)

#### 4.3.7.19 Normal Flux

Contours the flow rate normal to the surface.

[Map3D Thermal-Fluid Flow](#) can be used to simultaneously solve steady state heat/fluid flow coupled to the stress analysis. The program is set up so that the user need only specify the temperature/head boundary conditions, then the coupled thermal/fluid flow stress problem is solved simultaneously. This feature is useful for the simulation of heating or cooling effects and drained or undrained response of soils.

For more details refer to

[Expansion Coefficient and Conductivity](#)

The contour range is set using

 [Plot > Range](#)

This component can be added to the contour toolbar if desired

 [Tools > Configure Contouring Toolbar](#)

#### 4.3.7.20 Value

##### 4.3.7.20.1 Elastic strain

Selects the elastic, plastic or total strain component.

For details, refer to

[Mohr-Coulomb in 3D FF blocks.](#)

##### 4.3.7.20.4 Absolute Strain

Plot the induced or absolute strain component.

Induced strain is the strain without the pre-mining strain contribution. This represents the strain change since the pre-mining condition.

Absolute strain is the strain including the pre-mining strain contribution.

Also see:

 [Plot > Stress > Value > Induced Strain](#)

 [Plot > Stress > Value > Absolute Strain](#)

## 4.3.7.20.6 Induced Stress

Plot the induced or absolute stress component.

Induced stress is the stress without the pre-mining stress contribution. This represents the stress change since the pre-mining condition.

Absolute stress is the stress including the pre-mining stress contribution.

Also see:

 [Plot > Strain > Value > Induced Strain](#)

 [Plot > Strain > Value > Absolute Strain](#)

## 4.3.8 Miscellaneous

### 4.3.8.1 Delem Distance to nearest element on surfaces

Contours the distance to the nearest element from each surface.

*Delem* is determined by Map3D as the smallest distance between adjacent model surfaces.

During the discretization process all model surfaces (surfaces of FF blocks and DD planes) are subdivided into boundary elements with side length

*Delem /DON*

During matrix assembly, all elements that fit within the dimension

*Delem/DOC*

will be lumped together.

For more details refer to

[CAD > Properties > Control Parameters.](#)

#### Related topics:

 [Plot > Miscellaneous > Delem/Lelem - DON ratio on surfaces](#)

### 4.3.8.2 Dgrid Distance to nearest grid on surfaces

Contours the distance to the nearest grid from each surface.

*Dgrid* is determined by Map3D as the smallest distance between model surfaces and grid planes.

During the discretization process all model surfaces (surfaces of FF blocks and DD planes) are subdivided into boundary elements with side length

*Dgrid/DOL*

During grid assembly, all elements that fit within the dimension

*Dgrid/DOE*

will be lumped together.

During grid assembly, all grid points that fit within the dimension

*Dgrid/DOG*

will be lumped together.

For more details refer to

[CAD > Properties > Control Parameters](#)

**Related topics:**

 [Plot > Miscellaneous > Delem/Lelem - DON ratio on surfaces](#)

**4.3.8.3 Delem/Lelem DON ratio on surfaces**

Contours the distance to the nearest element *Delem* divided by the element width *Lelem*.

*Delem* is determined by Map3D as the smallest distance between adjacent model surfaces.

Small values of *DON* can be related to convergence problems.

For more details refer to

[CAD > Properties > Control Parameters.](#)

**4.3.8.4 Dgrid/Lelem DOL ratio on surfaces**

Contours the distance to the nearest grid *Dgrid* divided by the element width *Lelem*.

*Dgrid* is determined by Map3D as the smallest distance between model surfaces and grid planes.

Small values of *DOL* can be related to low accuracy predictions (*DOL*=1 for 10-20% error, *DOL*=2 for 5-10% error, *DOL*=4 for < 5% error).

For more details refer to

[CAD > Properties > Control Parameters.](#)

**4.3.8.5 Dratio on surfaces**

Contours the coefficient ratio on surfaces.

This ratio identifies locations where surfaces are very close to one-another, indicating possible construction errors.

**4.3.8.6 Dgrid Distance to nearest element on grids**

Contours the distance to the nearest surface from each grid point.

*Dgrid* is determined by Map3D as the smallest distance between grid planes and model surfaces.

During the discretization process all grid planes are subdivided into elements with side length

*Dgrid/DOL*

During grid assembly, all elements that fit within the dimension

*Dgrid/DOE*

will be lumped together.

During grid assembly, all grid points that fit within the dimension

*Dgrid/DOG*

will be lumped together.

For more details refer to

[CAD > Properties > Control Parameters](#)

**Related topics:**

 [Plot > Miscellaneous > Dgrid/Lgrid DOL ratio on grids](#)

**4.3.8.7 Dgrid/Lgrid DOL ratio on grids**

Contours the distance to the nearest grid *Dgrid* divided by the grid spacing *Lgrid*.

*Dgrid* is determined by Map3D as the smallest distance between model surfaces and grid planes.

Small values of *DOL* can be related to low accuracy predictions (*DOL*=1 for 10-20% error, *DOL*=2 for 5-10% error, *DOL*=4 for < 5% error).

For more details refer to

[CAD > Properties > Control Parameters](#)

**4.3.8.8 Matl# - Material Number on Grids**

Plots material number as coloured contour.

**4.3.9 Contour Range**

Specifies the contour range (minimum, maximum, interval ...) of the currently plotted contour.

This routine can be initiated either by picking the  button or simple right clicking on any contour.

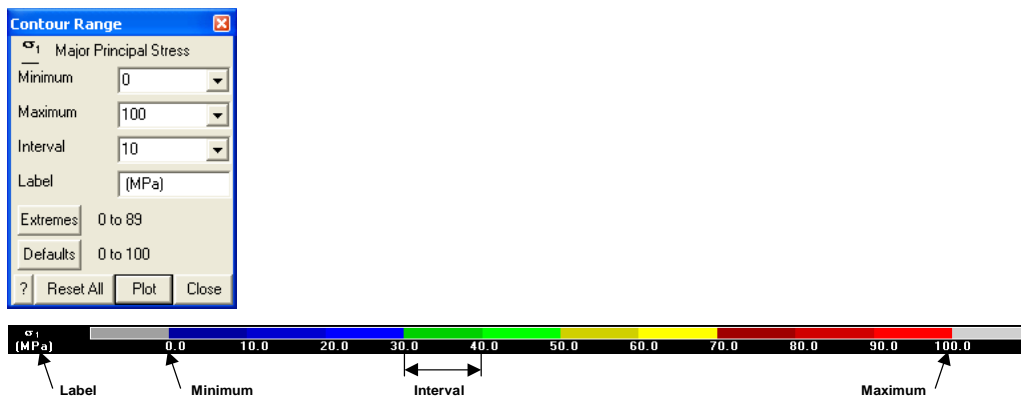

**Minimum** - specifies the lower value of the contour range.

**Maximum** - specifies the upper value of the contour range.

**Interval** - specifies the contour interval. The interval can be set larger than 1/10th of the maximum minus the minimum, but not smaller.

**Label** - specifies the contour label.

**Extremes** – Indicates the lower and upper extremes detected for this parameter. Selecting this button set the contour range to these values.

**Defaults** - Indicates the default lower and upper contour range for this parameter. Selecting this button set the contour range to these values.

**Reset All** - Sets the ranges of all plot parameters to the default values.

**Plot** – regenerates the contour plot.

The minimum contour range does not necessarily have to be set less than the maximum. For example when contouring strength factors it may be desirable to set the minimum to 2 and the maximum to 1 so that strength factors near one are contoured in the colour red.

#### 4.3.10 Grid Selection

Selects a field point grid for viewing.



Analysis results (stresses, strains and displacements) can be contoured on element surfaces and on field point grids.

With OpenGL enabled ([Tools > OpenGL](#)), all grids can be displayed simultaneously. Without OpenGL enabled, only two grids can be displayed simultaneously.

 **Hull** Hide All - Hides all grids.

 **UHull** Unhide All - Unhide all grids.

The user can construct multiple field point grid planes using

 [CAD > Build > Grid Plane](#)

 [CAD > Build > Grid Line](#)

Individual grid selection buttons can be placed on the view toolbar if desired using

[Tools > View Toolbar Configure](#)

#### 4.3.11 Plot Options

Sets up contour plot options.

This routine can be initiated either by picking the  button or simple right clicking on any contour.

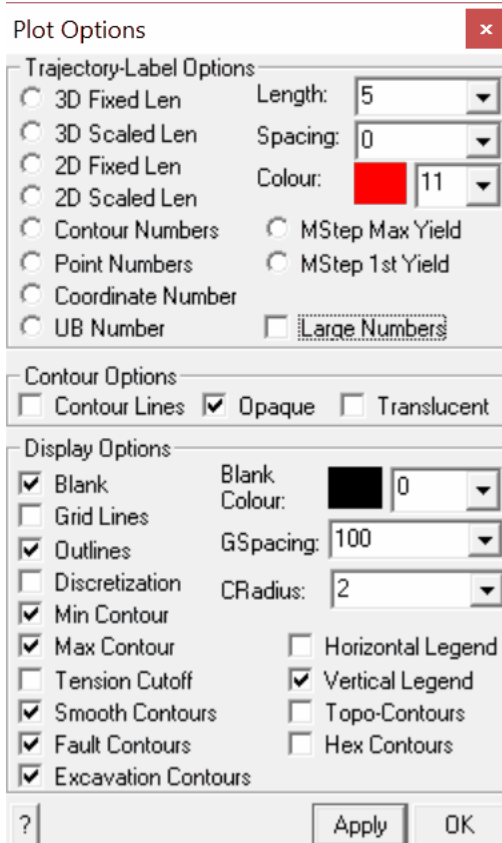

### Trajectory-Label Options:

**3D Fixed Length** – display fixed length 3D orientation indicators.

The indicator is constructed as a 3D vector with an arrow head placed on the end that points away from you (i.e. into the display). This permits you to determine whether the vector is dipping away from you or towards you. Vectors that appear as dots point directly into or away from the display.

If you orient the view such that you are looking along the edge of a grid, you will see the vectors protruding in and out of the contour plane.

The length of the vectors is set with the **TLength:** parameter.

The density of the vectors is set with the **TSpacing:** parameter.

**3D Scaled Length** – display scaled length 3D orientation indicators.

The indicator is constructed as described above.

The length of the vectors are scaled to the stress magnitude such that if the magnitude equals the minimum of the contour range, the vector is drawn with zero length. If the magnitude equals the maximum of the contour range, the vector is drawn with the length specified by the **TLength:** parameter.

**2D Fixed Length** – display fixed length 2D orientation indicators.

The indicator is constructed as a 2D projection of the true 3D vector, in the plane of the grid.

The length of the vectors is set with the [TLength](#): parameter.

The density of the vectors is set with the [TSpacing](#): parameter.

[2D Scaled Length](#) – display scaled length 2D orientation indicators.

The indicator is constructed as described above.

The indicator is constructed as a 2D projection of the true 3D vector, in the plane of the grid.

The length of the vectors are scaled to the stress magnitude such that if the magnitude equals the minimum of the contour range, the vector is drawn with zero length. If the magnitude equals the maximum of the contour range, the vector is drawn with the length specified by the [TLength](#): parameter.

[Contour Numbers](#) – display contour numbers on the contours. The number corresponds to the magnitude of the contour at each point.

[Point Numbers](#) – display point numbers on the contours. The number corresponds to the record number of each point.

[Coordinate Numbers](#) – display coordinate numbers on the contours. The number corresponds to the x,y,z coordinates of each point.

[UB Number](#) – display the number of the ubiquitous joint set (1, 2 or 3) with the maximum excess shear stress on the contours. Refer to [Ubiquitous Parameters](#)

[MStep Max Yield](#) – display the step at which the maximum excess stress occurs. Refer to [Accumulated Damage](#)

[MStep 1st Yield](#) – display the step at which the first yield occurs. Refer to [Accumulated Damage](#)

[Large Numbers](#) – display numbers with large size or small size.

[Length](#) – set the length that the orientation indicators will be drawn. If you set this parameter too small, the trajectory vectors will be too small to see. If you set this parameter too large, the trajectory vectors will overlap and create a confusing display.

[Spacing](#) – set the spacing between adjacent orientation indicators or numbers. If set this parameter to zero, trajectories will be drawn at all grid points. For finely discretized grids, the trajectory vectors may be too concentrated and difficult to distinguish. Larger values for this parameter will result in fewer trajectory symbols being drawn.

[Colour](#) – set the colour with which the trajectories are drawn.

#### **Contour Options:**

[Contour Lines](#) – draws lines between the contour colours. These lines help highlight the boundary between different contour intervals and are particularly useful for black and white presentation.

[Opaque](#) – draws the contours as opaque colours. If both this option and the translucent option are unchecked, only contour lines (i.e. no coloured contour) will be drawn.

[Translucent](#) - draws the contours as translucent colours. If both this option and the opaque option are unchecked, only contour lines (i.e. no coloured contour) will be drawn.

#### **Display Options:**

[Blank](#) – when checked, contours are blanked out where the grid plane passes through excavation blocks. This is useful to identify the extent of excavations when portions of the model have been hidden. It is also useful for generation of 2D sections since the location of the excavations are

clearly visible.

**Blank Colour:** - sets colour used for Blanking.

**Grid Lines** – contours are drawn with lines at regular grid intervals. The desired interval is set using the Spacing: parameter.

**Outlines** – outlines are drawn around the grid edges. When using multiple grids you may not want to see these outlines.

**Discretization** – the grid discretization is superimposed on the contours.

**Min Contour** – when unchecked, contours below the minimum contour range are not drawn. This is useful for displaying contours where only the upper part of the contour range is important.

For example when displaying non-linear strain components or excess stresses, it is often useful to only have non-zero portions of the contours visible.

If the desired parameter has a negative value simply swap the maximum and minimum contour range or plot the absolute value of the parameter.

**Max Contour** – when unchecked, contours above the maximum contour range are not drawn.

**Tension Cutoff Symbol** – when checked a special tension symbol will be plotted anywhere the stress state is below the specified tension cutoff. This option is only used for strength factor plots.

**Smooth Contours** – if you have not checked the linear analysis option, results are only calculated at the centre of each boundary element and contour plots of surface values will appear very checkered. This option smoothes these contours to assist in interpretation.

If you have checked the linear analysis option results are calculated at element corners. Since no smoothing is required this option is ignored.

This option has no effect on grid plots.

**Fault contours** – Contours are drawn on fault surfaces. These are DD surfaces with fault-gouge material type.

**Excavation contours** – Contours are drawn on excavation surfaces. These are FF or DD surfaces with 0 material type.

**Horizontal Banner** - orients the contour interval banner horizontally.

**Vertical Banner** - orients the contour interval banner vertically.

**Topo-Contours** – display contours as a topographical surface.

The height normal to the plane is scaled to the stress magnitude such that if the magnitude equals the minimum of the contour range, the height is drawn with zero length. If the magnitude equals the maximum of the contour range, the vector is drawn with the length specified by the **CRadius:** parameter.

For line grids, the radius of the tube is scaled.

**Hex contours** – in the Visco-Plastic version of Map3D this will enable display of values calculated at internal node points.

**GSpacing:** - sets the grid interval.

**CRadius** - sets the radius for contouring of line grids.

**Miscellaneous:**



[Apply](#) – regenerates the contour plot.

## 4.3.12 Properties

### 4.3.12.1 Control Parameters

Specification of analysis control parameters.

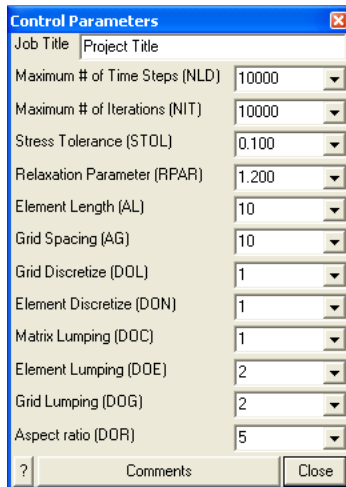

**Job Title** - specifies a descriptive project title.

**Maximum # of Time Steps (NLD)** - specifies the maximum number of steps that will be used during analysis. This parameter is only relevant if you are conducting a non-linear creep analysis

[Analysis > Options > Creep](#)

where this limits the actual number of time steps.

If this parameter is exceeded, the program stops and the user is prompted for instructions on how to proceed. This parameter can be modified during solution.

Unless the user has some special reason for limiting the number of time steps this parameter should be set to an arbitrarily large number.

**Maximum # of Iterations (NIT)** - specifies the maximum number of iterations that will be used during matrix solution.

If this parameter is exceeded, the program stops and the user is prompted for instructions on how to proceed. This parameter can be modified during solution.

Unless the user has some special reason for limiting the number of time steps this parameter should be set to an arbitrarily large number.

**Stress Tolerance (STOL)** - specifies the required accuracy of the matrix solution.

During matrix solution the accuracy is successively improved with each iteration. When the maximum stress error falls below this value the matrix can be considered to be solved.

The suggested value for the parameter is 0.1% of the far field stress state at the depth of interest.

*STOL* should be specified in the same units as the far field stress state (e.g. MPa or psi).

**Relaxation Parameter (RPAR)** - specifies the maximum relaxation value that will be used during matrix solution.

During matrix solution the program continuously modifies the relaxation parameter in an attempt to obtain convergence with as few as possible iterations. This parameter limits the maximum value that will be used.

The value of 1.2 is recommended for well-conditioned problems. For poorly conditioned problems a value of 0.8 should be used.

**Element Length (AL)** - specifies the minimum element length.

During the discretization process all model surfaces (surfaces of FF blocks and DD planes) are subdivided into boundary elements with side length

$$Lelem = Delem/DON$$

where *Delem* is determined by Map3D as the smallest distance between adjacent model surfaces. Since at some locations the distance *Delem* may be zero, the minimum element side length *AL* must be specified.

*AL* should be set equal to twice the smallest pillar or stope width. The same units used to specify the coordinates should be used (e.g. metres or feet).

Once discretization is complete, the distance *Delem* can be plotted using

 [Plot > Miscellaneous > Delem](#) distance to nearest element on surfaces.

Note that if desired, this behaviour can be overridden on an element by element basis by specifying the maximum width for each element

 [CAD > Edit > Entity Properties > Maximum Width](#)

This allows users to force fine uniform discretization on surfaces in areas where there are no grid planes.

**Grid Spacing (AG)** - specifies the minimum grid spacing.

During the discretization process all field point grids and model surfaces are subdivided into elements with side length

$$Lgrid = Dgrid/DOL$$

where *Dgrid* is determined by Map3D as the smallest distance between model surfaces and grid planes. Since at some locations the distance *Dgrid* may be zero, the minimum grid spacing *AG* must be specified. This same process is used to discretize model surfaces (surfaces of FF blocks and DD planes) that are near field point grids.

*AG* should be set equal to the smallest dimension of interest. For example if the user needs to see the stress distribution across a 2m wide pillar, a value for *AG* of 0.5 would give sufficient number of field points for accurate contouring. The same units used to specify the coordinates should be used (e.g. metres or feet).

Once discretization is complete, the distance *Dgrid* can be plotted on model surfaces using

 [Plot > Surface Components > Dgrid](#) distance to nearest grid

or on grids using

 [Plot > Miscellaneous > Delem](#) distance to nearest element on grids.

Note that if desired, this behaviour can be overridden on a grid by grid basis by specifying the maximum spacing for each grid

 [CAD > Edit > Entity Properties > Maximum Width](#)

This allows users to force fine uniform discretization on grids.

**Grid Discretize (*DOL*)** - specifies the desired distance to element length ratio used to determine the grid spacing from

$$L_{grid} = D_{grid}/DOL$$

where *Dgrid* is determined by Map3D as the smallest distance between model surfaces and grid planes.

A value for *DOL* of 1.0 is generally adequate and can be expected to provide solutions with 10-20% error. If higher accuracy is required a value for *DOL* of 2.0 should give 5-10% error. Use a value of 4.0 for less than 5% error. Although higher values of *DOL* results in generation of more boundary elements and hence longer run times, this is necessary to obtain increased accuracy.

Once discretization is complete, the ratio of *Dgrid/Lelem* can be plotted on model surfaces using

 [Plot > Miscellaneous > Dgrid/Lelem](#) *DOL* ratio on surfaces

or the ratio of *Dgrid/Lgrid* on grids using

 [Plot > Miscellaneous > Dgrid/Lgrid](#) *DOL* ratio on grids.

**Element Discretize (*DOM*)** - specifies the desired distance to element length ratio used to determine the element side length

$$Lelem = Delem/DON$$

where *Delem* represents the distance to the nearest model surface.

A value for *DON* of 0.5 is generally adequate for all problems except those with very narrow excavations or pillars. In this latter case a value for *DON* of 1.0 is recommended. Although higher values of *DON* results in generation of more boundary elements and hence longer run times, this is necessary to obtain a well conditioned solvable problem for very narrow excavations or pillars.

Once discretization is complete, the ratio of *Delem/Lelem* can be plotted using

 [Plot > Miscellaneous > Delem/Lelem](#) *DON* ratio on surfaces.

**Matrix Lumping (*DOC*)** - specifies the desired distance to element length ratio. During matrix assembly, all elements that fit within the dimension

$$Delem/DOC$$

will be lumped together. *Delem* represents the distance to the nearest model surface.

Just as for *DOL*, a value for *DOC* of 1.0 is generally adequate and can be expected to provide solutions with 10-20% error. If higher accuracy is required a value for *DOC* of 2.0 should give 5-10% error. Use a value of 4.0 for less than 5% error. Although higher values of *DOC* result in larger coefficient matrices and hence longer run times, this is necessary to obtain increased accuracy.

Once discretization is complete, the distance *Delem* can be plotted using

 [Plot > Miscellaneous > Delem](#) distance to nearest element on surfaces.

**Element Lumping (DOE)** - specifies the desired distance to element length ratio. During grid assembly, all elements that fit within the dimension

*Dgrid/DOE*

will be lumped together. *Dgrid* represents the distance to the nearest field point grid surface.

A value for *DOE* of 2.0 is generally adequate and can be expected to provide solutions with 10-20% error. If higher accuracy is required a value for *DOE* of 4.0 should give 5-10% error. Use a value of 8.0 for less than 5% error. Although higher values of *DOE* result in longer run times, this is necessary to obtain increased accuracy.

Once discretization is complete, the distance *Dgrid* can be plotted on grids using

 [Plot > Miscellaneous > Delem](#) distance to nearest element on grids.

**Grid Lumping (DOG)** - specifies the desired distance to element length ratio. During grid assembly, all grid points that fit within the dimension

*Dgrid/DOG*

will be lumped together. *Dgrid* represents the distance to the nearest field point grid surface.

A value for *DOG* of 2.0 is generally adequate and can be expected to provide solutions with 10-20% error. If higher accuracy is required a value for *DOG* of 4.0 should give 5-10% error. Use a value of 8.0 for less than 5% error. Although higher values of *DOG* result in longer run times, this is necessary to obtain increased accuracy.

Once discretization is complete, the distance *Dgrid* can be plotted on grids using

 [Plot > Miscellaneous > Delem](#) distance to nearest element on grids.

**Aspect Ratio (DOR)** - specifies the desired element aspect ratio. A value for *DOR* of 5.0 is recommended for all problems except where the user wants narrow elements subdivided into more uniform shapes.

**Comments** - allows you to specify comments to be saved with the run.

#### Summary:

*STOL* should be set equal to 0.1% of the far field stress state at the depth of interest. Use the same units as the far field stress state (e.g. MPa or psi).

*AL* should be set equal to twice the smallest pillar or stope width. Use the same units used to specify the coordinates (e.g. metres or feet).

*AG* should be set equal to the smallest dimension of interest. Use the same units used to specify the coordinates (e.g. metres or feet).

*DON*=0.5, *DOL*=*DOC*=1, *DOE*=*DOG*=2 for 10-20% error.

*DON*=0.5, *DOL*=*DOC*=2, *DOE*=*DOG*=4 for 5-10% error.

*DON*=1, *DOL*=*DOC*=4, *DOE*=*DOG*=8 for < 5% error.

Elements are discretized to a side length that is the smaller of *Delem/DON* and *Dgrid/DOL*, such that it cannot be less than *AL* and cannot be larger than the maximum width.

Grid are discretized to a spacing is determined from *Dgrid/DOL* such that is cannot be less than *AG*

and cannot be larger than the maximum spacing.

During matrix assembly, all elements that fit within the dimension *Delem/DOC* will be lumped together.

During grid assembly, all elements that fit within the dimension *Dgrid/DOE* will be lumped together.

During grid assembly, all grid points that fit within the dimension *Dgrid/DOG* will be lumped together.

**Notes:**

For a more detailed discussion on discretization and lumping refer to

[Discretization and Lumping](#).

#### 4.3.12.2 Mining Step Titles

Specification of a specifies a descriptive title for each mining step.

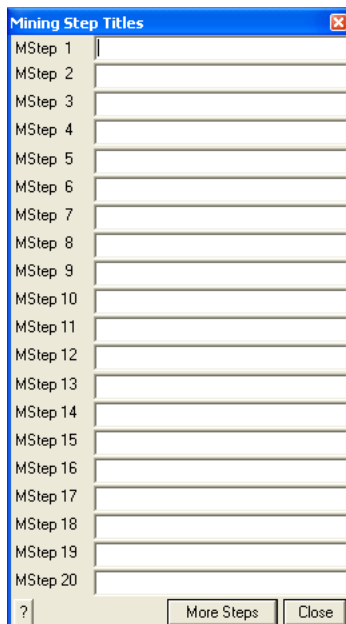

#### 4.3.12.3 Material Properties

Specification of material properties.

Several different dialogue boxes will appear depending on the material type selected: Mohr-Coulomb, Hoek-Brown, Drucker-Prager, Backfill Hyperbolic and None.

[Mohr-Coulomb in 3D FF blocks](#) can be used as a flow rule for non-linear material behaviour in Map3D Non-Linear and Map3D Visco-Plastic. Can also be used as failure criterion in 3D FF blocks or in the host material in Map3D Fault-Slip.

[Hoek-Brown in 3D FF blocks](#) can be used as failure criterion in 3D FF blocks or in the host material in Map3D Fault-Slip.

[Drucker-Prager in 3D FF blocks](#) can be used as failure criterion in 3D FF blocks or in the host

material in Map3D Fault-Slip.

[Fault-Gouge in DD planes](#) can be used as a flow rule in DD planes in Map3D Fault-Slip, Map3D Non-Linear or Map3D Visco-Plastic.

[Hyperbolic-Backfill in DD planes](#) can be used as a flow rule in DD planes in Map3D Fault-Slip, Map3D Non-Linear or Map3D Visco-Plastic.

[Quadratic-Backfill in DD planes](#) can be used as a flow rule in DD planes in Map3D Fault-Slip, Map3D Non-Linear or Map3D Visco-Plastic.

[Equilbrated-Gouge in DD planes](#) can be used as a flow rule in DD planes in Map3D Fault-Slip, Map3D Non-Linear or Map3D Visco-Plastic.

[Yielding-Pillar in DD planes](#) can be used as a flow rule in DD planes in Map3D Fault-Slip, Map3D Non-Linear or Map3D Visco-Plastic.

In elastic analyses the failure criterion is used only for strength factor calculations and contour plotting and does not affect the analysis results.

In non-linear analyses (3D FF blocks in Map3D Non-Linear, 3D FF blocks in Map3D Visco-Plastic, and DD planes in Map3D Fault-Slip) the failure criterion is used as a flow rule to control yielding and non-linear deformations.

#### 4.3.12.4 Map3Di Setup

Sets up the Map3Di analysis.

Map3Di allows one to superimpose external field loading effects into the Map3D model. For details on this feature refer to [Map3Di](#).

When you check a Map3Di loading file for use you will be prompted to search for a file name, location. If the search is successful, the file will be checked.

The Map3Di loading file is specified in polyline file format. Refer to [Contour Plane Options](#) for details on generating a Map3Di loading file.

Comment lines must start with an asterisk "\*" in column 1.

2D planes are stored as a series of triangle or quadrilateral polylines as follows:

```
x1 y1 z1 3 values1
x2 y2 z2 2 values2
x3 y3 z3 2 values3
x4 y4 z4 2 values4
...
```

3D blocks are stored as a series of tetrahedral or hexahedral polylines as follows:

```
x1 y1 z1 3 values1
x2 y2 z2 2 values2
x3 y3 z3 2 values3
x4 y4 z4 2 values4
x5 y5 z5 1 values5
x6 y6 z6 1 values6
x7 y7 z7 1 values7
x8 y8 z8 1 values8
...
```

where  $x_i$   $y_i$   $z_i$  represent the coordinates of each point.

**3** indicates that this point is the beginning of a new polyline.

**2** indicates that this point forms part of the base of the block.

**1** indicates that this point forms part of the top of the block. This item is only used for definition of 3D block shapes.

Additional polylines are specified by repeating the sequence (i.e. starting a new polyline with the number **3**).

Any of the points can be repeated or skipped to specify triangular shaped sides or tetrahedrons.

**values<sub>i</sub>** specifies the magnitude of the field loading at the centre, or at each corner. If only **values<sub>1</sub>** is specified (i.e. **values<sub>2</sub>** ... are left blank) that value is applied uniformly across the entity.

If **values** are specified for all corners, the field loading is applied according to a higher order polynomial distribution.

For 2D surface triangles a linear distribution is used

$$a + b x + c y$$

For 2D quadrilaterals, the following distribution is used

$$a + b x + c y + d x y$$

For 3D block shapes, as many terms as possible of the distribution are used

$$a + b x + c y + d z + e x y + f y z + g z x + h x y z$$

The actual field loading effects can be specified in several ways.

### 2D Planes

2D planes define a Displacement Discontinuity with specified normal displacement (closure)  $\delta_n$ , and shear displacement (ride)  $\delta_s$ , such that **values<sub>i</sub>** can be specified either as

$$\delta_n \delta_s \text{ or } \delta_n \delta_{s1} \delta_{s2}$$

If only  $\delta_n \delta_s$  are specified, the shear displacement (ride) is applied parallel to the maximum in-plane shear stress for the 2D plane.

If all of  $\delta_n \delta_{s1} \delta_{s2}$  are specified, the shear displacement (ride) component  $\delta_{s1}$  is applied parallel to the first side (i.e. the side defined by  $x_1 y_1 z_1 - x_2 y_2 z_2$ ).  $\delta_{s2}$  is applied perpendicular to  $\delta_{s1}$  in the direction of the second side (i.e. the side defined by  $x_2 y_2 z_2 - x_3 y_3 z_3$ ).

Shear displacement (ride) and normal displacement (closure) are specified in displacement units (i.e. the same units as the geometry is specified in (metres).

The shear displacement (ride) and normal displacement (closure) may be determined from in situ or laboratory measurements of shear, closure and/or crack opening, or from another numerical modelling program such as a reservoir or hydraulic fracture simulator. These can also be estimated from seismic monitoring data.

### 3D Blocks

3D blocks define a zone with specified strain  $\epsilon$ , either as

$$\epsilon_1 \epsilon_2 \epsilon_3 \text{ or } \epsilon_{xx} \epsilon_{yy} \epsilon_{zz} \epsilon_{xy} \epsilon_{yz} \epsilon_{zx}$$

If only  $\varepsilon_1 \varepsilon_2 \varepsilon_3$  are specified, these principal strains are applied parallel to the principal stresses. The strains are used to determine the initial stress  $\sigma^\circ$  using

$$\sigma_1^\circ = [ (1-\nu) \varepsilon_1 + \nu ( \varepsilon_2 + \varepsilon_3 ) ] E / [ (1+\nu) (1-2\nu) ]$$

$$\sigma_2^\circ = [ (1-\nu) \varepsilon_2 + \nu ( \varepsilon_3 + \varepsilon_1 ) ] E / [ (1+\nu) (1-2\nu) ]$$

$$\sigma_3^\circ = [ (1-\nu) \varepsilon_3 + \nu ( \varepsilon_1 + \varepsilon_2 ) ] E / [ (1+\nu) (1-2\nu) ]$$

If all of  $\varepsilon_{xx} \varepsilon_{yy} \varepsilon_{zz} \varepsilon_{xy} \varepsilon_{yz} \varepsilon_{zx}$  are specified, these strains are applied as Cartesian components. The strains are used to determine the initial stress  $\sigma^\circ$  using

$$\sigma_{xx}^\circ = [ (1-\nu) \varepsilon_{xx} + \nu ( \varepsilon_{yy} + \varepsilon_{zz} ) ] E / [ (1+\nu) (1-2\nu) ]$$

$$\sigma_{yy}^\circ = [ (1-\nu) \varepsilon_{yy} + \nu ( \varepsilon_{zz} + \varepsilon_{xx} ) ] E / [ (1+\nu) (1-2\nu) ]$$

$$\sigma_{zz}^\circ = [ (1-\nu) \varepsilon_{zz} + \nu ( \varepsilon_{xx} + \varepsilon_{yy} ) ] E / [ (1+\nu) (1-2\nu) ]$$

$$\tau_{xy}^\circ = \varepsilon_{xy} E / (1+\nu)$$

$$\tau_{yz}^\circ = \varepsilon_{yz} E / (1+\nu)$$

$$\tau_{zx}^\circ = \varepsilon_{zx} E / (1+\nu)$$

Strains are specified in dimensionless strain units (i.e. 0.001 would specify 1000 micro strain).

$E$  and  $\nu$  represent respectively Young's modulus and Poisson's ratio. Map3D automatically determines which material the corner of the 3D block is located within and uses the corresponding material properties.

The strains may be determined from in situ or laboratory measurements of temperature or fluid pressure, or from another numerical modelling program such as a thermal analysis code. These can also be estimated from seismic monitoring data.

The strains that should be applied can be determined from the temperature through an expansion coefficient  $A$ , where the temperature change or fluid pressure change (from the background value) induces the initial stresses

$$\sigma_1^\circ = \sigma_2^\circ = \sigma_3^\circ = A \Delta T$$

For fluid flow problems the expansion coefficient  $A$ , should be set to unity (positive one) for saturated media. For thermal problems the expansion coefficient should be specified as a negative quantity given by

$$A = \alpha E / (1-2\nu)$$

where  $\alpha$  represents the coefficient of thermal expansion (i.e. the linear expansivity).

## Notes

This function must be set up before conducting the Map3D BEM analysis

[Analysis > BEM Analysis.](#)

 [CAD > Properties > Map3Di Setup > View](#) enables viewing of the Map3Di data.



#### 4.3.12.5 Model Information

Displays the current tally for the following model parameters:

- number of surfaces used to define the geometry,
- number of coordinates used to define the surfaces,
- number of mining steps.

The following parameters are only displayed after the discretization analysis ([Analysis > Discretization](#)) is complete:

- number of boundary elements,
- number of boundary nodes (only used for higher order elements ([Analysis > Options > Linear](#))),
- number of field points on user defined grids.

#### 4.3.13 Average Box

Calculates the weighted average value for all selected contour points.

You will be prompted to select the two corners of the window by picking each with a single mouse click. Only those contour points enclosed in the window will be included. To view the location of the actual contour points enable display of trajectories ([Plot > Options > Trajectories](#)). The contour points are located where the trajectories are drawn.

The averaging is done by multiplying each selected value by the area of its associated surface or grid patch, then summing these. This result is presented as the "Weighted Sum". The "Average" is determined by dividing the weighted sum by the total area.

All values are accumulated as vector components. Principal stresses are determined from the weighted mean of the Cartesian components. Displacement, flow and surface shear components are determined from the weighted mean of the vector components.

Note that for stresses, the "Weighted Sum" is actually the total force acting on the surface.

If you multiply by the shear modulus, the "Weighted Sum" of the plastic shear displacement (ride) is actually the Seismic Moment.

Complex polygonal shapes can be defined using [Plot > Polygon Box](#).

#### 4.3.14 Polygon Box

Calculates the weighted average value for all selected contour points. This function can also be activated using [View > Length](#).

You will be prompted to select a series of corners to define a closed polygon by picking each with a single mouse click:

- You must hold down the Shift-key so that multiple line segments can be selected.
- A closed polygonal shape is defined by closing the polyline by selecting the starting point.
- If you define a closed polygonal shape - those contour points enclosed in the polygon will be included in the averaging.
- The average routine will not function if you define an open polyline shape (by not selecting the starting point).
- To view the location of the actual contour points enable display of trajectories ([Plot > Options > Trajectories](#)). The contour points are located where the trajectories are drawn.

The averaging is done by multiplying each selected value by the area of its associated surface or grid patch, then summing these. This result is presented as the "Weighted Sum". The "Average" is determined by dividing the weighted sum by the total area.

All values are accumulated as vector components. Principal stresses are determined from the weighted mean of the Cartesian components. Displacement, flow and surface shear components are determined from the weighted mean of the vector components.

Note that for stresses, the "Weighted Sum" is actually the total force acting on the surface.

If you multiply by the shear modulus, the "Weighted Sum" of the plastic shear displacement (ride) is actually the Seismic Moment.

### 4.3.15 Excel Plot (Grids)

Plots specified grid components in Excel.

You must contour grid results in order to be able to select these for Excel plotting (e.g.  [Plot > Stress > s1 Major Principal Stress](#)).

The first parameter will be used as the x plot axis (i.e. abscissa).

Additional parameters will define the y plot axes (i.e. series or ordinates). Multiple y plot axes parameters can be specified.

Two types of Excel plots can be created:

- selected contour points.
- a series of points along the length of a polyline.

Excel plotting through Map3D is facilitated by the add-in routine Map3D.xla

- This routine is automatically loaded when Map3D starts Excel.
- You must allow this macro to run in order for the Map3D plotting routines to work.

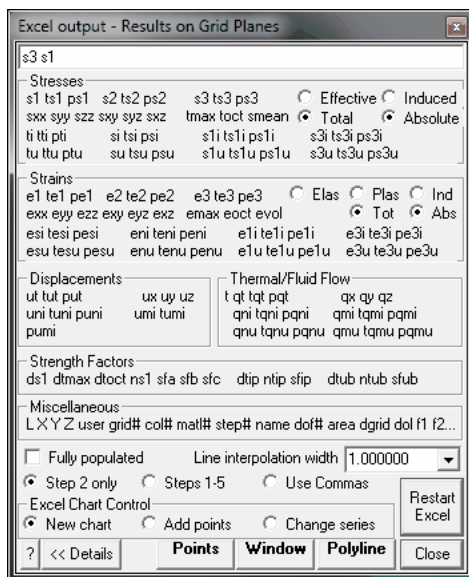

**Fully populated** Specifies that all missing contour points will be generated via interpolation.

- This option applies only to plotting of selected contour points (Points, Window and closed Polyline).
- This option does not apply to plotting on an open polyline.
- Map3D calculates results on a sparsely populated grid in order to save on analysis time.
- To view the location of the actual contour points enable display of trajectories ([Plot > Options > Trajectories](#)).
- With this option unchecked, only the actual contour points will be included in the plot.
- With this option checked, all missing contour points will be included in the plot.

**Line interpolation width** Specifies the desired spacing at which contour points will be generated via interpolation.

- This option applies only to plotting on an open polyline.
- This option does not apply to plotting of selected contour points.
- If the **Line interpolation width** is set to zero, only the ends of the open polyline will be plotted.
- Otherwise points will be generated along the polyline via interpolation at the specified **Line interpolation width**.

**Step # only** Specifies that the results for step # only will be dumped (# is the currently displayed loaded mining step).

**Steps 1-5** Specifies that the results for all steps will be dumped.

- Note that this can take a considerable amount of time for large datasets so you must be patient and wait for Map3D to cycle through all of the steps.

**Use Commas** Specifies that the results dumped to Excel will have commas in place of decimal points for the number format.

**Restart Excel** If Map3D loses communication with Excel, you must Restart Excel to re-establish communications.

**Points** activates graphical picking of individual points.

- The nearest point to the pick point will be plotted.
- To view the location of the actual contour points enable display of trajectories ([Plot > Options > Trajectories](#)). The contour points are located where the trajectories are drawn.

**Window** activates a rectangular pick window.

- You will be prompted to select the two corners of the window by picking each with a single mouse click.
- Only grid points enclosed within the window will be included in the plot.
- To view the location of the actual contour points enable display of trajectories ([Plot > Options > Trajectories](#)). The contour points are located where the trajectories are drawn.

**Polyline (closed)** activates a graphical pick polygon.

- You must hold down the Shift-key so that multiple line segments can be selected.
- A closed polygonal shape is defined by closing the polyline by selecting the starting point.
- If you define a closed polygonal shape - those contour points enclosed in the polygon will be plotted.
- If you define an open polyline shape - a series of points along the length of the polyline will be plotted.
- To view the location of the actual contour points enable display of trajectories ([Plot > Options >](#)

[Trajectories](#)). The contour points are located where the trajectories are drawn.

**Polyline (open)** activates a graphical pick polygon.

- You can select two points to define a single line segment.
- If you hold down the Shift-key multiple line segments can be selected.
- You can specify the desired spacing at which contour points will be generated via interpolation with using the [Line interpolation width](#) parameter.
- The user may find it useful to superimpose a regular grid on top of the contours ([Plot > Options > Grid Lines](#)) to assist in selecting the polyline location.
- If the [Line interpolation width](#) is set to zero, only the ends of the open polyline will be plotted.
- If you define an open polyline shape - a series of points along the length of the polyline will be plotted.
- If you define a closed polygonal shape - those contour points enclosed in the polygon will be plotted.

#### Excel Chart Control:

[New chart](#) - creates a new Excel chart.

[Extend existing chart](#) - adds data to the existing Excel chart. All plot parameters must be the same as those used previously.

[Change series](#) - changes or adds new series to an existing Excel chart. Only the first plot parameter must be the same. Additional plot parameters can be specified as desired.

#### Stresses:

[s1 ts1 ps1](#) major principal stress  $\sigma_1$  its trend and plunge.

[s2 ts2 ps2](#) intermediate principal stress  $\sigma_2$  its trend and plunge.

[s3 ts3 ps3](#) minor principal stress  $\sigma_3$  its trend and plunge.

[sxx syy szz sxy syz sxz](#) Cartesian stress components.

[tmax](#) maximum shear stress  $\tau_{max} = \frac{1}{2} (\sigma_1 - \sigma_3)$

[toct](#) octahedral shear stress  $\tau_{oct} = \frac{1}{3} [(\sigma_1 - \sigma_2)^2 + (\sigma_2 - \sigma_3)^2 + (\sigma_3 - \sigma_1)^2]^{1/2}$

[smean](#) mean stress  $\sigma_{mean} = \frac{1}{3} (\sigma_1 + \sigma_2 + \sigma_3)$

[ti tti pti](#) maximum shear stress in the grid plane, its trend and plunge.

[si tsi psi](#) normal stress in the grid plane, its trend and plunge.

[s1i ts1i ps1i](#) maximum stress tangential to the grid plane, its trend and plunge.

[s3i ts3i ps3i](#) minimum stress tangential to the grid plane, its trend and plunge.

[tu ttu ptu](#) maximum shear stress in the ubiquitous-plane, its trend and plunge.

[su tsu psu](#) stress normal to the ubiquitous plane, its trend and plunge.

[s1u ts1u ps1u](#) maximum stress tangential to the ubiquitous plane, its trend and plunge.

[s3u ts3u ps3u](#) minimum stress tangential to the ubiquitous plane, its trend and plunge.

The orientation of the ubiquitous-plane is specified in

 [Plot > Strength Factors > Ubiquitous Parameters](#)

[Effective/Total](#) effective stress or total stress components. These options are only used in [Map3D Thermal-Fluid Flow](#), as this code allows for calculation of steady state pore pressure distributions.

[Induced/Absolute](#) induced stress or absolute stress components (i.e. the stress without the pre-ming stress contribution).

#### Strains:

[e1 te1 pe1](#) major principal strain  $\epsilon_1$  its trend and plunge.

[e2 te2 pe2](#) intermediate principal strain  $\varepsilon_2$  its trend and plunge.  
[e3 te3 pe3](#) minor principal strain  $\varepsilon_3$  its trend and plunge.  
[exx eyy ezz exy eyz exz](#) Cartesian strain components.  
[emax](#) maximum shear strain  $\varepsilon_{\max} = \frac{1}{2} (\varepsilon_1 - \varepsilon_3)$   
[eoct](#) octahedral shear strain  $\varepsilon_{\text{oct}} = \frac{1}{3} [(\varepsilon_1 - \varepsilon_2)^2 + (\varepsilon_2 - \varepsilon_3)^2 + (\varepsilon_3 - \varepsilon_1)^2]^{1/2}$   
[evol](#) volumetric strain  $\varepsilon_{\text{vol}} = (\varepsilon_1 + \varepsilon_2 + \varepsilon_3)$   
[esi tesi pesi](#) maximum shear strain in the grid plane, its trend and plunge.  
[eni teni peni](#) normal strain in the grid plane, its trend and plunge.  
[e1i te1i pe1i](#) maximum strain tangential to the grid plane, its trend and plunge.  
[e3i te3i pe3i](#) minimum strain tangential to the grid plane, its trend and plunge.  
[esu tesu pesu](#) maximum shear strain in the ubiquitous-plane, its trend and plunge.  
[enu tenu penu](#) strain normal to the ubiquitous plane, its trend and plunge.  
[e1u te1u pe1u](#) maximum strain tangential to the ubiquitous plane, its trend and plunge.  
[e3u te3u pe3u](#) minimum strain tangential to the ubiquitous plane, its trend and plunge.  
[Elastic/Plastic/Total](#) elastic, plastic or total strain components. These options are only used in [Map3D Non-Linear](#), as this code allows for calculation of non-linear strains.  
[Induced/Absolute](#) induced strain or absolute strain components (i.e. the stress without the pre-mining stress contribution).

### Displacements:

[ut tut put](#) total displacement, its trend and plunge.  
[ux uy uz](#) Cartesian displacement components.  
[uni tuni puni](#) displacement normal to the grid plane, its trend and plunge.  
[umi tumi pumi](#) maximum displacement tangential to the grid plane, its trend and plunge.  
[unu tunu punu](#) displacement normal to the ubiquitous plane, its trend and plunge.  
[umu tumu pumu](#) maximum displacement tangential to the ubiquitous plane, its trend and plunge.

### Flow:

[t](#) temperature/head.  
[qt tqt pqt](#) total flow, its trend and plunge.  
[qx qy qz](#) Cartesian flow components.  
[qni tqni pqni](#) displacement normal to the grid plane, its trend and plunge.  
[qmi tqmi pqmi](#) maximum displacement tangential to the grid plane, its trend and plunge.  
[qnu tqnu pqnu](#) displacement normal to the ubiquitous plane, its trend and plunge.  
[qmu tqmu pqmu](#) maximum displacement tangential to the ubiquitous plane, its trend and plunge.

### Miscellaneous:

[L](#) Length along a line. Use the Polyline command to select the desired line.  
[X](#) coordinate value.  
[Y](#) coordinate value.  
[Z](#) coordinate value.  
[user](#) User defined value.  
[grid#](#) the number of the grid where the point is located.  
[col#](#) the colour number assigned to the grid where the point is located.  
[matl#](#) the number of the material within which the point is located. The host material is material number 1. In problems where multiple materials are used, results may be calculated in an alternate material zone.  
[step#](#) the mining step number.  
[name](#) the name assigned to the grid where the point is located.  
[dof#](#) a unique number specifying the storage location of the point in the Map3D database.

[dgrid](#) distance to the nearest surface from each grid point.

[dol](#) distance to the nearest grid *Dgrid* divided by the grid spacing *Lgrid*.

[f1 f2...](#) user defined material parameters. These can be defined using [Plot > Properties > Material Properties > User defined Parameters](#).

### 4.3.16 Excel Plot (Surfaces)

Plots specified surface components in Excel.

You must contour surface results in order to be able to select these for Excel plotting (e.g. [Plot > Surface Components > Ts Shear Stress](#)).

The first parameter will be used as the x plot axis (i.e. abscissa).

Additional parameters will define the y plot axes (i.e. series or ordinates). Multiple y plot axes parameters can be specified.

Two types of Excel plots can be created:

- selected contour points.
- a series of points along the length of a polyline.

Excel plotting through Map3D is facilitated by the add-in routine Map3D.xla

- This routine is automatically loaded when Map3D starts Excel.
- You must allow this macro to run in order for the Map3D plotting routines to work.

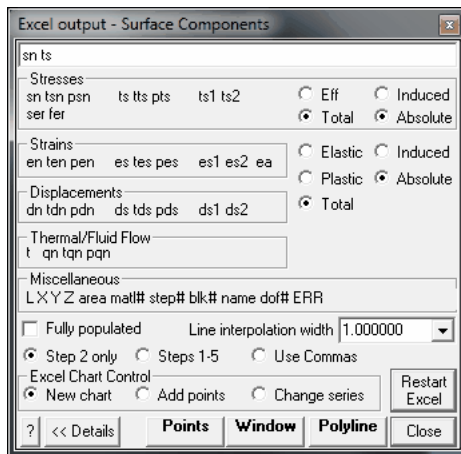

**Fully populated** Specifies that all missing contour points will be generated via interpolation.

- This option applies only to plotting of selected contour points (Points, Window and closed Polyline).
- This option does not apply to plotting on an open polyline.
- Map3D calculates results on a sparsely populated grid in order to save on analysis time.
- To view the location of the actual contour points enable display of trajectories ([Plot > Options > Trajectories](#)).
- With this option unchecked, only the actual contour points will be included in the plot.
- With this option checked, all missing contour points will be included in the plot.

**Line interpolation width** Specifies the desired spacing at which contour points will be generated via interpolation.

- This option applies only to plotting on an open polyline.
- This option does not apply to plotting of selected contour points.
- If the [Line interpolation width](#) is set to zero, only the ends of the open polyline will be plotted.
- Otherwise points will be generated along the polyline via interpolation at the specified [Line interpolation width](#).

**Step # only** Specifies that the results for step # only will be dumped (# is the currently displayed loaded mining step).

**Steps 1-5** Specifies that the results for all steps will be dumped.

- Note that this can take a considerable amount of time for large datasets so you must be patient and wait for Map3D to cycle through all of the steps.

**Use Commas** Specifies that the results dumped to Excel will have commas in place of decimal points for the number format.

**Restart Excel** If Map3D loses communication with Excel, you must Restart Excel to re-establish communications.

**Points** activates graphical picking of individual points.

- The nearest point to the pick point will be plotted.
- To view the location of the actual contour points enable display of trajectories ([Plot > Options > Trajectories](#)). The contour points are located where the trajectories are drawn.

**Window** activates a rectangular pick window.

- You will be prompted to select the two corners of the window by picking each with a single mouse click.
- Only grid points enclosed within the window will be included in the plot.
- To view the location of the actual contour points enable display of trajectories ([Plot > Options > Trajectories](#)). The contour points are located where the trajectories are drawn.

**Polyline (closed)** activates a graphical pick polygon.

- You must hold down the Shift-key so that multiple line segments can be selected.
- A closed polygonal shape is defined by closing the polyline by selecting the starting point.
- If you define a closed polygonal shape - those contour points enclosed in the polygon will be plotted.
- If you define an open polyline shape - a series of points along the length of the polyline will be plotted.
- To view the location of the actual contour points enable display of trajectories ([Plot > Options > Trajectories](#)). The contour points are located where the trajectories are drawn.

**Polyline (open)** activates a graphical pick polygon.

- You can select two points to define a single line segment.
- If you hold down the Shift-key multiple line segments can be selected.
- You can specify the desired spacing at which contour points will be generated via interpolation with using the [Line interpolation width](#) parameter.
- The user may find it useful to superimpose a regular grid on top of the contours ([View > Render > Grid Lines](#)) to assist in selecting the polyline location.
- If the [Line interpolation width](#) is set to zero, only the ends of the open polyline will be plotted.
- If you define an open polyline shape - a series of points along the length of the polyline will be

plotted.

- If you define a closed polygonal shape - those contour points enclosed in the polygon will be plotted.

### Excel Chart Control:

[New chart](#) - creates a new Excel chart.

[Extend existing chart](#) - adds data to the existing Excel chart. All plot parameters must be the same as those used previously.

[Change series](#) - changes or adds new series to an existing Excel chart. Only the first plot parameter must be the same. Additional plot parameters can be specified as desired.

### Stresses:

[sn tsn psn](#) stress normal to the surface, its trend and plunge.

[ts tts pts](#) maximum shear stress in the plane of the surface, its trend and plunge.

[ts1 ts2](#) shear stress components in the plane of the surface. [ts1](#) is parallel to the first side (i.e. the side defined by  $x_1 y_1 z_1 - x_2 y_2 z_2$ ). [ts2](#) is perpendicular to [ts1](#) in the direction of the second side (i.e. the side defined by  $x_2 y_2 z_2 - x_3 y_3 z_3$ ).

[ser](#) surface stress error. Iterative solvers function by determining the error in the current solution of each simultaneous equation, then reducing these errors by a process of successive approximations. This parameter indicates the error for each of the equations.

[fer](#) failure criterion error. This parameter is only used for non-linear creep analyses (including fault slip and 3D material non-linearity). This parameter should always be near zero unless some viscosity has been specified and the problem goes non-linear. In this latter case, viscous creep can allow stress states above the failure criterion, thus indicating a lack of static equilibrium. This parameter indicates the viscous stress for each of the equations.

[Effective/Total](#) – effective stress or total stress components. These options are only used in [Map3D Thermal-Fluid Flow](#), as this code allows for calculation of steady state pore pressure distributions.

[Induced/Absolute](#) induced stress or absolute stress components (i.e. the stress without the pre-mining stress contribution).

### Strains:

[en ten pen](#) strain in the direction normal to the surface, its trend and plunge. This parameter is only used for DD planes and is calculated as the normal displacement (closure) divided by the thickness.

[es tes pes](#) maximum shear strain in the plane of the surface, its trend and plunge. This parameter is only used for DD planes and is calculated as the shear displacement (ride) divided by the thickness.

[es1 es2](#) shear strain components in the plane of the surface. [es1](#) is parallel to the first side (i.e. the side defined by  $x_1 y_1 z_1 - x_2 y_2 z_2$ ). [es2](#) is perpendicular to [es1](#) in the direction of the second side (i.e. the side defined by  $x_2 y_2 z_2 - x_3 y_3 z_3$ ).

[Elastic/Plastic/Total](#) elastic, plastic or total strain components. These options are used for DD planes in [Map3D Fault-Slip](#), and also used in [Map3D Non-Linear](#), as this code allows for calculation of non-linear strains.

[Induced/Absolute](#) induced strain or absolute strain components (i.e. the stress without the pre-mining stress contribution).

### Displacements:

[dn tdn pdn](#) normal displacement (closure) in the direction normal to the surface, its trend and plunge. This parameter is only used for DD planes. Note that the elastic, plastic or total value can



be specified.

[ds tds pds](#) maximum shear displacement (ride) in the plane of the surface, its trend and plunge. This parameter is only used for DD planes. Note that the elastic, plastic or total value can be specified.

[ds1 ds2](#) shear displacement (ride) components in the plane of the surface. [ds1](#) is parallel to the first side (i.e. the side defined by  $x_1 y_1 z_1 - x_2 y_2 z_2$ ). [ds2](#) is perpendicular to [ds1](#) in the direction of the second side (i.e. the side defined by  $x_2 y_2 z_2 - x_3 y_3 z_3$ ).

#### Miscellaneous:

[L](#) Length along a line. Use the Polyline command to select the desired line.

[X](#) coordinate value.

[Y](#) coordinate value.

[Z](#) coordinate value.

[area](#) the area of the surface.

[matl#](#) the number of the material assigned to the surface.

[step#](#) the mining step number.

[blk#](#) the block number.

[name](#) the block name.

[dof#](#) the degree of freedom number.

[ERR](#) energy release rate plot.

## 4.4 Analysis

### 4.4.1 Analysis

Opens the Map3D Analysis dialogue box that controls all stress analysis functions.

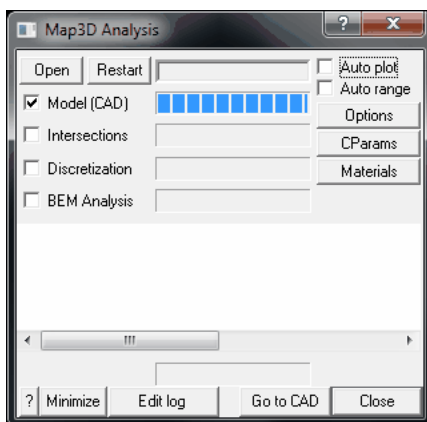

[Analysis > Open](#) Loads a model from a file.

[Analysis > Restart](#) Restarts an analysis that was aborted or interrupted by a power failure or operating system crash.

[Analysis > Model \(CAD\)](#) Loads a model from a file.

[Analysis > Intersections](#) Conducts contact and intersection analysis.

[Analysis > Discretization](#) Block and grid discretization.

[Analysis > BEM Analysis](#) Map3D BEM analysis.

[Analysis > Auto Plot](#) Automatically plot selected surface components as the Map3D BEM analysis proceeds.

[Analysis > Auto Range](#) Automatically modify the contour range as the Map3D BEM analysis proceeds.

[Analysis > Options](#) Sets up options that control various program operations.

[Analysis > Cparams](#) Modifies analysis control parameters during analysis.

[Analysis > Materials](#) Modifies material properties during analysis.

[Analysis > Minimize](#) Minimizes the graphics display during analysis.

[Analysis > Edit log](#) Edits the log file. The log file is a recording of all messages written to the message window.

[Analysis > Go to CAD](#) Go to the model building and editing stage.

[Analysis > Close](#) Close the dialogue box.

[Analysis > Spawn Results](#) Starts another instance of Map3D and loads the results for the first mining step. This is useful for viewing results of currently completed steps while subsequent steps are being analysed.

[Analysis > Suspend](#) Suspends/Pauses the currently running analysis.

[Analysis > Resume](#) Resumes the currently suspended analysis.

## 4.4.2 Analysis Options

Sets up options that control various program operations.

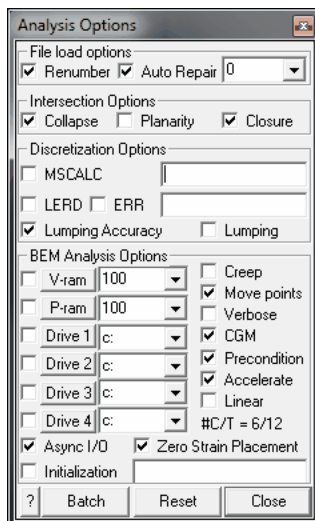

### File Load Options:

[Analysis > Options > Renumber](#) Renumber surfaces so the volume is positive (during file load).

[Analysis > Options > Auto Repair](#) Attempts to repair you model by filling gaps, deleting duplicates etc.(during file load).

**Intersection Options:**

[Analysis > Options > Collapse](#) Merge adjacent surfaces (during intersection analysis).

[Analysis > Options > Planarity](#) Subdivide non-planar quadrilaterals into triangles (during intersection analysis).

[Analysis > Options > Closure](#) Conducts closure and overlap checking, and resolves Boolean intersections (during intersection analysis).

**Discretization Options:**

[Analysis > Options > MSCALC](#) Calculate results at user defined points (during Map3D BEM analysis).

[Analysis > Options > LERD ERR](#) Calculate energy release rate and loading system stiffness (during Map3D BEM analysis).

[Analysis > Options > Lumping Accuracy](#)

[Analysis > Options > Lumping](#) Pre-calculate coefficient matrix size (during discretization analysis).

**Map3D BEM Analysis Options:**

[Analysis > Options > V-ram](#) Store part of the coefficient matrix in virtual RAM (during Map3D BEM analysis).

[Analysis > Options > P-ram](#) Store part of the coefficient matrix in physical RAM (during Map3D BEM analysis).

[Analysis > Options > Drive #](#) Specify scratch drives for coefficient matrix (during Map3D BEM analysis).

[Analysis > Options > Drive 2](#) Specify secondary scratch drive for coefficient matrix (during Map3D BEM analysis).

[Analysis > Options > Drive 3](#) Specify third scratch drive for coefficient matrix (during Map3D BEM analysis).

[Analysis > Options > Drive 4](#) Specify fourth scratch drive for coefficient matrix (during Map3D BEM analysis).

[Analysis > Options > Creep](#) Conduct elasto-visco-plastic creep analysis.

[Analysis > Options > Move Points](#) Move field points that are very close to boundary surfaces (during Map3D BEM analysis).

[Analysis > Options > Verbose](#) Write all solution vectors and field point results to the log file (during Map3D BEM analysis).

[Analysis > Options > CGM](#) Use the conjugate gradient solver (during Map3D BEM analysis).

[Analysis > Options > Precondition](#) Precondition the matrix (during Map3D BEM analysis).

[Analysis > Options > Accelerate](#) Use the matrix accelerator (during Map3D BEM analysis).

[Analysis > Options > Linear](#) Use higher order boundary elements (during Map3D BEM analysis).

[Analysis > Options > #C/T](#) = 6/12 indicates the number of cores/threads currently active.

[Analysis > Options > Async I/O](#) Use Windows asynchronous I/O routines (during Map3D BEM analysis).

[Analysis > Options > Zero Strain Placement](#)

[Analysis > Options > Initialization](#) Initialize the model so that the analysis continues from where a previous analysis completed.

#### Miscellaneous Options:

[Analysis > Options > Batch](#) Set up analysis batch queue.

[Analysis > Options > Reset](#)

## 4.5 CAD

### 4.5.1 Build

#### 4.5.1.1 Block

Builds a fully three-dimensional FF (Fictitious Force) type block. These are used for 3D excavations, alternate material zones (ore zones or dykes) and backfilled zones. The block surfaces will be further subdivided into boundary elements at a later stage in the program. In Map3D Non-Linear these zones can yield and behave non-linearly.

Multiple blocks can be combined to create complex 3D shapes. The FFLoop routine ( [CAD > Build > FF Loop](#)) can be used to extrude a series of 3D FF blocks from a floor plane or section, and can be used to interpolate between multiple floor planes or sections.

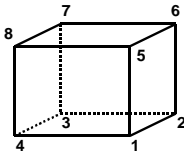

When the routine is initiated the user is prompted to select the first 4 corners that define one side (e.g. the bottom) of a 6-sided block. Once these are entered, the user is prompted for 4 additional corners (corners 5, 6, 7 and 8) that define the opposite side of the block (e.g. the top).

Corners can be ordered in either the clockwise or counter clockwise sense provided the top and bottom are entered in the same order with the top side corners 5, 6, 7 and 8 laying directly above the bottom side corners 1, 2, 3 and 4.

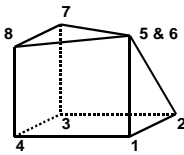

Any of the corners can be repeated to define 3 sided shapes and wedges.

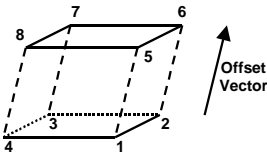

Once the base is defined (corners 1, 2, 3 and 4), the remaining corners (5, 6, 7 and 8) can be generated by offsetting or extruding

 [CAD > Build > Offset Remaining](#)

The coordinates of the corners can be typed in from the keyboard

 [CAD > Build > Enter Point](#)

selected by freehand drawing, picked from other entities (other blocks or construction lines) or digitized

 [CAD > Digitizer Setup > Activate](#)

A large variety of drawing tools are available to assist in visually selecting points from the model

 [CAD > Snap](#)

Corners can be unselected using

 [CAD > Build > Undo Point](#)

Corners can be reselected using

 [CAD > Build > Redo Point](#)

The block is considered to be complete when either the 8<sup>th</sup> corner is entered or the user selects .

Upon completion of block construction the user is prompted to enter the block properties. This allows you to specify the various parameters including the block colour and mining sequence.

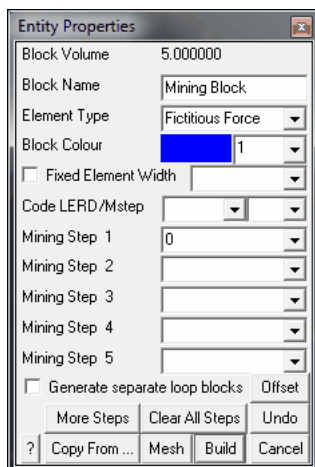

**Block Volume** - displays the volume of the block.

**Block Name** - specifies a descriptive name for the block.

**Element Type** - specifies the type of boundary element that will be used for the block.

- **Fictitious Force** - FF elements should be used for three-dimensional features such as excavations, alternate material zones, back-filled stopes etc.
- **Displacement Discontinuity** - DD elements should be used for tabular mining excavations, fractures and fault planes.
- Inactive elements can be used to display features that are to be included for visualization purposes only and not to be used for the actual stress analysis.

**Block Colour** - specifies the colour number that will be used to display the block.

Specifies the colour number that will be assigned to each button. A total of 10 colours are available for display. These are numbered respectively

1 through 10,  
11 through 20,  
21 through 30, etc.,

such that the same colour is displayed for numbers

1, 11, 21...,  
2, 22, 32...,  
3, 23, 33..., etc.

**Fixed Element Width** - specifies the user defined element width.

This parameter can be used to force uniform discretization on selected entities. Extreme caution should be used in specifying this value since a small value can easily lead to enormous problem size.

In general this option should not be used (unchecked) and discretization should be left to the [AL](#) and [AG](#) parameters. These latter parameters will concentrate elements only where analysis results are requested thus optimizing the use of elements and minimizing problem size. For further discussion refer to

[CAD > Properties Control Parameters](#)

This parameter can also be used to avoid making surfaces with sides larger than this during the intersection analysis. Any surfaces whose side length exceeds this dimension will not be collapsed

[Analysis > Options > Collapse](#)

During the discretization process, any surface whose side length exceeds this dimension will be subdivided to prevent surfaces having sides larger than this.

For an example of the use of this parameter refer to [Tabular Mining Example](#)

**Matl\_Code LERD/MStep** - specifies the material code that will be substituted into the block for the LERD/LSS calculation.

The first box is for the material code.

The second box is to specify the mining step number when the calculation is to be done. If this box is left blank then the LERD calculation will be done for all steps.

[Analysis > Options > LERD/LSS.](#)

**Mining Step n** - specifies the material code that will be used for this block in mining step n. In the above example, the block is non-existent at step 1, has material #2 (Ore) inserted in it at step 2, it is excavated at step 3 (material code 0 means to excavate), and finally at step 4 material #5 (backfill) is inserted. When you use a positive material number, the material is placed into the block at the specified initial stress state, and is then allowed to deform according to the elastic/plastic properties you have set for that material number. When you use a negative material number, the material is placed into the block at the specified initial stress state, but the stress state is held at these values regardless of the deformations, thereby providing a stress boundary condition.

**More Steps** - allows specification of additional mining steps.

**Clear All Steps** - clears all mining steps (1-100).

**Undo** - unselects the last point entered and returns to the block construction routine

 [CAD > Build > Undo Point](#)

**Copy From...** - allows you to select another block to copy the entity properties from.

**Mesh** - builds the block with surfaces subdivided into smaller parts at the specified block grid spacing.

**Build** - completes block construction and enters the block into the model database.

Once you have completed this operation you have one last chance to undo this and remove this block from the model database by selecting

 [CAD > Build > Undo Build](#)

**Cancel** aborts block construction.

Note that it is possible to create zero volume blocks for example by specifying a zero length offset vector. This allows users to construct individual FF surfaces if desired. While this is permissible it is not recommended as this can lead to unclosed volumes.

FF blocks can be collapsed into DD planes at any time simply by changing the element type

 [CAD > Edit > Entity Properties](#)

In this case the base of the block (the side defined by corners 1, 2, 3 and 4) will become the DD plane and the remainder of the block sides will be discarded.

Notes:

Different colour numbers should be used to represent logical groupings of blocks (e.g. for different levels, sections or logical mining units such as development, stoping etc.). These colours are user definable

[Tools > Custom Colours](#)

Any blocks with the same colour number will be automatically combined into single complex shapes by Map3D.

Since it is easy to toggle on and off the display of specific block colour numbers

 [View > Hide Block Colours](#)

This provides an efficient method to work with complex model data.

For discussion on model building aspects refer to:

[Model Building and Editing](#)

For tutorials on model building refer to:

[Model Building Tutorials](#)

Pressing the space-bar automatically activates the last build function that was used.

#### 4.5.1.2 FF Loop

Builds fully three-dimensional FF (Fictitious Force) type blocks. These are used for 3D excavations, alternate material zones (ore zones or dykes) and backfilled zones. The block surfaces will be further subdivided into boundary elements at a later stage in the program. In Map3D Non-Linear these zones can yield and behave non-linearly.

A few examples demonstrating this routine can be found under [Model Building Tutorials](#). Refer specifically to

- [FFLoop Drift Example](#)
- [FFLoop Stope Example](#)
- [Bulk Mining Example](#)

### FFLoops

When the routine is initiated the user is prompted to select the corners that define the perimeter of a series of floor plans or sections. The direction you traverse each loop is not relevant. As many loops as desired can be defined simultaneously. The number of points does not have to be the same on each loop. The starting and end points on each loop (e.g. points 1 and 11 on the first loop, and points 12 and 22 on the second) must be at the same location to define a series of closed loops.

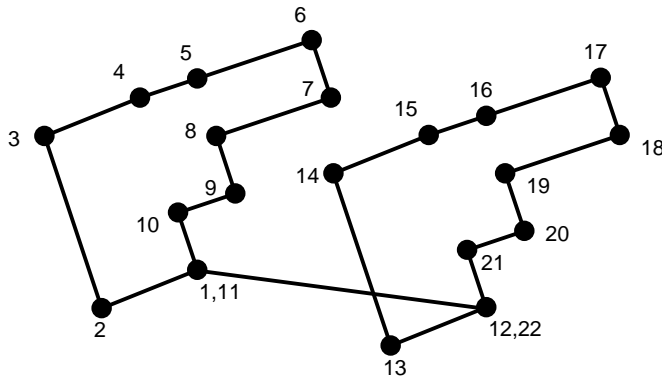

### Trace

These points can be selected one at a time, or all points along a construction line segment can be selected using the  [CAD > Snap > Trace CLoop](#) snap function.

### Close

The FFLoop routine is considered to be complete when one of the following two conditions is met:

- the user selects the final loop point (i.e. point #22) a third time
-  [CAD > Build > FFLoop](#)

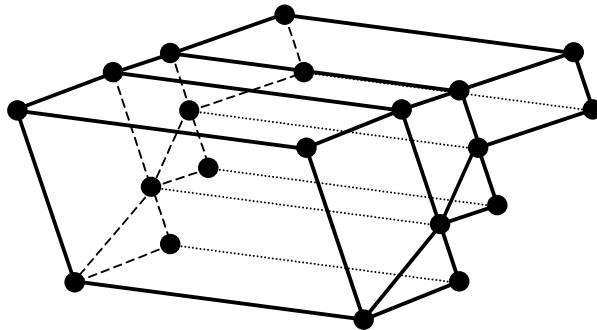

The loops will then be subdivided into a series of 3 or 4 sided FF elements. These surfaces will be



further subdivided into boundary elements at a later stage in the program. The routine that does this subdivision searches for corners that are near one another, so the user should take care to define the loop such that the connections are straightforward. In the above example it is recommended that points 4 and 5 be selected or generated.

### Guide Lines

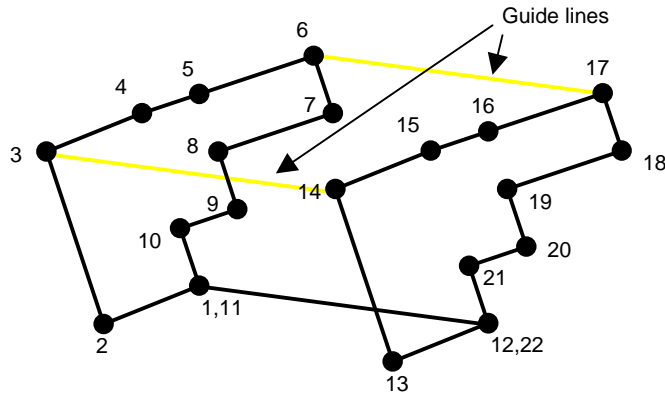

For more complex shapes, guide lines (shown in yellow) can be defined, that force the sides to be subdivided along these lines. These are simply defined as construction lines. For an example refer to <https://www.map3d.com/ffloop.htm>. Guide lines must not intersect or cross one another.

### Extrusion using Offset

Once the first closed loop has been entered, the remaining points can be generated by offsetting the remaining points using  [CAD > Build > Offset Remaining](#)

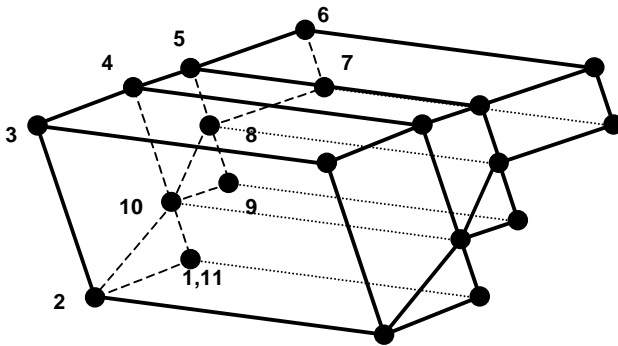

### Miscellaneous

The coordinates of the corners can be typed in from the keyboard

 [CAD > Build > Enter Point](#)

selected by freehand drawing, picked from other entities (other blocks or construction lines) or digitized

 [CAD > Digitizer Setup > Activate](#)

A large variety of drawing tools are available to assist in visually selecting points from the model

 [CAD > Snap](#)

Corners can be unselected using

 [CAD > Build > Undo Point](#)

Corners can be reselected using

 [CAD > Build > Redo Point](#)

Upon completion of block construction the user is prompted to enter the block properties. This allows you to specify the various parameters including the block colour and mining sequence.

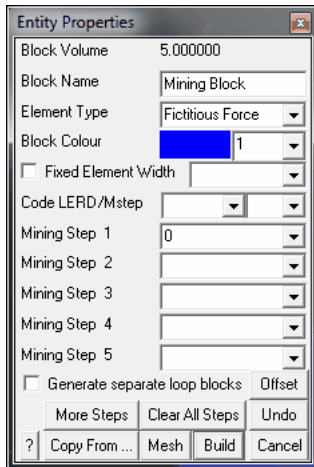

**Block Volume** - displays the volume of the block.

**Block Name** - specifies a descriptive name for the block.

**Element Type** - specifies the type of boundary element that will be used for the block.

- **Fictitious Force** - FF elements should be used for three-dimensional features such as excavations, alternate material zones, back-filled stopes etc.
- **Displacement Discontinuity** - DD elements should be used for tabular mining excavations, fractures and fault planes.
- Inactive elements can be used to display features that are to be included for visualization purposes only and not to be used for the actual stress analysis.

**Block Colour** - specifies the colour number that will be used to display the block.

Specifies the colour number that will be assigned to each button. A total of 10 colours are available for display. These are numbered respectively

1 through 10,  
11 through 20,  
21 through 30, etc.,

such that the same colour is displayed for numbers

1, 11, 21...,  
2, 22, 32...,  
3, 23, 33..., etc.

**Fixed Element Width** - specifies the user defined element width.

This parameter can be used to force uniform discretization on selected entities. Extreme caution should be used in specifying this value since a small value can easily lead to enormous problem size.

In general this option should not be used (unchecked) and discretization should be left to the [AL](#) and [AG](#) parameters. These latter parameters will concentrate elements only where analysis results are requested thus optimizing the use of elements and minimizing problem size. For further discussion refer to

[CAD > Properties Control Parameters](#)

This parameter can also be used to avoid making surfaces with sides larger than this during the intersection analysis. Any surfaces whose side length exceeds this dimension will not be collapsed

[Analysis > Options > Collapse](#)

During the discretization process, any surface whose side length exceeds this dimension will be subdivided to prevent surfaces having sides larger than this.

For an example of the use of this parameter refer to [Tabular Mining Example](#)

**Matl\_Code LERD/MStep** - specifies the material code that will be substituted into the block for the LERD/LSS calculation.

The first box is for the material code.

The second box is to specify the mining step number when the calculation is to be done. If this box is left blank then the LERD calculation will be done for all steps.

[Analysis > Options > LERD/LSS.](#)

**Mining Step n** - specifies the material code that will be used for this block in mining step n. In the above example, the block is non-existent at step 1, has material #2 (Ore) inserted in it at step 2, it is excavated at step 3 (material code 0 means to excavate), and finally at step 4 material #5 (backfill) is inserted. When you use a positive material number, the material is placed into the block at the specified initial stress state, and is then allowed to deform according to the elastic/plastic properties you have set for that material number. When you use a negative material number, the material is placed into the block at the specified initial stress state, but the stress state is held at these values regardless of the deformations, thereby providing a stress boundary condition.

**Generate Separate Loop Blocks** - if you are building multi-loop blocks, you can specify whether or not interfaces will be created between each block so that each block can be treated as a separate mining unit.

If you do not specify this option then a single large block will be created.

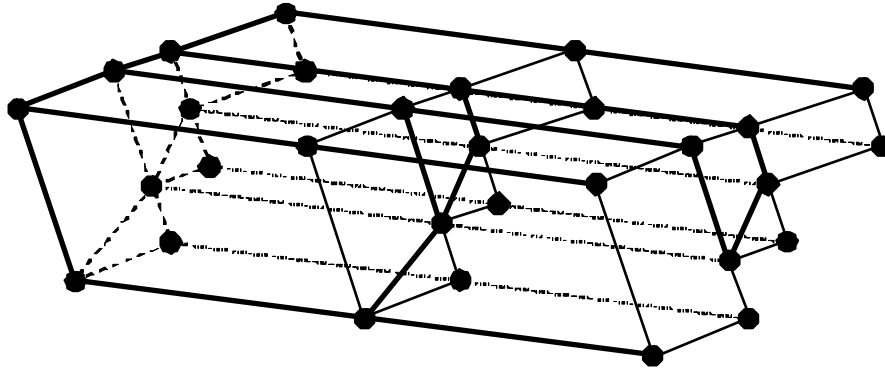

**Offset** - allows you to offset a planar loop to extrude the block into a 3D shape.  
This operation can also be done using [Extrude/Offset Remaining](#).

**More Steps** - allows specification of additional mining steps.

**Clear All Steps** - clears all mining steps (1-100).

**Undo** - unselects the last point entered and returns to the block construction routine

 [CAD > Build > Undo Point](#)

**Copy From...** - allows you to select another block to copy the entity properties from.

**Mesh** - builds the block with surfaces subdivided into smaller parts at the specified block grid spacing.

**Build** - completes block construction and enters the block into the model database.

Once you have completed this operation you have one last chance to undo this and remove this block from the model database by selecting

 [CAD > Build > Undo Build](#)

**Cancel** aborts block construction.

Note that it is possible to create zero volume blocks for example by specifying a zero length offset vector. This allows users to construct individual FF surfaces if desired. While this is permissible it is not recommended as this can lead to unclosed volumes.

FF blocks can be collapsed into DD planes at any time simply by changing the element type

 [CAD > Edit > Entity Properties](#)

In this case the base of the block (the side defined by corners 1, 2, 3 and 4) will become the DD plane and the remainder of the block sides will be discarded.

Notes:

Different colour numbers should be used to represent logical groupings of blocks (e.g. for different levels, sections or logical mining units such as development, stoping etc.). These colours are user definable

[Tools > Custom Colours](#)

Any blocks with the same colour number will be automatically combined into single complex shapes by Map3D.

Since it is easy to toggle on and off the display of specific block colour numbers

 [View > Hide Block Colours](#)

This provides an efficient method to work with complex model data.

For discussion on model building aspects refer to:

[Model Building and Editing](#)

For tutorials on model building refer to:

[Model Building Tutorials](#)

Pressing the space-bar automatically activates the last build function that was used.

#### 4.5.1.3 DD Loop

Builds DD (Displacement Discontinuity) type block. These are used for tabular mining, thin seams or fault planes. In all versions of Map3D these zones can yield and behave non-linearly. Multiple DD's can be combined to create complex offset and rolling shapes.

A few examples demonstrating this routine can be found under [Model Building Tutorials](#). Refer specifically to

- [DDLooP Pillar Example](#)
- [Tabular Mining Example](#)

#### DDLooP

When the routine is initiated the user is prompted to select a series of loops that define the perimeter of the desired zones. The direction you traverse each loop is not relevant. The starting and end point of each loop (e.g. points 1 and 11, or 12 and 22) must be at the same location to define closed loops.

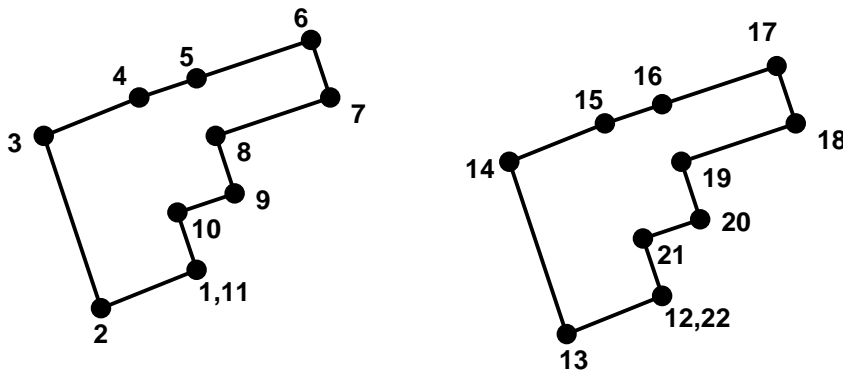

#### Trace

These points can be selected one at a time, or all points along a construction line segment can be selected using the  [CAD > Snap > Trace CLoop](#) snap function.

#### Close

The DDLooP routine is considered to be complete when one of the following two conditions is met:

- the user selects the final loop point (i.e. point #12,22) a third time
-  [CAD > Build > DDLoop](#)

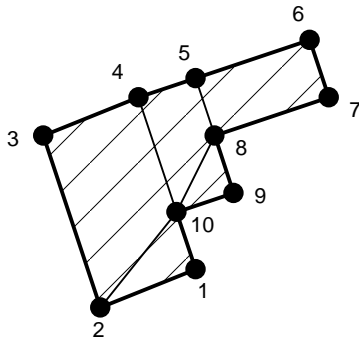

The loops will then be subdivided into a series of 3 or 4 sided DD elements. These surfaces will be further subdivided into boundary elements at a later stage in the program. The routine that does this subdivision searches for corners that are near one another, so the user should take care to define the loop such that the connections are straightforward. In the above example it is recommended that points 4 and 5 be selected or generated.

The Mesh build function (see below) can be used to build the block with surfaces subdivided into smaller parts at the specified block grid spacing. This routine generates interior points as required to maintain well shaped elements.

### Guide Lines

Multiple interior zones can be traced simultaneously by defining guide lines (shown in yellow).

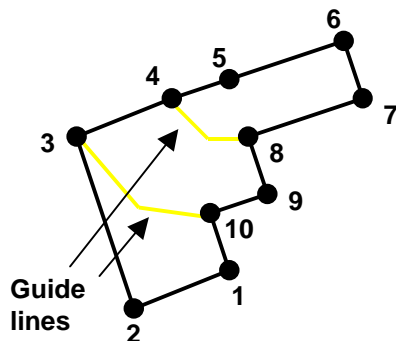

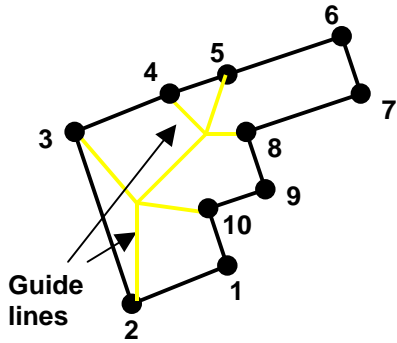

These are simply defined as construction lines. For an example refer to <https://www.map3d.com/t.htm>. Guide lines must traverse the perimeter loop from edge to edge. Multiple guide lines can be defined that intersect one another thus defining multiple zones.

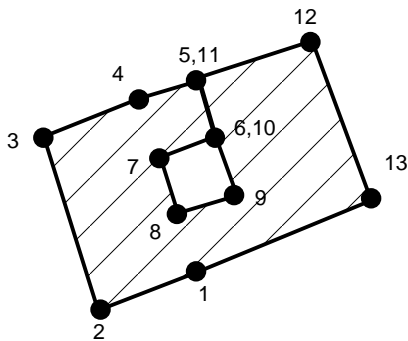

### Interior Zones

Multiple interior zones (e.g. pillars) can be defined by tracing around their periphery as shown below. The direction you traverse the interior zone is not relevant. As many interior zones as desired can be defined in this way.



Alternatively these interior zones may be conveniently constructed by tracing around the outer perimeter ( [CAD > Snap > Trace CLoop](#)) and using guide lines to define the desired interior shapes.

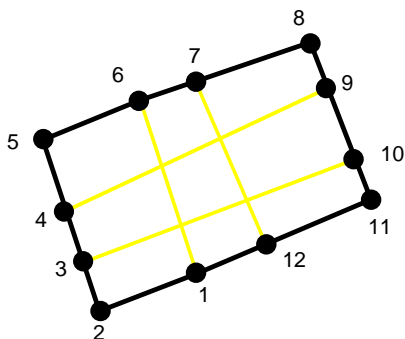

### Extrusion using Offset

Once at least two points have been entered, the remaining points can be generated by offsetting the remaining points using  [CAD > Build > Offset Remaining](#)

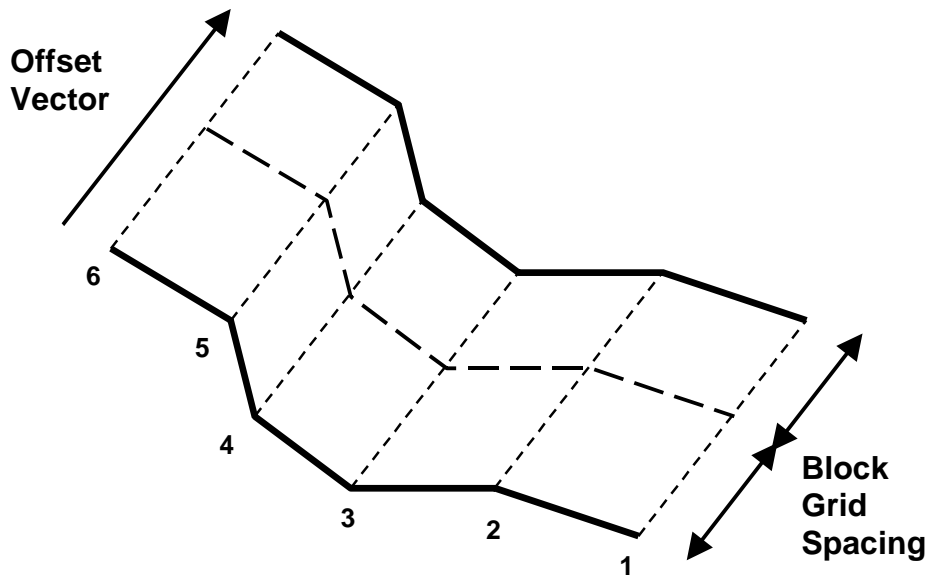

Note also that DD elements can be extruded into FF zones simply by changing the element type from DD to FF.

### Miscellaneous

The coordinates of the corners can be typed in from the keyboard

 [CAD > Build > Enter Point](#)

selected by freehand drawing, picked from other entities (other blocks or construction lines) or digitized

 [CAD > Digitizer Setup > Activate](#)

A large variety of drawing tools are available to assist in visually selecting points from the model

 [CAD > Snap](#)

Corners can be unselected using

 [CAD > Build > Undo Point](#)

Corners can be reselected using

 [CAD > Build > Redo Point](#)

Upon completion of block construction the user is prompted to enter the block properties. This allows you to specify the various parameters including the block colour and mining sequence.



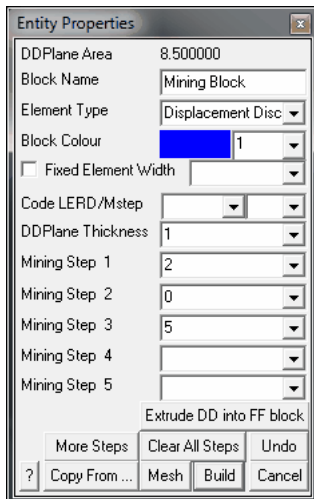

**DDPlane Area** - displays the combined area of all of the DDPlanes included in the DDLoop.

**Block Name** - specifies a descriptive name for the block.

**Element Type** - specifies the type of boundary element that will be used for the block.

- **Displacement Discontinuity** - DD type elements should be used for tabular mining excavations, fractures and fault planes.
- **Fictitious Force** - FF type elements should be used. For three-dimensional features such as excavations, alternate material zones, back-filled stopes etc.
- **Inactive elements** can be used to display features that are to be included for visualization purposes only and not to be used for the actual stress analysis.

**Block Colour** - specifies the colour number that will be used to display the block.

Specifies the colour number that will be assigned to each button. A total of 10 colours are available for display. These are numbered respectively

1 through 10,  
11 through 20,  
21 through 30, etc.,

such that the same colour is displayed for numbers

1, 11, 21...,  
2, 22, 32...,  
3, 23, 33..., etc.

**Fixed Element Width** - specifies the user defined element width.

This parameter can be used to force uniform discretization on selected entities. Extreme caution should be used in specifying this value since a small value can easily lead to enormous problem size.

In general this option should not be used (unchecked) and discretization should be left to the [AL](#) and [AG](#) parameters. These latter parameters will concentrate elements only where analysis results are requested thus optimizing the use of elements and minimizing problem size. For further discussion refer to

[CAD > Properties Control Parameters](#)

This parameter can also be used to avoid making surfaces with sides larger than this during the intersection analysis. Any surfaces whose side length exceeds this dimension will not be collapsed

[Analysis > Options > Collapse](#)

During the discretization process, any surface whose side length exceeds this dimension will be subdivided to prevent surfaces having sides larger than this.

For an example of the use of this parameter refer to [Tabular Mining Example](#)

**Matl\_Code LERD/MStep** - specifies the material code that will be substituted into the block for the LERD/LSS calculation.

The first box is for the material code.

The second box is to specify the mining step number when the calculation is to be done. If this box is left blank then the LERD calculation will be done for all steps.

[Analysis > Options > LERD/LSS.](#)

[Analysis > Options > LERD/LSS](#)

**DDPlane Thickness** - specifies the thickness of the material inserted into the DD element (i.e. fault gouge, seam width, mining width or pillar height).

Normal displacement (closure) of the feature when in-filled will be limited to this thickness. Also, the normal displacement (closure) and shear displacement (ride) are divided by the thickness to determine the strain occurring in the in-filling material

[Fault-Gouge in DD planes](#)

[Backfill-Hyperbolic in DD planes](#)

[Equilibrated-Gouge in DD planes](#)

[Mohr-Coulomb in DD planes](#)

This parameter should be specified in the same units used to specify the coordinate positions (e.g. metres or feet).

**Mining Step n** - specifies the material code that will be used for this block in mining step n. In the above example, the block is non-existent at step 1, has material #2 (Ore) inserted in it at step 2, it is excavated at step 3 (material code 0 means to excavate), and finally at step 4 material #5 (backfill) is inserted. When you use a positive material number, the material is placed into the block at the specified initial stress state, and is then allowed to deform according to the elastic/plastic properties you have set for that material number. When you use a negative material number, the material is placed into the block at the specified initial stress state, but the stress state is held at these values regardless of the deformations, thereby providing a stress boundary condition.

**Extrude DD into FF blocks** - allows you to extrude a DD plane into an FF block. You will be prompted for the extrusion vector

**More Steps** - allows specification of additional mining steps.

**Clear All Steps** - clears all mining steps (1-100).

**Undo** - unselects the last point entered and returns to the block construction routine

 [CAD > Build > Undo Point](#)

**Copy From...** - allows you to select another block to copy the entity properties from.

**Mesh** - builds the block with surfaces subdivided into smaller parts at the specified block grid spacing. This routine generates interior points as required to maintain good shaped elements.

**Build** - completes block construction and enters the block into the model database.

Once you have completed this operation you have one last chance to undo this and remove this block from the model database by selecting

 [CAD > Build > Undo Build](#)

**Cancel** aborts block construction.

Note that it is possible to create zero volume blocks for example by specifying a zero length offset vector. This allows users to construct individual FF surfaces if desired. While this is permissible it is not recommended as this can lead to unclosed volumes.

DD blocks can be extruded into 3D FF blocks at any time simply by changing the element type

 [CAD > Edit > Entity Properties](#)

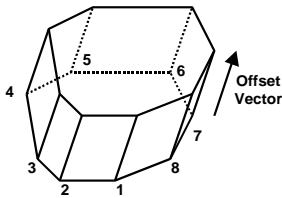

In this case corners 1 through 8 define the base of the block. The top and sides are automatically generated during the extrusion process.

Note that it is possible to create zero volume blocks for example by specifying a zero length offset vector. This allows users to construct individual FF surfaces if desired. While this is permissible it is not recommended as this can lead to unclosed volumes.

Notes:

Different colour numbers should be used to represent logical groupings of blocks (e.g. for different levels, sections or logical mining units such as development, stoping etc.). These colours are user definable

[Tools > Custom Colours](#)

Any blocks with the same colour number will be automatically combined into single complex shapes by Map3D.

Since it is easy to toggle on and off the display of specific block colour numbers

 [View > Hide Block Colours](#)

This provides an efficient method to work with complex model data.

For discussion on model building aspects refer to:

[Model Building and Editing](#)

For tutorials on model building refer to:

[Model Building Tutorials](#)

Pressing the space-bar automatically activates the last build function that was used.

#### 4.5.1.4 Grid Plane

Builds a grid plane. Analysis results (stresses, strains and displacements) are calculated on these grid planes. Each grid plane will be further subdivided at a later stage in the program (line grids can be created using  [CAD > Build > Grid Line](#)).

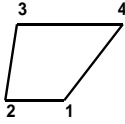

When the routine is initiated the user is prompted to select 4 corners that define the perimeter of the grid plane. The grid plane is considered to be complete when either the 4<sup>th</sup> corner is selected or the user selects

 [CAD > Build > Build](#)

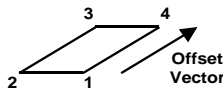

Once at least two points have been entered, the remaining points can be generated by offsetting

 [CAD > Build > Offset Remaining](#)

The coordinates of the corners can be typed in from the keyboard

 [CAD > Build > Enter Point](#)

selected by freehand drawing, picked from other entities (other blocks or construction lines) or digitized

 [CAD > Digitizer Setup > Activate](#)

A large variety of drawing tools are available to assist in visually selecting points from the model

 [CAD > Snap](#)

Corners can be unselected using

 [CAD > Build > Undo Point](#)

Corners can be reselected using

 [CAD > Build > Redo Point](#)

Upon completion of grid plane construction the user is prompted to enter the properties. This allows you to specify a name for the grid plane.

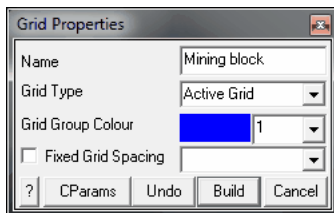

**Name** - specifies a descriptive name for the grid.

**Grid Type** - specifies whether you want the grid to be active (used in the stress analysis) or inactive (not used in the stress analysis).

**Fixed Grid Spacing** - specifies the user grid spacing.

This parameter can be used to force uniform discretization on selected grids. Extreme caution should be used in specifying this value since a small value can easily lead to enormous problem size.

In general this option should not be used (unchecked) and discretization should be left to the [AG](#) parameter. This latter parameter will concentrate elements only where analysis results are requested thus optimizing the use of elements and minimizing problem size.

[CAD > Properties Control Parameters](#)

**Undo** - unselects the last point entered and returns to the grid construction routine

 [CAD > Build > Undo Point](#)

**Build** - completes grid construction and enters the block into the model database.

Once you have completed this operation you have one last chance to undo this and remove this grid from the model database by selecting

 [CAD > Build > Undo Build](#)

**Cancel** - aborts grid construction.

For examples on the use of field point grid planes refer to:

[Model Building Tutorials](#)

Pressing the space-bar automatically activates the last build function that was used.

#### 4.5.1.5 Grid Line

Builds a grid line. Analysis results (stresses, strains and displacements) are calculated on these grid lines. Each grid line will be further subdivided at a later stage in the program (grid planes can be created using  [CAD > Build > Grid Plane](#)).

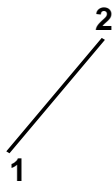

When the routine is initiated the user is prompted to select 2 corners that define the ends of the grid line. The grid line is considered to be complete when either the 2nd corner is selected or the user selects

 [CAD > Build > Build](#)

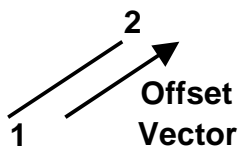

After the first point has been entered, the remaining point can be generated by offsetting

 [CAD > Build > Offset Remaining](#)

The coordinates of the corners can be typed in from the keyboard

 [CAD > Build > Enter Point](#)

selected by freehand drawing, picked from other entities (other blocks or construction lines) or digitized

 [CAD > Digitizer Setup > Activate](#)

A large variety of drawing tools are available to assist in visually selecting points from the model

 [CAD > Snap](#)

Corners can be unselected using

 [CAD > Build > Undo Point](#)

Corners can be reselected using

 [CAD > Build > Redo Point](#)

Upon completion of grid plane construction the user is prompted to enter the properties. This allows you to specify a name for the grid line.

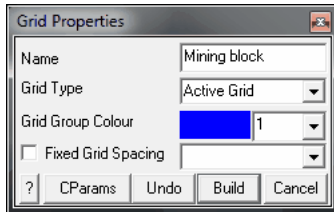

**Name** - specifies a descriptive name for the grid.

**Grid Type** - specifies whether you want the grid to be active (used in the stress analysis) or inactive (not used in the stress analysis).

**Fixed Grid Spacing** - specifies the user grid spacing.

This parameter can be used to force uniform discretization on selected grids. Extreme caution should be used in specifying this value since a small value can easily lead to enormous problem size.

In general this option should not be used (unchecked) and discretization should be left to the **AG** parameter. This latter parameter will concentrate elements only where analysis results are requested thus optimizing the use of elements and minimizing problem size.

[CAD > Properties Control Parameters](#)

**Undo** - unselects the last point entered and returns to the grid construction routine

 [CAD > Build > Undo Point](#)

**Build** - completes grid construction and enters the block into the model database.

Once you have completed this operation you have one last chance to undo this and remove this grid from the model database by selecting

 [CAD > Build > Undo Build](#)

**Cancel** - aborts grid construction.

For examples on the use of field point grid planes refer to:

### [Model Building Tutorials](#)

Pressing the space-bar automatically activates the last build function that was used.

#### 4.5.1.6 Construction Lines

Builds construction lines. These are meant to represent the mining outlines and are used as aids for building your model. Construction lines are generally digitized from drawings or imported from other CAD packages.

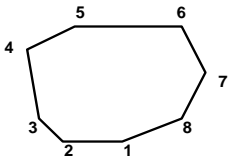

When the routine is initiated the user is prompted to select a series of corners that define the perimeter of the desired zone. The construction line is considered to be complete when either the 1st corner is repeated or the user selects

 [CAD > Build > Build](#)

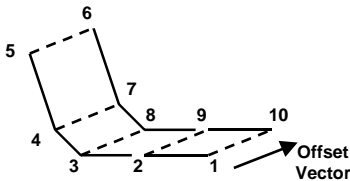

Once at least two points have been entered, the remaining points can be generated by offsetting

 [CAD > Build > Offset Remaining](#)

The coordinates of the corners can be typed in from the keyboard

 [CAD > Build > Enter Point](#)

selected by freehand drawing, picked from other entities (other blocks or construction lines) or digitized

 [CAD > Digitizer Setup > Activate](#)

A large variety of drawing tools are available to assist in visually selecting points from the model

 [CAD > Snap](#)

Corners can be unselected using

 [CAD > Build > Undo Point](#)

Corners can be reselected using

 [CAD > Build > Redo Point](#)

Upon completion of block construction the user is prompted to enter the properties. This allows you to specify the colour of the construction line.

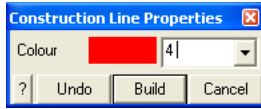

**Colour** - specifies the colour number that will be used to display the construction line. A total of 10 colours are available for display. These are numbered respectively

1 through 10,  
11 through 20,  
21 through 30, etc.,

such that the same colour is displayed for numbers

1, 11, 21...,  
2, 22, 32...,  
3, 23, 33..., etc.

**Undo** - unselects the last point entered and returns to the construction line grid building routine.

 [CAD > Build > Undo Point](#)

**Build** - completes grid construction and enters the block into the model database.

Once you have completed this operation you have one last chance to undo this and remove this grid from the model database by selecting

 [CAD > Build > Undo Build](#)

**Cancel** - aborts line construction.

Notes

Different colour numbers should be used to represent logical groupings of construction lines (e.g. for different levels, sections or logical mining units such as development, stoping etc.). These colours are user definable

[Tools > Custom Colours](#)

Since it is easy to toggle on and off the display of specific construction line colour numbers

 [View > Hide Block Colours](#)

This provides an efficient method to work with complex construction line data.

For examples on the use of construction lines in model building refer to:

[Model Building Tutorials](#)

Pressing the space-bar automatically activates the last build function that was used.

#### 4.5.1.7 Build

Completes construction of the following entities by filling in default values for all remaining points:

 [CAD > Build > Block](#)

 [CAD > Build > FF Loop](#)

 [CAD > Build > DD Loop](#)

 [CAD > Build > Grid Plane](#)



 [CAD > Build > Grid Line](#)

 [CAD > Build > Construction Lines](#)

Upon completion of block construction the user is prompted to enter the block properties

 [CAD > Edit > Entity Properties](#)

This allows you to specify the various parameters including the block colour and mining sequence.

Pressing the space-bar automatically activates the last build function that was used.

#### 4.5.1.8 Enter Point

The coordinates of the corners can be typed in from the keyboard during construction of the following entities:

 [CAD > Build > Block](#)

 [CAD > Build > FF Loop](#)

 [CAD > Build > DD Loop](#)

 [CAD > Build > Grid Plane](#)

 [CAD > Build > Grid Line](#)

 [CAD > Build > Construction Lines](#)

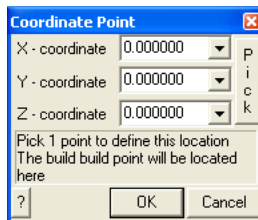

X, Y and Z – coordinate specify the coordinates of the point.

Pick - activates the cursor cross-hairs allowing interactive selection of the point from the model.

To assist in visually selecting points from the model, all snap functions are available.

 [CAD > Snap](#)

Once selected, the coordinates of the point are displayed in the dialogue box.

#### 4.5.1.9 Extrude/Offset Remaining

Extrudes a partially constructed entity to assist in generating the remaining points during construction of the following entities:

 [CAD > Build > Block](#)

 [CAD > Build > FF Loop](#)

 [CAD > Build > DD Loop](#)

 [CAD > Build > Grid Plane](#)

 [CAD > Build > Grid Line](#)

 [CAD > Build > Construction Lines](#)

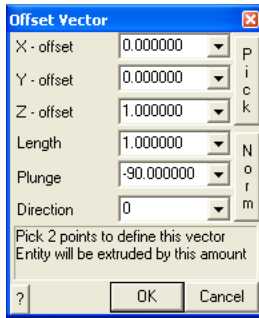

**X, Y and Z – offset** specify the components of the offset vector. All selected entities will be moved by this amount.

**Pick** - activates the cursor cross-hairs allowing interactive selection of the offset vector from the model. This requires that you select two points to define this vector.

**Length, Plunge and Direction** - specify the components of the offset vector. All selected entities will be moved by this amount.

**Norm** - activates the cursor allowing interactive selection of a surface to make the offset vector normal to. This requires that you select two points to define this vector. Once selected, the components of the offset vector are displayed in the dialogue box.

To assist in visually selecting points from the model, all snap functions are available.

 [CAD > Snap](#)

Once selected, the components of the offset vector are displayed in the dialogue box.

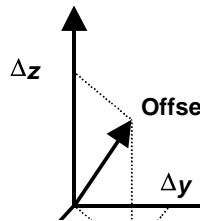

For example if you have constructed the base of a 3D block (points 1, 2, 3 and 4) and you wish to generate the remaining points (5, 6, 7 and 8) at one metre elevation above the base, you would simply enter the offset vector as (0,0,1).

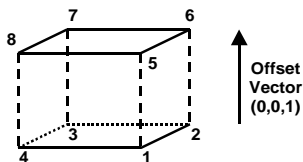

Note that it is possible to create zero volume blocks for example by specifying a zero length offset vector. This allows users to construct individual FF surfaces if desired. While this is permissible it is not recommended as this can lead to unclosed volumes.

#### 4.5.1.10 Undo Point

During block construction, points are selected in sequence. This allows points to be unselected during construction of the following entities:

 [CAD > Build > Block](#)

 [CAD > Build > FF Loop](#)

 [CAD > Build > DD Loop](#)

 [CAD > Build > Grid Plane](#)

 [CAD > Build > Grid Line](#)

 [CAD > Build > Construction Lines](#)

Any unselected points can be reselected using

 [CAD > Build > Redo Point](#)

Once you have completed block construction, you can undo this and remove this block from the model database by selecting (10 levels of undo/redo are supported)

 [CAD > Build > Undo Build](#)

You can then redo the block construction. This allows you to repeat any trial meshing operation.

 [CAD > Build > Undo Redo](#)

#### 4.5.1.11 Redo Point

During block construction, points are selected in sequence. This allows any points that have been unselected to be reselected during construction of the following entities:

 [CAD > Build > Block](#)

 [CAD > Build > FF Loop](#)

 [CAD > Build > DD Loop](#)

 [CAD > Build > Grid Plane](#)

 [CAD > Build > Grid Line](#)

 [CAD > Build > Construction Lines](#)

Points can be unselected using

 [CAD > Build > Undo Point](#)

Once you have completed block construction, you can undo this and remove this block from the model database by selecting (10 levels of undo/redo are supported)

 [CAD > Build > Undo Build](#)

You can then redo the block construction. This allows you to repeat any trial meshing operation.

 [CAD > Build > Undo Redo](#)

#### 4.5.1.12 Undo Build

During block construction, points are selected in sequence. This allows points to be unselected during construction of the following entities:

 [CAD > Build > Block](#)

 [CAD > Build > FF Loop](#)

 [CAD > Build > DD Loop](#)

 [CAD > Build > Grid Plane](#)

 [CAD > Build > Grid Line](#)

 [CAD > Build > Construction Lines](#)

Any unselected points can be reselected using

 [CAD > Build > Redo Point](#)

Once you have completed block construction, you can undo this and remove this block from the model database by selecting (10 levels of undo/redo are supported)

 [CAD > Build > Undo Build](#)

You can then redo the block construction. This allows you to repeat any trial meshing operation.

 [CAD > Build > Undo Redo](#)

#### 4.5.1.13 Redo Build

During block construction, points are selected in sequence. This allows any points that have been unselected to be reselected during construction of the following entities:

 [CAD > Build > Block](#)

 [CAD > Build > FF Loop](#)

 [CAD > Build > DD Loop](#)

 [CAD > Build > Grid Plane](#)

 [CAD > Build > Grid Line](#)

 [CAD > Build > Construction Lines](#)

Points can be unselected using

 [CAD > Build > Undo Point](#)

Once you have completed block construction, you can undo this and remove this block from the model database by selecting (10 levels of undo/redo are supported)

 [CAD > Build > Undo Build](#)

You can then redo the block construction. This allows you to repeat any trial meshing operation.

 [CAD > Build > Undo Redo](#)

## 4.5.2 Snap

### 4.5.2.1 None

Disable snapping. No pick-box is displayed at the intersection of the cursor cross-hairs.

Points will be selected at the location indicated by the cross-hairs. This mode is useful for freehand sketching or digitizing. When digitizing, all three coordinate values are scaled off of the drawing. However when freehand sketching, only two of the coordinates can be located and the third must be supplied from the snap base

 [CAD > Snap > Cursor/Grid Base](#)

This is the recommended setting while digitizing.

### 4.5.2.2 Nearest Edge

Snap to the nearest edge.

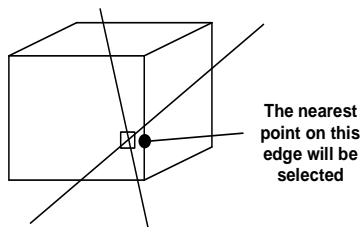

If the pick-box is located over the corner of an entity, that corner will be selected.

Otherwise the nearest point on the nearest edge will be selected.

The pick-box must be located over an entity or construction line.

### 4.5.2.3 Nearest Corner

Snap to the nearest corner.

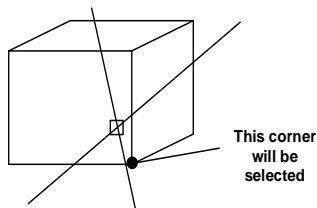

The corner nearest the pick-box will be selected.

The pick-box must be located over an entity or construction line.

#### 4.5.2.4 Nearest Surface

Snap onto the surface.

If the pick-box is located over the corner of an entity, that corner will be selected.

If the pick-box is located over an edge, the nearest point on that edge will be selected.

Otherwise the nearest point on the surface will be selected.

The pick-box must be located over an entity or construction line.

#### 4.5.2.5 Midpoint of Line

Snap to the midpoint of the selected edge.

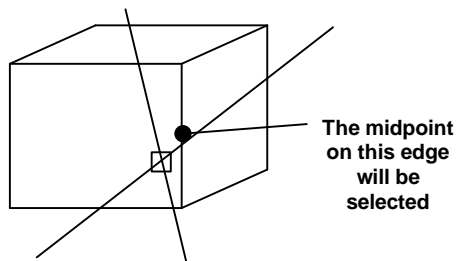

If the pick-box is located over the corner of an entity, that corner will be selected.

Otherwise the midpoint on the nearest edge will be selected.

The pick-box must be located over an entity or construction line.

#### 4.5.2.6 Tangent Snap

Force cursor tangent to the selected edge.

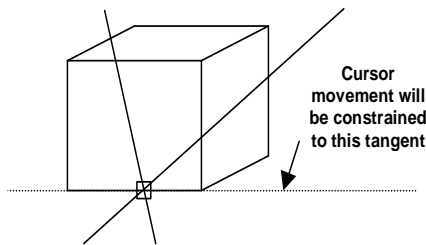





The edge nearest the pickbox will be selected. The pick-box must be located over an entity or construction line.

Once selected, all cursor movement will be constrained to the tangent defined by the selected edge. Points can now be selected anywhere along this tangent.

Once a point is selected, tangent snap is automatically cancelled. Tangent snap can be cancelled at any time by pressing the escape key (Esc) or right click the mouse.

To select points at even spacing along the tangent line, tangent snap can be used in conjunction with any of:

-  [CAD > Snap > Grid Snap](#) Snap to a rectangular grid.
-  [CAD > Snap > X-Grid Snap](#) Snap to the selected edge at an even X grid spacing.
-  [CAD > Snap > Y-Grid Snap](#) Snap to the selected edge at an even Y grid spacing.
-  [CAD > Snap > Z-Grid Snap](#) Snap to the selected edge at an even Z grid spacing.

#### 4.5.2.7 Intersection Snap

Snap to the intersection of the selected edge and a tangent.

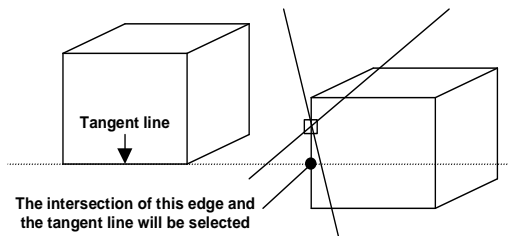

Since this function operates in full 3D, the tangent may pass above or below the selected edge and not actually intersect. In this case the closest point to the tangent line on the selected edge will be picked.

This convention must be emphasized. The intersection point will not be selected on the tangent line: it will be selected on the intersection line.

Using this feature is a two step process. When you click on the Intersect Snap button  you will be prompted as follows:

1. First select a tangent line.
2. Then select the edge you want to intersect the tangent with. The point will be selected on this line.

The edge nearest the pickbox will be selected.

The pick-box must be located over an entity or construction line.

This function can be used to locate points at the intersection of the tangent and the projection of the selected edge.

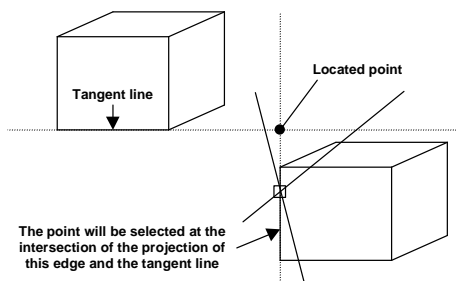

Once a point is selected, intersection snap is automatically cancelled. Intersection snap can be cancelled at any time by pressing the escape key (Esc) or right click the mouse.

For an example on the use of intersection snap in model building refer to

[Tabular Mining](#)

#### 4.5.2.8 Trace Virtual Line Snap

Generate points along a virtual line segment. This snap mode is generally used in conjunction with [CAD > Snap > Trace Cline](#) as a quick method for building DDLoops ([CAD > Build > DDLoop](#)) and FFLoops ([CAD > Build > FFLoop](#)).

To use this snap mode you simply define the virtual line segment by picking the start and end points, and the function will automatically generate points along this line. For example if you select points 4 and 10, the points along the dashed line will be automatically generated.

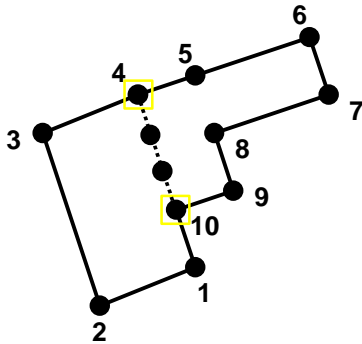

Notes:

The location of all points along construction lines can be viewed by setting the [View > Render > Cline dot radius](#) parameter.

#### 4.5.2.9 Trace Cline Snap

Snap to selected corners along a construction line segment. This snap mode can be used as a quick method for building DDLoops ([CAD > Build > DDLoop](#)) and FFLoops ([CAD > Build > FFLoop](#)).

To use this snap mode you simply pick the start and end points along the desired construction line segment and all point between these will be automatically selected. For example if you select points 4 and 9, points 5, 6, 7 and 8 will automatically be selected. Note that if you select the same point twice, the entire loop will be selected.

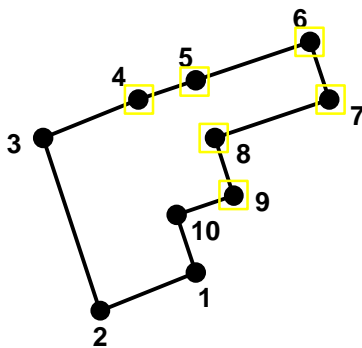



Notes:

The location of all points along construction lines can be viewed by setting the [View > Render > Cline dot radius](#) parameter.

Before using this trace snap mode, construction lines should be cleaned up using the [CAD > Pack and Renumber Clines](#) function.

The [CAD > Edit > Smooth Construction Lines](#) function can also be used to aid in cleaning up construction lines.

#### 4.5.2.10 Trace Cloop Snap

Snap to all corners along a construction line segment. This snap mode can be used as a quick method for building DDLoops ([CAD > Build > DDLoop](#)) and FFLoops ([CAD > Build > FFLoop](#)).

To use this snap mode you simply pick a single points on the desired construction line segment and all points on this line will be automatically selected. For example if you select point 4, points 5, 6, 7, 8, 1, 2 and 3 will automatically be selected.

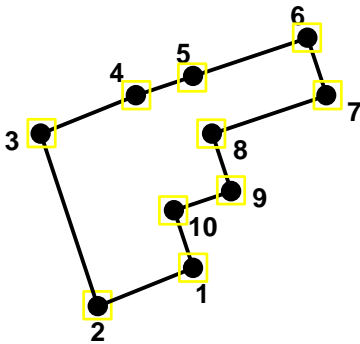

Notes:

The location of all points along construction lines can be viewed by setting the [View > Render > Cline dot radius](#) parameter.

Before using this trace snap mode, construction lines should be cleaned up using the [CAD > Pack and Renumber Clines](#) function.

The [CAD > Edit > Smooth Construction Lines](#) function can also be used to aid in cleaning up construction lines.

#### 4.5.2.11 Rectangular Grid Snap

Snap to a rectangular grid. No pick-box is displayed at the intersection of the cursor cross-hairs.

All cursor movement will be constrained to the grid points.

The grid can be oriented in either the X-Y, Y-Z or X-Z planes at any desired spacing and location. To set up these parameters use

[CAD > Snap > Cursor/Grid Setup](#) setup the cursor/grid spacing and orientation.

For an example on the use of grid snap mode in model building refer to

[Freehand Sketching - Room and Pillar.](#)

#### 4.5.2.12 Circular Grid Snap

Snap to a cylindrical grid. No pick-box is displayed at the intersection of the cursor cross-hairs.

All cursor movement will be constrained to the grid points.

The grid can be oriented in either the X-Y, Y-Z or X-Z planes at any desired spacing and location. To set up these parameters use

 [CAD > Snap > Cursor/Grid Setup](#) setup the cursor/grid spacing and orientation.

#### 4.5.2.13 X-Grid Snap

Snap to an x-grid spacing.

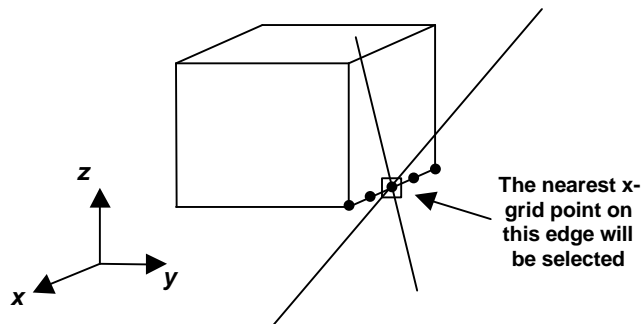

If the pick-box is located over the corner of an entity, that corner will be selected.

Otherwise the nearest point at the x-grid spacing on the nearest edge will be selected.

The pick-box must be located over an entity or construction line.

Since the x coordinate values are constrained to the prescribed X-grid spacing, the y and z coordinate values are calculated from the equation of the selected line.

The grid spacing and location are defined either by picking the X-Grid Snap button  a second time or use

 [CAD > Snap > Cursor/Grid Setup](#) setup the cursor/grid spacing and orientation.

X-grid snap can be used in conjunction with any of:

 [CAD > Snap > None](#) Disable snapping.

 [CAD > Snap > Edge](#) Snap to the nearest edge.

 [CAD > Snap > Tangent Snap](#) Force cursor tangent to the selected edge.

#### 4.5.2.14 Y-Grid Snap

Snap to a y-grid spacing.

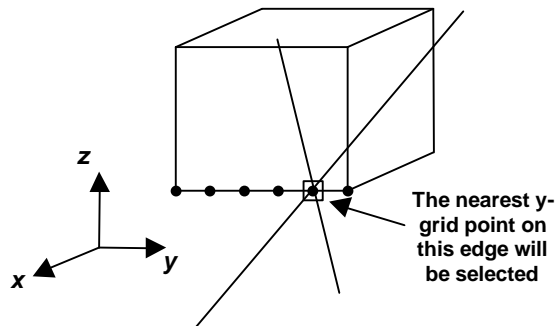

If the pick-box is located over the corner of an entity, that corner will be selected.

Otherwise the nearest point at the y-grid spacing on the nearest edge will be selected.

The pick-box must be located over an entity or construction line.

Since the y coordinate values are constrained to the prescribed y-grid spacing, the x and z coordinate values are calculated from the equation of the selected line.

The grid spacing and location are defined either by picking the Y-Grid Snap button  a second time or use

 [CAD > Snap > Cursor/Grid Setup](#) setup the cursor/grid spacing and orientation.

Y-grid snap can be used in conjunction with any of:

 [CAD > Snap > None](#) Disable snapping.

 [CAD > Snap > Edge](#) Snap to the nearest edge.

 [CAD > Snap > Tangent Snap](#) Force cursor tangent to the selected edge.

#### 4.5.2.15 Z-Grid Snap

Snap to a z-grid spacing.

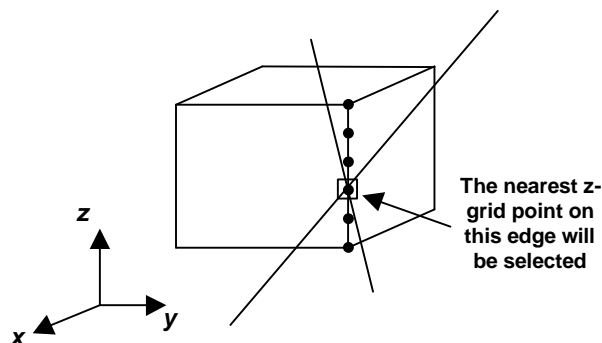

If the pick-box is located over the corner of an entity, that corner will be selected.

Otherwise the nearest point at the y-grid spacing on the nearest edge will be selected.

The pick-box must be located over an entity or construction line.

Since the z coordinate values are constrained to the prescribed Z-grid spacing, the x and y coordinate values are calculated from the equation of the selected line.

The grid spacing and location are defined either by picking the Z-Grid Snap button  a second time or use

 [CAD > Snap > Cursor/Grid Setup](#) setup the cursor/grid spacing and orientation.

Z-grid snap can be used in conjunction with any of:

 [CAD > Snap > None](#) Disable snapping.

 [CAD > Snap > Edge](#) Snap to the nearest edge.

 [CAD > Snap > Tangent Snap](#) Force cursor tangent to the selected edge.

#### 4.5.2.16 Cursor/Grid Setup

Setup the cursor/grid location, spacing and orientation.

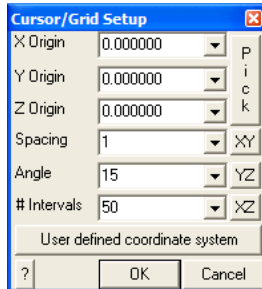

**X, Y and Z Origin** - specifies the coordinates of the centre of the grid.

**Pick** - activates the cursor cross-hairs allowing interactive selection of the cursor/grid base from the model.

**Spacing** - specifies the distance between grid points.

**Angle** - specifies the angle (in degrees) between the radii of the cylindrical grid.



**# Intervals** - specifies the number of grid points that will be displayed.

 [CAD > Snap > XY Cursor](#) - constrains the cursor cross-hairs and snap grid to the X-Y plane.

 [CAD > Snap > YZ Cursor](#) - constrains the cursor cross-hairs and snap grid to the Y-Z plane.

 [CAD > Snap > XZ Cursor](#) - constrains the cursor cross-hairs and snap grid to the X-Z plane.

 [CAD > Snap > User defined Cursor](#) - constrains the cursor cross-hairs and snap grid to the user defined plane.

The user defined coordinate system is only active with rectangular and circular grid snapping (  [CAD > Snap > Grid Snap](#) and  [CAD > Snap > Cylinder Snap](#)).

The user defined plane is specified by its dip ( $\phi$ ), dip direction ( $\vartheta$ ) and rake ( $\alpha$ ) such that:

- The local x-axis ( $x'$ ) is defined along the strike of the plane.
- The local y-axis ( $y'$ ) is defined as down dip.
- The local z-axis is perpendicular to the plane.
- Rake allows for rotation around the local z-axis.

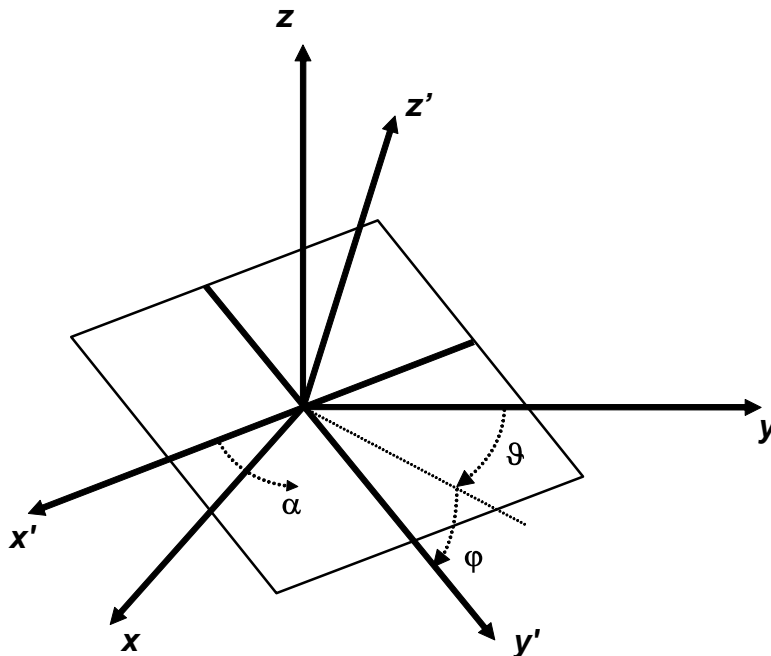
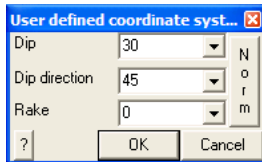

For an example on the use of grid snap mode in model building refer to

[Freehand Sketching - Room and Pillar.](#)

## 4.5.3 Properties

### 4.5.3.1 Control Parameters

Specification of analysis control parameters.

Parameter	Value
Job Title	Project Title
Maximum # of Time Steps (NLD)	10000
Maximum # of Iterations (NIT)	10000
Stress Tolerance (STOL)	0.100
Relaxation Parameter (RPAR)	1.200
Element Length (AL)	10
Grid Spacing (AG)	10
Grid Discretize (DOL)	1
Element Discretize (DON)	1
Matrix Lumping (DOC)	1
Element Lumping (DOE)	2
Grid Lumping (DOG)	2
Aspect ratio (DOR)	5

**Job Title** - specifies a descriptive project title.

**Maximum # of Time Steps (NLD)** - specifies the maximum number of steps that will be used during analysis. This parameter is only relevant if you are conducting a non-linear creep analysis

[Analysis > Options > Creep](#)

where this limits the actual number of time steps.

If this parameter is exceeded, the program stops and the user is prompted for instructions on how to proceed. This parameter can be modified during solution.

Unless the user has some special reason for limiting the number of time steps this parameter should be set to an arbitrarily large number.

**Maximum # of Iterations (NIT)** - specifies the maximum number of iterations that will be used during matrix solution.

If this parameter is exceeded, the program stops and the user is prompted for instructions on how to proceed. This parameter can be modified during solution.

Unless the user has some special reason for limiting the number of time steps this parameter should be set to an arbitrarily large number.

**Stress Tolerance (STOL)** - specifies the required accuracy of the matrix solution.

During matrix solution the accuracy is successively improved with each iteration. When the maximum stress error falls below this value the matrix can be considered to be solved.

The suggested value for the parameter is 0.1% of the far field stress state at the depth of interest. **STOL** should be specified in the same units as the far field stress state (e.g. MPa or psi).

**Relaxation Parameter (RPAR)** - specifies the maximum relaxation value that will be used during

matrix solution.

During matrix solution the program continuously modifies the relaxation parameter in an attempt to obtain convergence with as few as possible iterations. This parameter limits the maximum value that will be used.

The value of 1.2 is recommended for well-conditioned problems. For poorly conditioned problems a value of 0.8 should be used.

**Element Length (AL)** - specifies the minimum element length.

During the discretization process all model surfaces (surfaces of FF blocks and DD planes) are subdivided into boundary elements with side length

$$Lelem = Delem/DON$$

where *Delem* is determined by Map3D as the smallest distance between adjacent model surfaces. Since at some locations the distance *Delem* may be zero, the minimum element side length *AL* must be specified.

*AL* should be set equal to twice the smallest pillar or stope width. The same units used to specify the coordinates should be used (e.g. metres or feet).

Once discretization is complete, the distance *Delem* can be plotted using

 [Plot > Miscellaneous > Delem](#) distance to nearest element on surfaces.

Note that if desired, this behaviour can be overridden on an element by element basis by specifying the maximum width for each element

 [CAD > Edit > Entity Properties > Maximum Width](#)

This allows users to force fine uniform discretization on surfaces in areas where there are no grid planes.

**Grid Spacing (AG)** - specifies the minimum grid spacing.

During the discretization process all field point grids and model surfaces are subdivided into elements with side length

$$Lgrid = Dgrid/DOL$$

where *Dgrid* is determined by Map3D as the smallest distance between model surfaces and grid planes. Since at some locations the distance *Dgrid* may be zero, the minimum grid spacing *AG* must be specified. This same process is used to discretize model surfaces (surfaces of FF blocks and DD planes) that are near field point grids.

*AG* should be set equal to the smallest dimension of interest. For example if the user needs to see the stress distribution across a 2m wide pillar, a value for *AG* of 0.5 would give sufficient number of field points for accurate contouring. The same units used to specify the coordinates should be used (e.g. metres or feet).

Once discretization is complete, the distance *Dgrid* can be plotted on model surfaces using

 [Plot > Surface Components > Dgrid](#) distance to nearest grid

or on grids using

 [Plot > Miscellaneous > Delem](#) distance to nearest element on grids.

Note that if desired, this behaviour can be overridden on a grid by grid basis by specifying the

maximum spacing for each grid

 [CAD > Edit > Entity Properties > Maximum Width](#)

This allows users to force fine uniform discretization on grids.

**Grid Discretize (*DOL*)** - specifies the desired distance to element length ratio used to determine the grid spacing from

$$L_{grid} = D_{grid}/DOL$$

where *Dgrid* is determined by Map3D as the smallest distance between model surfaces and grid planes.

A value for *DOL* of 1.0 is generally adequate and can be expected to provide solutions with 10-20% error. If higher accuracy is required a value for *DOL* of 2.0 should give 5-10% error. Use a value of 4.0 for less than 5% error. Although higher values of *DOL* results in generation of more boundary elements and hence longer run times, this is necessary to obtain increased accuracy.

Once discretization is complete, the ratio of *Dgrid/Lelem* can be plotted on model surfaces using

 [Plot > Miscellaneous > Dgrid/Lelem \*DOL\*](#) ratio on surfaces

or the ratio of *Dgrid/Lgrid* on grids using

 [Plot > Miscellaneous > Dgrid/Lgrid \*DOL\*](#) ratio on grids.

**Element Discretize (*DOM*)** - specifies the desired distance to element length ratio used to determine the element side length

$$Lelem = Delem/DON$$

where *Delem* represents the distance to the nearest model surface.

A value for *DON* of 0.5 is generally adequate for all problems except those with very narrow excavations or pillars. In this latter case a value for *DON* of 1.0 is recommended. Although higher values of *DON* results in generation of more boundary elements and hence longer run times, this is necessary to obtain a well conditioned solvable problem for very narrow excavations or pillars.

Once discretization is complete, the ratio of *Delem/Lelem* can be plotted using

 [Plot > Miscellaneous > Delem/Lelem \*DON\*](#) ratio on surfaces.

**Matrix Lumping (*DOC*)** - specifies the desired distance to element length ratio. During matrix assembly, all elements that fit within the dimension

$$Delem/DOC$$

will be lumped together. *Delem* represents the distance to the nearest model surface.

Just as for *DOL*, a value for *DOC* of 1.0 is generally adequate and can be expected to provide solutions with 10-20% error. If higher accuracy is required a value for *DOC* of 2.0 should give 5-10% error. Use a value of 4.0 for less than 5% error. Although higher values of *DOC* result in larger coefficient matrices and hence longer run times, this is necessary to obtain increased accuracy.

Once discretization is complete, the distance *Delem* can be plotted using

 [Plot > Miscellaneous > Delem](#) distance to nearest element on surfaces.

**Element Lumping (*DOE*)** - specifies the desired distance to element length ratio. During grid assembly, all elements that fit within the dimension



### *Dgrid/DOE*

will be lumped together. *Dgrid* represents the distance to the nearest field point grid surface.

A value for *DOE* of 2.0 is generally adequate and can be expected to provide solutions with 10-20% error. If higher accuracy is required a value for *DOE* of 4.0 should give 5-10% error. Use a value of 8.0 for less than 5% error. Although higher values of *DOE* result in longer run times, this is necessary to obtain increased accuracy.

Once discretization is complete, the distance *Dgrid* can be plotted on grids using

 [Plot > Miscellaneous > Delem](#) distance to nearest element on grids.

**Grid Lumping (DOG)** - specifies the desired distance to element length ratio. During grid assembly, all grid points that fit within the dimension

### *Dgrid/DOG*

will be lumped together. *Dgrid* represents the distance to the nearest field point grid surface.

A value for *DOG* of 2.0 is generally adequate and can be expected to provide solutions with 10-20% error. If higher accuracy is required a value for *DOG* of 4.0 should give 5-10% error. Use a value of 8.0 for less than 5% error. Although higher values of *DOG* result in longer run times, this is necessary to obtain increased accuracy.

Once discretization is complete, the distance *Dgrid* can be plotted on grids using

 [Plot > Miscellaneous > Delem](#) distance to nearest element on grids.

**Aspect Ratio (DOR)** - specifies the desired element aspect ratio. A value for *DOR* of 5.0 is recommended for all problems except where the user wants narrow elements subdivided into more uniform shapes.

**Comments** - allows you to specify comments to be saved with the run.

### Summary:

*STOL* should be set equal to 0.1% of the far field stress state at the depth of interest. Use the same units as the far field stress state (e.g. MPa or psi).

*AL* should be set equal to twice the smallest pillar or stope width. Use the same units used to specify the coordinates (e.g. metres or feet).

*AG* should be set equal to the smallest dimension of interest. Use the same units used to specify the coordinates (e.g. metres or feet).

*DON*=0.5, *DOL*=*DOC*=1, *DOE*=*DOG*=2 for 10-20% error.

*DON*=0.5, *DOL*=*DOC*=2, *DOE*=*DOG*=4 for 5-10% error.

*DON*=1, *DOL*=*DOC*=4, *DOE*=*DOG*=8 for < 5% error.

Elements are discretized to a side length that is the smaller of *Delem/DON* and *Dgrid/DOL*, such that it cannot be less than *AL* and cannot be larger than the maximum width.

Grid are discretized to a spacing is determined from *Dgrid/DOL* such that is cannot be less than *AG* and cannot be larger than the maximum spacing.

During matrix assembly, all elements that fit within the dimension *Delem/DOC* will be lumped together.

During grid assembly, all elements that fit within the dimension *Dgrid/DOE* will be lumped together.

During grid assembly, all grid points that fit within the dimension *Dgrid/DOG* will be lumped together.

**Notes:**

For a more detailed discussion on discretization and lumping refer to

[Discretization and Lumping](#).

#### 4.5.3.2 Mining Step Titles

Specification of a specifies a descriptive title for each mining step.

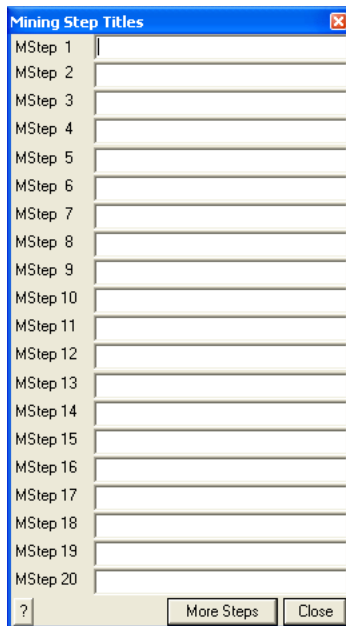

#### 4.5.3.3 Material Properties

Specification of material properties.

Several different dialogue boxes will appear depending on the material type selected: Mohr-Coulomb, Hoek-Brown, Drucker-Prager, Backfill Hyperbolic and None.

[Mohr-Coulomb in 3D FF blocks](#) can be used as a flow rule for non-linear material behaviour in Map3D Non-Linear and Map3D Visco-Plastic. Can also be used as failure criterion in 3D FF blocks or in the host material in Map3D Fault-Slip.

[Hoek-Brown in 3D FF blocks](#) can be used as failure criterion in 3D FF blocks or in the host material in Map3D Fault-Slip.

[Drucker-Prager in 3D FF blocks](#) can be used as failure criterion in 3D FF blocks or in the host material in Map3D Fault-Slip.

[Fault-Gouge in DD planes](#) can be used as a flow rule in DD planes in Map3D Fault-Slip, Map3D Non-Linear or Map3D Visco-Plastic.

[Hyperbolic-Backfill in DD planes](#) can be used as a flow rule in DD planes in Map3D Fault-Slip, Map3D Non-Linear or Map3D Visco-Plastic.

[Quadratic-Backfill in DD planes](#) can be used as a flow rule in DD planes in Map3D Fault-Slip, Map3D Non-Linear or Map3D Visco-Plastic.

[Equilbrated-Gouge in DD planes](#) can be used as a flow rule in DD planes in Map3D Fault-Slip, Map3D Non-Linear or Map3D Visco-Plastic.

[Yielding-Pillar in DD planes](#) can be used as a flow rule in DD planes in Map3D Fault-Slip, Map3D Non-Linear or Map3D Visco-Plastic.

In elastic analyses the failure criterion is used only for strength factor calculations and contour plotting and does not affect the analysis results.

In non-linear analyses (3D FF blocks in Map3D Non-Linear, 3D FF blocks in Map3D Visco-Plastic, and DD planes in Map3D Fault-Slip) the failure criterion is used as a flow rule to control yielding and non-linear deformations.

#### 4.5.3.4 Map3Di Setup

Sets up the Map3Di analysis.

Map3Di allows one to superimpose external field loading effects into the Map3D model. For details on this feature refer to [Map3Di](#).

When you check a Map3Di loading file for use you will be prompted to search for a file name, location. If the search is successful, the file will be checked.

The Map3Di loading file is specified in polyline file format. Refer to [Contour Plane Options](#) for details on generating a Map3Di loading file.

Comment lines must start with an asterisk "\*" in column 1.

2D planes are stored as a series of triangle or quadrilateral polylines as follows:

```
x1 y1 z1 3 values1
x2 y2 z2 2 values2
x3 y3 z3 2 values3
x4 y4 z4 2 values4
...
```

3D blocks are stored as a series of tetrahedral or hexahedral polylines as follows:

```
x1 y1 z1 3 values1
x2 y2 z2 2 values2
x3 y3 z3 2 values3
x4 y4 z4 2 values4
x5 y5 z5 1 values5
x6 y6 z6 1 values6
x7 y7 z7 1 values7
x8 y8 z8 1 values8
...
```

where  $x_i$   $y_i$   $z_i$  represent the coordinates of each point.

3 indicates that this point is the beginning of a new polyline.

2 indicates that this point forms part of the base of the block.

1 indicates that this point forms part of the top of the block. This item is only used for definition of 3D block shapes.

Additional polylines are specified by repeating the sequence (i.e. starting a new polyline with the number 3).

Any of the points can be repeated or skipped to specify triangular shaped sides or tetrahedrons.

**values<sub>i</sub>** specifies the magnitude of the field loading at the centre, or at each corner. If only **values<sub>1</sub>** is specified (i.e. **values<sub>2</sub>** ... are left blank) that value is applied uniformly across the entity.

If **values** are specified for all corners, the field loading is applied according to a higher order polynomial distribution.

For 2D surface triangles a linear distribution is used

$$a + b x + c y$$

For 2D quadrilaterals, the following distribution is used

$$a + b x + c y + d x y$$

For 3D block shapes, as many terms as possible of the distribution are used

$$a + b x + c y + d z + e x y + f y z + g z x + h x y z$$

The actual field loading effects can be specified in several ways.

### 2D Planes

2D planes define a Displacement Discontinuity with specified normal displacement (closure)  $\delta_n$ , and shear displacement (ride)  $\delta_s$ , such that **values<sub>i</sub>** can be specified either as

$$\delta_n \delta_s \text{ or } \delta_n \delta_{s1} \delta_{s2}$$

If only  $\delta_n \delta_s$  are specified, the shear displacement (ride) is applied parallel to the maximum in-plane shear stress for the 2D plane.

If all of  $\delta_n \delta_{s1} \delta_{s2}$  are specified, the shear displacement (ride) component  $\delta_{s1}$  is applied parallel to the first side (i.e. the side defined by  $x_1 y_1 z_1 - x_2 y_2 z_2$ ).  $\delta_{s2}$  is applied perpendicular to  $\delta_{s1}$  in the direction of the second side (i.e. the side defined by  $x_2 y_2 z_2 - x_3 y_3 z_3$ ).

Shear displacement (ride) and normal displacement (closure) are specified in displacement units (i.e. the same units as the geometry is specified in (metres).

The shear displacement (ride) and normal displacement (closure) may be determined from in situ or laboratory measurements of shear, closure and/or crack opening, or from another numerical modelling program such as a reservoir or hydraulic fracture simulator. These can also be estimated from seismic monitoring data.

### 3D Blocks

3D blocks define a zone with specified strain  $\epsilon$ , either as

$$\epsilon_1 \epsilon_2 \epsilon_3 \text{ Or } \epsilon_{xx} \epsilon_{yy} \epsilon_{zz} \epsilon_{xy} \epsilon_{yz} \epsilon_{zx}$$

If only  $\epsilon_1 \epsilon_2 \epsilon_3$  are specified, these principal strains are applied parallel to the principal stresses. The strains are used to determine the initial stress  $\sigma^0$  using

$$\sigma_1^\circ = [ (1-\nu) \varepsilon_1 + \nu ( \varepsilon_2 + \varepsilon_3 ) ] E / [ (1+\nu) (1-2\nu) ]$$

$$\sigma_2^\circ = [ (1-\nu) \varepsilon_2 + \nu ( \varepsilon_3 + \varepsilon_1 ) ] E / [ (1+\nu) (1-2\nu) ]$$

$$\sigma_3^\circ = [ (1-\nu) \varepsilon_3 + \nu ( \varepsilon_1 + \varepsilon_2 ) ] E / [ (1+\nu) (1-2\nu) ]$$

If all of  $\varepsilon_{xx}$   $\varepsilon_{yy}$   $\varepsilon_{zz}$   $\varepsilon_{xy}$   $\varepsilon_{yz}$   $\varepsilon_{zx}$  are specified, these strains are applied as Cartesian components. The strains are used to determine the initial stress  $\sigma^\circ$  using

$$\sigma_{xx}^\circ = [ (1-\nu) \varepsilon_{xx} + \nu ( \varepsilon_{yy} + \varepsilon_{zz} ) ] E / [ (1+\nu) (1-2\nu) ]$$

$$\sigma_{yy}^\circ = [ (1-\nu) \varepsilon_{yy} + \nu ( \varepsilon_{zz} + \varepsilon_{xx} ) ] E / [ (1+\nu) (1-2\nu) ]$$

$$\sigma_{zz}^\circ = [ (1-\nu) \varepsilon_{zz} + \nu ( \varepsilon_{xx} + \varepsilon_{yy} ) ] E / [ (1+\nu) (1-2\nu) ]$$

$$\tau_{xy}^\circ = \varepsilon_{xy} E / (1+\nu)$$

$$\tau_{yz}^\circ = \varepsilon_{yz} E / (1+\nu)$$

$$\tau_{zx}^\circ = \varepsilon_{zx} E / (1+\nu)$$

Strains are specified in dimensionless strain units (i.e. 0.001 would specify 1000 micro strain).

$E$  and  $\nu$  represent respectively Young's modulus and Poisson's ratio. Map3D automatically determines which material the corner of the 3D block is located within and uses the corresponding material properties.

The strains may be determined from in situ or laboratory measurements of temperature or fluid pressure, or from another numerical modelling program such as a thermal analysis code. These can also be estimated from seismic monitoring data.

The strains that should be applied can be determined from the temperature through an expansion coefficient  $A$ , where the temperature change or fluid pressure change (from the background value) induces the initial stresses

$$\sigma_1^\circ = \sigma_2^\circ = \sigma_3^\circ = A \Delta T$$

For fluid flow problems the expansion coefficient  $A$ , should be set to unity (positive one) for saturated media. For thermal problems the expansion coefficient should be specified as a negative quantity given by

$$A = \alpha E / (1-2\nu)$$

where  $\alpha$  represents the coefficient of thermal expansion (i.e. the linear expansivity).

### Notes

This function must be set up before conducting the Map3D BEM analysis

[Analysis > BEM Analysis.](#)

 [CAD > Properties > Map3Di Setup > View](#) enables viewing of the Map3Di data.

### 4.5.3.5 Model Information

Displays the current tally for the following model parameters:

- number of surfaces used to define the geometry,
- number of coordinates used to define the surfaces,

- number of mining steps.

The following parameters are only displayed after the discretization analysis ([Analysis > Discretization](#)) is complete:

- number of boundary elements,
- number of boundary nodes (only used for higher order elements ([Analysis > Options > Linear](#))),
- number of field points on user defined grids.

## 4.5.4 Edit

### 4.5.4.1 Entity Properties









Edit block type, colour, mining sequence etc.

This routine can be initiated either by picking the  button or simple right-clicking on any entity. When you initiate this routine you will first be prompted to build a list of entities that you wish to edit



- If [Tools > Shift-key Selection](#) is checked, you must hold down the Shift-key to make multiple selections.
- By default, selected entities are added to the list, however if the Ctrl-key is held down, selected entities will be removed from the list.
- While holding down the Shift-key or Ctrl-key, you can drag open a crossing window.
- Use of this toolbar is detailed in [Build A List of Entities for Editing](#)
- Pressing the space-bar automatically activates the last edit function that was used.
- Holding the Alt-key when you right-click automatically repeats the last edit function that was used.

Once you have selected the desired entities, you can either pick any of the edit buttons:

-  [CAD > Edit > Entity Properties](#) Edit block type, colour, mining sequence,
-  [CAD > Edit > Erase Entities](#) Erase selected entities,
-  [CAD > Edit > Move Entities](#) Move selected entities,
-  [CAD > Edit > Copy Entities](#) Copy selected entities,
-  [CAD > Edit > Scale Entities](#) Scale selected entities,
-  [CAD > Edit > Rotate Azimuth](#) Rotate the azimuth of selected entities,
-  [CAD > Edit > Rotate Dip](#) Rotate the dip of selected entities,
-  [CAD > Edit > Dump to File](#) Dump selected entities to a file,
-  [CAD > Edit > Group](#) Group selected entities into a single block,

- double click on any vertex to execute the highlighted function,
- right click for a list of options.

If any of the fields in the dialogue box read "Variable" it is because some of the blocks you have selected have different properties for that field. If you wish to leave these properties as they are (i.e. different for each block), leave the field as "Variable". If you wish to change the value of that field for all selected blocks, enter the desired value.

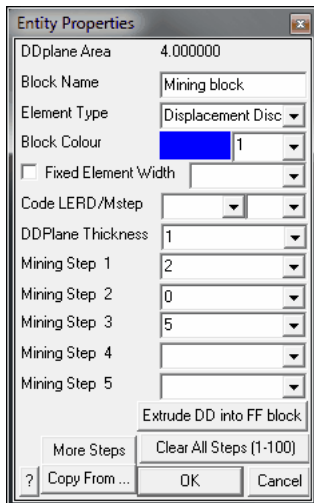

**Block Volume** - If you have selected all FF blocks, the total combined volume of the blocks will be displayed. If you have selected all DD blocks, the total combined volume of the blocks will be displayed.

**DDPlane Area** - If you have selected all DD blocks, displays the combined area of all of the DDPlanes included in the DDLoop.

**Block Name** - specifies a descriptive name for the block.

**Element Type** - specifies the type of boundary element that will be used for the block.

- **Displacement Discontinuity** - DD type elements should be used for tabular mining excavations, fractures and fault planes.
- **Fictitious Force** - FF type elements should be used for three-dimensional features such as excavations, alternate material zones, back-filled stopes etc.
- Inactive elements can be used to display features that are to be included for visualization purposes only and not to be used for the actual stress analysis.
- Note that DD type elements can be changed into [GPlanes](#).

**Block Colour** - specifies the colour number that will be used to display the block.

- Specifies the colour number that will be assigned to each button. A total of 10 colours are available for display. These are numbered respectively  
1 through 10,  
11 through 20,  
21 through 30, etc.,
- such that the same colour is displayed for numbers  
1, 11, 21...,  
2, 22, 32...,  
3, 23, 33..., etc.

**Fixed Element Width** - specifies the user defined element width.

- This parameter can be used to force uniform discretization on selected entities. Extreme caution should be used in specifying this value since a small value can easily lead to enormous problem size.
- In general this option should not be used (unchecked) and discretization should be left to the [AL](#) and [AG](#) parameters. These latter parameters will concentrate elements only where analysis results are requested thus optimizing the use of elements and minimizing problem size. For

further discussion refer to

[CAD > Properties Control Parameters](#)

- This parameter can also be used to avoid making surfaces with sides larger than this during the intersection analysis. Any surfaces whose side length exceeds this dimension will not be collapsed

[Analysis > Options > Collapse](#)

- During the discretization process, any surface whose side length exceeds this dimension will be subdivided to prevent surfaces having sides larger than this.
- For an example of the use of this parameter refer to [Tabular Mining Example](#)

**Matl\_Code LERD/MStep** - specifies the material code that will be substituted into the block for the LERD/LSS calculation.

The first box is for the material code.

The second box is to specify the mining step number when the calculation is to be done. If this box is left blank then the LERD calculation will be done for all steps.

[Analysis > Options > LERD/LSS.](#)

**DDPlane Thickness** - specifies the thickness of the material inserted into the DD element (i.e. fault gouge, seam width, mining width or pillar height).

- Normal displacement (closure) of the feature when in-filled will be limited to this thickness. Also, the normal displacement (closure) and shear displacement (ride) are divided by the thickness to determine the strain occurring in the in-filling material

[Mohr-Coulomb in DD planes](#)

[Fault-Gouge in DD planes](#)

[Backfill-Hyperbolic in DD planes](#)

- This parameter should be specified in the same units used to specify the coordinate positions (e.g. metres or feet).

**Mining Step n** - specifies the material code that will be used for this block in mining step n.

- In the above example, the block is non-existent at step 1, has material #2 (Ore) inserted in it at step 2, it is excavated at step 3 (material code 0 means to excavate), and finally at step 4 material #5 (backfill) is inserted.
- When you use a positive material number, the material is placed into the block at the specified initial stress state, and is then allowed to deform according to the elastic/plastic properties you have set for that material number.
- When you use a negative material number, the material is placed into the block at the specified initial stress state, but the stress state is held at these values regardless of the deformations, thereby providing a stress boundary condition.

**Extrude DD into FF blocks** - allows you to extrude a DD plane into an FF block. You will be prompted for the extrusion vector

**More Steps** - allows specification of additional mining steps.

**Clear All Steps** - clears all mining steps (1-100).

**Copy From...** - allows you to select another block to copy the entity properties from.

**OK** - completes editing of blocks and modifies any properties that have been changed.



**Cancel** - aborts block editing.

Once you have completed any edit operation you have one chance to undo the modifications by selecting

 Undo

You can also restore the same selection set and modify the same set of entities again by selecting

 Redo

DD blocks can be extruded into 3D FF blocks simply by changing the element type from Displacement Discontinuity to Fictitious Force.

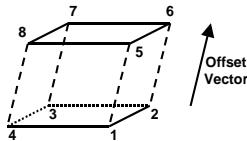

In this case corners 1 through 4 define the base of the block. The top and sides are automatically generated during the extrusion process. FF blocks can be collapsed into DD planes by changing the element type from Fictitious Force to Displacement Discontinuity. In this case the base of the block (the side defined by corners 1, 2, 3 and 4) will become the DD plane and the remainder of the block sides will be discarded.

Note that it is possible to create zero volume blocks for example by specifying a zero length offset vector. This allows users to construct individual FF surfaces if desired. While this is permissible it is not recommended as this can lead to unclosed volumes.

#### Notes

Different colour numbers should be used to represent logical groupings of blocks (e.g. for different levels, sections or logical mining units such as development, stoping etc.). These colours are user definable

[Tools > Custom Colours](#)

Any blocks with the same colour number will be automatically combined into single complex shapes by Map3D.

Since it is easy to toggle on and off the display of specific block colour numbers

 [View > Hide Block Colours](#)

This provides an efficient method to work with complex model data.

You can adjust the double click time using

[Tools > Double Click Time](#)

For discussion on model building aspects refer to:

[Model Building and Editing](#)

For tutorials on model building refer to:

[Model Building Tutorials](#)

#### 4.5.4.2 Erase Entities









Erase selected entities.

This routine can be initiated either by picking the  button or simple right-clicking on any entity. When you initiate this routine you will first be prompted to build a list of entities that you wish to edit



- If [Tools > Shift-key Selection](#) is checked, you must hold down the Shift-key to make multiple selections.
- By default, selected entities are added to the list, however if the Ctrl-key is held down, selected entities will be removed from the list.
- While holding down the Shift-key or Ctrl-key, you can drag open a crossing window.
- Use of this toolbar is detailed in [Build A List of Entities for Editing](#)
- Pressing the space-bar automatically activates the last edit function that was used.
- Holding the Alt-key when you right-click automatically repeats the last edit function that was used.

Once you have selected the desired entities, you can either pick any of the edit buttons:

-  [CAD > Edit > Entity Properties](#) Edit block type, colour, mining sequence,
-  [CAD > Edit > Erase Entities](#) Erase selected entities,
-  [CAD > Edit > Move Entities](#) Move selected entities,
-  [CAD > Edit > Copy Entities](#) Copy selected entities,
-  [CAD > Edit > Scale Entities](#) Scale selected entities,
-  [CAD > Edit > Rotate Azimuth](#) Rotate the azimuth of selected entities,
-  [CAD > Edit > Rotate Dip](#) Rotate the dip of selected entities,
-  [CAD > Edit > Dump to File](#) Dump selected entities to a file,
-  [CAD > Edit > Group](#) Group selected entities into a single block,

- double click on any vertex to execute the highlighted function,
- right click for a list of options.

Once you have completed any edit operation you have one chance to undo the modifications by selecting

 Undo

You can also restore the same selection set and modify the same set of entities again by selecting

 Redo

You can adjust the double click time using

[Tools > Double Click Time](#)

#### 4.5.4.3 Move Entities

Move selected entities.

This routine can be initiated either by picking the  button or simple right-clicking on any entity. When you initiate this routine you will first be prompted to build a list of entities that you wish to edit



- If [Tools > Shift-key Selection](#) is checked, you must hold down the Shift-key to make multiple selections.
- By default, selected entities are added to the list, however if the Ctrl-key is held down, selected entities will be removed from the list.
- While holding down the Shift-key or Ctrl-key, you can drag open a crossing window.
- Use of this toolbar is detailed in [Build A List of Entities for Editing](#)
- Pressing the space-bar automatically activates the last edit function that was used.
- Holding the Alt-key when you right-click automatically repeats the last edit function that was used.

Once you have selected the desired entities, you can either pick any of the edit buttons:

- [CAD > Edit > Entity Properties](#) Edit block type, colour, mining sequence,
- [CAD > Edit > Erase Entities](#) Erase selected entities,
- [CAD > Edit > Move Entities](#) Move selected entities,
- [CAD > Edit > Copy Entities](#) Copy selected entities,
- [CAD > Edit > Scale Entities](#) Scale selected entities,
- [CAD > Edit > Rotate Azimuth](#) Rotate the azimuth of selected entities,
- [CAD > Edit > Rotate Dip](#) Rotate the dip of selected entities,
- [CAD > Edit > Dump to File](#) Dump selected entities to a file,
- [CAD > Edit > Group](#) Group selected entities into a single block,

- double click on any vertex to execute the highlighted function,
- right click for a list of options.

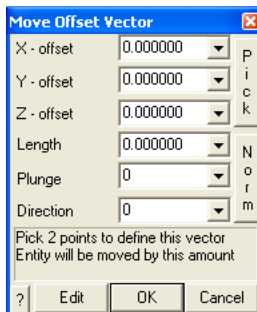

**X, Y and Z – offset** specify the components of the offset vector. All selected entities will be moved by this amount.

**Pick** - activates the cursor cross-hairs allowing interactive selection of the offset vector from the model. This requires that you select two points to define this vector.

**Length, Plunge and Direction** - specify the components of the offset vector. All selected entities will be moved by this amount.

**Norm** - activates the cursor allowing interactive selection of a surface to make the offset vector normal to.

- This requires that you select two points to define this vector.
- Once selected, the components of the offset vector are displayed in the dialogue box.

To assist in visually selecting points from the model, all snap functions are available.

[CAD > Snap](#)

Once selected, the components of the offset vector are displayed in the dialogue box.

**Edit** - completes editing and invoked editing of the entity properties for the selected blocks.

**OK** - completes editing of the offset vector and moves the selected blocks.

**Cancel** - aborts moving of entities.

Once you have completed any edit operation you have one chance to undo the modifications by selecting

 Undo

You can also restore the same selection set and modify the same set of entities again by selecting

 Redo

You can adjust the double click time using

[Tools > Double Click Time](#)

#### 4.5.4.4 Copy Entities









Copy selected entities.

This routine can be initiated either by picking the  button or simple right-clicking on any entity. When you initiate this routine you will first be prompted to build a list of entities that you wish to edit



- If [Tools > Shift-key Selection](#) is checked, you must hold down the Shift-key to make multiple selections.
- By default, selected entities are added to the list, however if the Ctrl-key is held down, selected entities will be removed from the list.
- While holding down the Shift-key or Ctrl-key, you can drag open a crossing window.
- Use of this toolbar is detailed in [Build A List of Entities for Editing](#)
- Pressing the space-bar automatically activates the last edit function that was used.
- Holding the Alt-key when you right-click automatically repeats the last edit function that was used.

Once you have selected the desired entities, you can either pick any of the edit buttons:

-  [CAD > Edit > Entity Properties](#) Edit block type, colour, mining sequence,
-  [CAD > Edit > Erase Entities](#) Erase selected entities,
-  [CAD > Edit > Move Entities](#) Move selected entities,
-  [CAD > Edit > Copy Entities](#) Copy selected entities,
-  [CAD > Edit > Scale Entities](#) Scale selected entities,
-  [CAD > Edit > Rotate Azimuth](#) Rotate the azimuth of selected entities,
-  [CAD > Edit > Rotate Dip](#) Rotate the dip of selected entities,
-  [CAD > Edit > Dump to File](#) Dump selected entities to a file,
-  [CAD > Edit > Group](#) Group selected entities into a single block,

- double click on any vertex to execute the highlighted function,
- right click for a list of options.

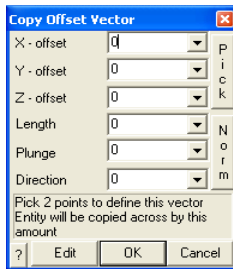

**X, Y and Z – offset** specify the components of the offset vector. All selected entities will be copied to the location specified by this offset.

**Pick** - activates the cursor cross-hairs allowing interactive selection of the offset vector from the model. This requires that you select two points to define this vector.

**Length, Plunge and Direction** - specify the components of the offset vector. All selected entities will be copied to the location specified by this offset.

**Norm** - activates the cursor allowing interactive selection of a surface to make the offset vector normal to.

- This requires that you select two points to define this vector.
- Once selected, the components of the offset vector are displayed in the dialogue box.

To assist in visually selecting points from the model, all snap functions are available.

 [CAD > Snap](#)

Once selected, the components of the offset vector are displayed in the dialogue box.

**Edit** - completes editing and invoked editing of the entity properties for the selected blocks.

**OK** - completes editing of the offset vector and moves the selected blocks.

**Cancel** - aborts moving of entities.

Once you have completed any edit operation you have one chance to undo the modifications by selecting

 Undo

You can also restore the same selection set and modify the same set of entities again by selecting

 Redo

You can adjust the double click time using

[Tools > Double Click Time](#)

#### 4.5.4.5 Scale Entities









Scale the selected entities.

This routine can be initiated either by picking the  button or simple right-clicking on any entity. When you initiate this routine you will first be prompted to build a list of entities that you wish to edit



- If [Tools > Shift-key Selection](#) is checked, you must hold down the Shift-key to make multiple selections.
- By default, selected entities are added to the list, however if the Ctrl-key is held down, selected entities will be removed from the list.
- While holding down the Shift-key or Ctrl-key, you can drag open a crossing window.
- Use of this toolbar is detailed in [Build A List of Entities for Editing](#)
- Pressing the space-bar automatically activates the last edit function that was used.
- Holding the Alt-key when you right-click automatically repeats the last edit function that was used.

Once you have selected the desired entities, you can either pick any of the edit buttons:

-  [CAD > Edit > Entity Properties](#) Edit block type, colour, mining sequence,
-  [CAD > Edit > Erase Entities](#) Erase selected entities,
-  [CAD > Edit > Move Entities](#) Move selected entities,
-  [CAD > Edit > Copy Entities](#) Copy selected entities,
-  [CAD > Edit > Scale Entities](#) Scale selected entities,
-  [CAD > Edit > Rotate Azimuth](#) Rotate the azimuth of selected entities,
-  [CAD > Edit > Rotate Dip](#) Rotate the dip of selected entities,
-  [CAD > Edit > Dump to File](#) Dump selected entities to a file,
-  [CAD > Edit > Group](#) Group selected entities into a single block,

- double click on any vertex to execute the highlighted function,
- right click for a list of options.

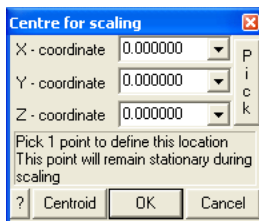

[X, Y and Z – coordinates](#) specify the coordinates of the centre for scaling. During scaling, this point will stay stationary. All other points will be moved to achieve the desired scaling.

[Pick](#) - activates the cursor cross-hairs allowing interactive selection of the centre or rotation from the model.

To assist in visually selecting points from the model, all snap functions are available.

 [CAD > Snap](#)

Once selected, the components of the centre for scaling are displayed in the dialogue box.

[Centroid](#) - calculates the centre of all selected entities.

[OK](#) - completes editing of the coordinates and prompts you for the scale factors.

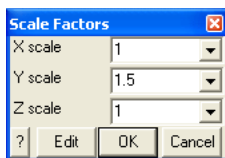

[X, Y and Z - scale](#) specifies the amount by which the entities are to be scaled. Below, the block is scaled 1.5 times in the y direction.

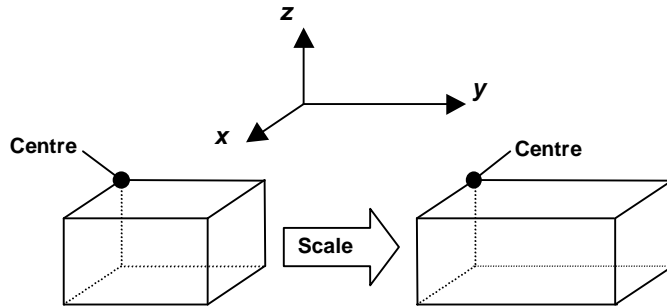

**Edit** - completes editing and invoked editing of the entity properties for the selected blocks.

**OK** - completes editing of the scale factors and scales the selected entities.

**Cancel** - aborts the scaling of entities.

Once you have completed any edit operation you have one chance to undo the modifications by selecting

 Undo

You can also restore the same selection set and modify the same set of entities again by selecting

 Redo

You can adjust the double click time using

[Tools > Double Click Time](#)

#### 4.5.4.6 Rotate Azimuth





Rotate the azimuth of selected entities.





This routine can be initiated either by picking the  button or simple right-clicking on any entity. When you initiate this routine you will first be prompted to build a list of entities that you wish to edit



- If [Tools > Shift-key Selection](#) is checked, you must hold down the Shift-key to make multiple selections.
- By default, selected entities are added to the list, however if the Ctrl-key is held down, selected entities will be removed from the list.
- While holding down the Shift-key or Ctrl-key, you can drag open a crossing window.
- Use of this toolbar is detailed in [Build A List of Entities for Editing](#)
- Pressing the space-bar automatically activates the last edit function that was used.
- Holding the Alt-key when you right-click automatically repeats the last edit function that was used.

Once you have selected the desired entities, you can either pick any of the edit buttons:

-  [CAD > Edit > Entity Properties](#) Edit block type, colour, mining sequence,
-  [CAD > Edit > Erase Entities](#) Erase selected entities,
-  [CAD > Edit > Move Entities](#) Move selected entities,
-  [CAD > Edit > Copy Entities](#) Copy selected entities,
-  [CAD > Edit > Scale Entities](#) Scale selected entities,

-  [CAD > Edit > Rotate Azimuth](#) Rotate the azimuth of selected entities,
-  [CAD > Edit > Rotate Dip](#) Rotate the dip of selected entities,
-  [CAD > Edit > Dump to File](#) Dump selected entities to a file,
-  [CAD > Edit > Group](#) Group selected entities into a single block,

- double click on any vertex to execute the highlighted function,
- right click for a list of options.

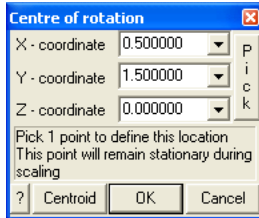

[X, Y and Z – coordinates](#) specify the coordinates of the centre of rotation.

[Pick](#) - activates the cursor cross-hairs allowing interactive selection of the centre or rotation from the model.

To assist in visually selecting points from the model, all snap functions are available.

 [CAD > Snap](#)

Once selected, the components of the centre for scaling are displayed in the dialogue box.

[Centroid](#) - calculates the centre of all selected entities.

[OK](#) - completes editing of the coordinates and prompts you for the scale factors.

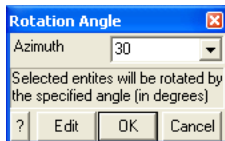

[Azimuth](#) - specifies the angle (in degrees) through which you want the selected entities to be rotated.

- The rotation takes place in the X-Y plane, thus all vertical lines remain vertical.

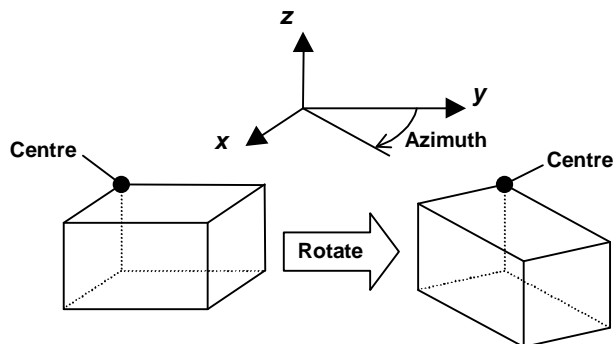

[Edit](#) - completes editing and invoked editing of the entity properties for the selected blocks.

[OK](#) - completes editing of the azimuth and rotates the selected entities.

[Cancel](#) - aborts the rotating of entities.

Once you have completed any edit operation you have one chance to undo the modifications by



selecting

 Undo

You can also restore the same selection set and modify the same set of entities again by selecting

 Redo

You can adjust the double click time using

[Tools > Double Click Time](#)

#### 4.5.4.7 Rotate Dip









Rotate the dip of selected entities.

This routine can be initiated either by picking the  button or simple right-clicking on any entity. When you initiate this routine you will first be prompted to build a list of entities that you wish to edit



- If [Tools > Shift-key Selection](#) is checked, you must hold down the Shift-key to make multiple selections.
- By default, selected entities are added to the list, however if the Ctrl-key is held down, selected entities will be removed from the list.
- While holding down the Shift-key or Ctrl-key, you can drag open a crossing window.
- Use of this toolbar is detailed in [Build A List of Entities for Editing](#)
- Pressing the space-bar automatically activates the last edit function that was used.
- Holding the Alt-key when you right-click automatically repeats the last edit function that was used.

Once you have selected the desired entities, you can either pick any of the edit buttons:

-  [CAD > Edit > Entity Properties](#) Edit block type, colour, mining sequence,
-  [CAD > Edit > Erase Entities](#) Erase selected entities,
-  [CAD > Edit > Move Entities](#) Move selected entities,
-  [CAD > Edit > Copy Entities](#) Copy selected entities,
-  [CAD > Edit > Scale Entities](#) Scale selected entities,
-  [CAD > Edit > Rotate Azimuth](#) Rotate the azimuth of selected entities,
-  [CAD > Edit > Rotate Dip](#) Rotate the dip of selected entities,
-  [CAD > Edit > Dump to File](#) Dump selected entities to a file,
-  [CAD > Edit > Group](#) Group selected entities into a single block,

- double click on any vertex to execute the highlighted function,
- right click for a list of options.

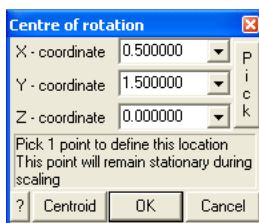

[X, Y and Z – coordinates](#) specify the coordinates of the centre of rotation.

**Pick** - activates the cursor cross-hairs allowing interactive selection of the centre or rotation from the model.

To assist in visually selecting points from the model, all snap functions are available.

 [CAD > Snap](#)

Once selected, the components of the centre for scaling are displayed in the dialogue box.

**Centroid** - calculates the centre of all selected entities.

**OK** - completes editing of the coordinates and prompts you for the scale factors.

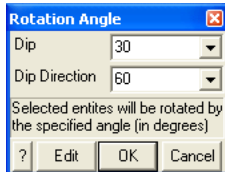

**Dip** - specifies the angle (in degrees) through which you want the selected entities to be rotated.

**Dip Direction** - specifies the azimuth (in degrees) at which the dip is to take place. The dip direction is  $90^\circ$  from the strike of the dip plane.

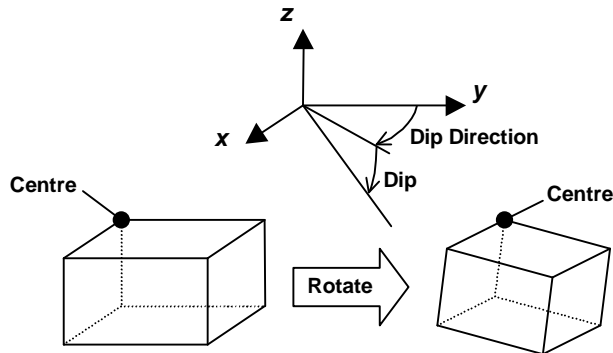

**Edit** - completes editing and invoked editing of the entity properties for the selected blocks.

**OK** - completes editing of the dip and dip direction and rotates the selected entities.

**Cancel** - aborts the rotating of entities.

Once you have completed any edit operation you have one chance to undo the modifications by selecting

 Undo

You can also restore the same selection set and modify the same set of entities again by selecting

 Redo

You can adjust the double click time using

[Tools > Double Click Time](#)

#### 4.5.4.8 Dump to File









Dumps selected entities to a file.

This routine can be initiated either by picking the  button or simple right-clicking on any entity. When you initiate this routine you will first be prompted to build a list of entities that you wish to dump



- If [Tools > Shift-key Selection](#) is checked, you must hold down the Shift-key to make multiple selections.
- By default, selected entities are added to the list, however if the Ctrl-key is held down, selected entities will be removed from the list.
- While holding down the Shift-key or Ctrl-key, you can drag open a crossing window.
- Use of this toolbar is detailed in [Build A List of Entities for Editing](#)
- Pressing the space-bar automatically activates the last edit function that was used.
- Holding the Alt-key when you right-click automatically repeats the last edit function that was used.

Once you have selected the desired entities, you can either pick any of the edit buttons:

-  [CAD > Edit > Entity Properties](#) Edit block type, colour, mining sequence,
-  [CAD > Edit > Erase Entities](#) Erase selected entities,
-  [CAD > Edit > Move Entities](#) Move selected entities,
-  [CAD > Edit > Copy Entities](#) Copy selected entities,
-  [CAD > Edit > Scale Entities](#) Scale selected entities,
-  [CAD > Edit > Rotate Azimuth](#) Rotate the azimuth of selected entities,
-  [CAD > Edit > Rotate Dip](#) Rotate the dip of selected entities,
-  [CAD > Edit > Dump to File](#) Dump selected entities to a file,
-  [CAD > Edit > Group](#) Group selected entities into a single block,

- double click on any vertex to execute the highlighted function,
- right click for a list of options.

You can adjust the double click time using

[Tools > Double Click Time](#)

#### 4.5.4.9 Group Entities

Group the selected entities into a single block. This is an advanced option that should only be used by experienced users.

At times you may need to erase or build individual surfaces, then group them together to form a single block. This function groups entities together to form seamless closed block from individual surfaces. Note that when using this operation the user must ensure that the grouped surfaces form a seamless, closed surface envelope with no internal surfaces. The presence of internal surfaces may cause errors.









The group function was implemented to allow advanced users to erase a few surface elements and rebuild them. It is also useful for joining surfaces together that are brought in from CAD packages. Note that the user is required to ensure that there are no internal surfaces and the surfaces you group together do form a seamless, closed surface envelope.

This routine can be initiated either by picking the  button or simple right-clicking on any entity. When you initiate this routine you will first be prompted to build a list of entities that you wish to group



- If [Tools > Shift-key Selection](#) is checked, you must hold down the Shift-key to make multiple selections.
- By default, selected entities are added to the list, however if the Ctrl-key is held down, selected entities will be removed from the list.
- While holding down the Shift-key or Ctrl-key, you can drag open a crossing window.
- Use of this toolbar is detailed in [Build A List of Entities for Editing](#)
- Pressing the space-bar automatically activates the last edit function that was used.
- Holding the Alt-key when you right-click automatically repeats the last edit function that was used.

Once you have selected the desired entities, you can either pick any of the edit buttons:

-  [CAD > Edit > Entity Properties](#) Edit block type, colour, mining sequence,
-  [CAD > Edit > Erase Entities](#) Erase selected entities,
-  [CAD > Edit > Move Entities](#) Move selected entities,
-  [CAD > Edit > Copy Entities](#) Copy selected entities,
-  [CAD > Edit > Scale Entities](#) Scale selected entities,
-  [CAD > Edit > Rotate Azimuth](#) Rotate the azimuth of selected entities,
-  [CAD > Edit > Rotate Dip](#) Rotate the dip of selected entities,
-  [CAD > Edit > Dump to File](#) Dump selected entities to a file,
-  [CAD > Edit > Group](#) Group selected entities into a single block,

- double click on any vertex to execute the highlighted function,
- right click for a list of options.

If any of the fields in the dialogue box read "Variable" it is because some of the surfaces you have selected have different properties for that field. In order to group the selected entities into a single block, all surfaces must have the same settings for all fields. Use  [CAD > Edit > Entity Properties](#) to do this.

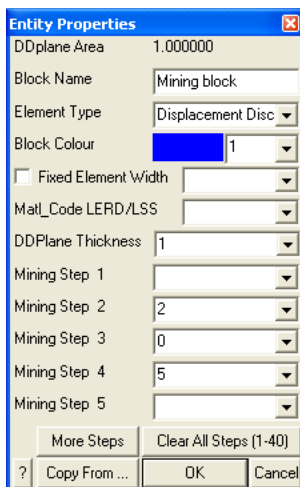

Once you have completed any edit operation you have one chance to undo the modifications by selecting

 Undo

You can also restore the same selection set and modify the same set of entities again by selecting

 Redo

You can adjust the double click time using

[Tools > Double Click Time](#)

#### 4.5.4.10 Stretch Vertices





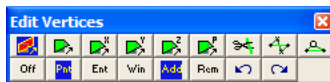



Adds an offset to selected vertices.

This routine can be initiated either by picking the  button or simply right-clicking on any vertex. When you initiate this routine you will first be prompted to build a list of vertices that you wish to stretch



- If [Tools > Shift-key Selection](#) is checked, you must hold down the Shift-key to make multiple selections.
- By default, selected entities are added to the list, however if the Ctrl-key is held down, selected entities will be removed from the list.
- While holding down the Shift-key or Ctrl-key, you can drag open a crossing window.
- Use of this toolbar is detailed in [Build A List of Vertices for Editing](#)
- Pressing the space-bar automatically activates the last edit function that was used.
- Holding the Alt-key when you right-click automatically repeats the last edit function that was used.

Once you have selected the desired entities, you can either pick any of the edit buttons:

-  [CAD > Edit > Stretch Vertices](#)
-  [CAD > Edit > Move Vertices to Point](#)
-  [CAD > Edit > Move Vertices to X](#)
-  [CAD > Edit > Move Vertices to Y](#)
-  [CAD > Edit > Move Vertices to Z](#)
-  [CAD > Edit > Move Vertices to Plane](#)
-  [CAD > Edit > Subdivide Construction Lines](#)
-  [CAD > Edit > Smooth Construction Lines](#)
-  [CAD > Edit > Remove Construction Vertex](#)

- double click on any vertex to execute the highlighted function,
- right click for a list of options.

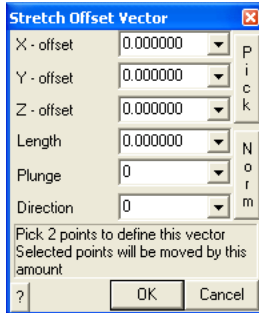

**X, Y and Z – offset** specify the components of the stretch vector.

- All selected vertices will be moved to the location specified by this offset.
- This requires that you select two points to define this vector.
- Once selected, the components of the offset vector are displayed in the dialogue box.

**Pick** activates the cursor cross-hairs allowing interactive selection of the offset vector from the model. This requires that you select two points to define this vector.

**Length, Plunge and Direction** - specify the components of the offset vector. All selected vertices will be moved by this amount.

**Norm** - activates the cursor allowing interactive selection of a surface to make the offset vector normal to.

To assist in visually selecting points from the model, all snap functions are available.

 [CAD > Snap](#)

Once selected, the components of the offset vector are displayed in the dialogue box.

**OK** - completes editing of the offset vector and stretches the selected vertices.

**Cancel** - aborts stretching of vertices.

Once you have completed any edit operation you have one chance to undo the modifications by selecting

 Undo

You can also restore the same selection set and modify the same set of entities again by selecting

 Redo

You can adjust the double click time using

[Tools > Double Click Time](#)

#### 4.5.4.11 Move Vertices to point









Moves selected vertices to a point.

This routine can be initiated either by picking the  button or simple right-clicking on any vertex. When you initiate this routine you will first be prompted to build a list of vertices that you wish to move.



- If [Tools > Shift-key Selection](#) is checked, you must hold down the Shift-key to make multiple selections.
- By default, selected entities are added to the list, however if the Ctrl-key is held down, selected entities will be removed from the list.
- While holding down the Shift-key or Ctrl-key, you can drag open a crossing window.
- Use of this toolbar is detailed in [Build A List of Vertices for Editing](#)
- Pressing the space-bar automatically activates the last edit function that was used.
- Holding the Alt-key when you right-click automatically repeats the last edit function that was used.

Once you have selected the desired entities, you can either pick any of the edit buttons:

-  [CAD > Edit > Stretch Vertices](#)
-  [CAD > Edit > Move Vertices to Point](#)
-  [CAD > Edit > Move Vertices to X](#)
-  [CAD > Edit > Move Vertices to Y](#)
-  [CAD > Edit > Move Vertices to Z](#)
-  [CAD > Edit > Move Vertices to Plane](#)
-  [CAD > Edit > Subdivide Construction Lines](#)
-  [CAD > Edit > Smooth Construction Lines](#)
-  [CAD > Edit > Remove Construction Vertex](#)

- double click on any vertex to execute the highlighted function,
- right click for a list of options.

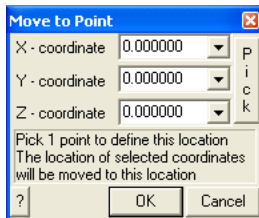

[X, Y and Z – coordinate](#) specify the coordinates of the point. All selected vertices will be moved to this point.

[Pick](#) - activates the cursor cross-hairs allowing interactive selection of the point from the model.

To assist in visually selecting points from the model, all snap functions are available.

 [CAD > Snap](#)

Once selected, the components of the offset vector are displayed in the dialogue box.

[OK](#) - completes editing of the offset vector and stretches the selected vertices.

[Cancel](#) - aborts stretching of vertices.

Once you have completed any edit operation you have one chance to undo the modifications by selecting

 Undo

You can also restore the same selection set and modify the same set of entities again by selecting

 Redo

You can adjust the double click time using

[Tools > Double Click Time](#)

#### 4.5.4.12 Move Vertices to X









Moves the X-coordinate of selected vertices.

This routine can be initiated either by picking the  button or simple right-clicking on any vertex. When you initiate this routine you will first be prompted to build a list of vertices that you wish to move.



- If [Tools > Shift-key Selection](#) is checked, you must hold down the Shift-key to make multiple selections.
- By default, selected entities are added to the list, however if the Ctrl-key is held down, selected entities will be removed from the list.
- While holding down the Shift-key or Ctrl-key, you can drag open a crossing window.
- Use of this toolbar is detailed in [Build A List of Vertices for Editing](#)
- Pressing the space-bar automatically activates the last edit function that was used.
- Holding the Alt-key when you right-click automatically repeats the last edit function that was used.

Once you have selected the desired entities, you can either pick any of the edit buttons:

-  [CAD > Edit > Stretch Vertices](#)
-  [CAD > Edit > Move Vertices to Point](#)
-  [CAD > Edit > Move Vertices to X](#)
-  [CAD > Edit > Move Vertices to Y](#)
-  [CAD > Edit > Move Vertices to Z](#)
-  [CAD > Edit > Move Vertices to Plane](#)
-  [CAD > Edit > Subdivide Construction Lines](#)
-  [CAD > Edit > Smooth Construction Lines](#)
-  [CAD > Edit > Remove Construction Vertex](#)

- double click on any vertex to execute the highlighted function,
- right click for a list of options.

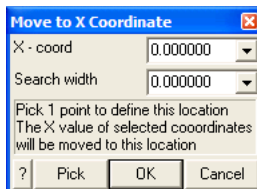

**X – coordinate** specify the X-coordinate of the point. The X-coordinate of all selected vertices (i.e. vertices in the list) will be moved to this value.

**Search width** all coordinates with the search width distance of the specified x-coordinate value will be moved even if they are not in the list.

**Pick** activates the cursor cross-hairs allowing interactive selection of the point from the model. To assist in visually selecting points from the model, all snap functions are available

To assist in visually selecting points from the model, all snap functions are available.



 [CAD > Snap](#)

Once selected, the components of the offset vector are displayed in the dialogue box.

**OK** - completes editing of the offset vector and stretches the selected vertices.

**Cancel** - aborts stretching of vertices.

Once you have completed any edit operation you have one chance to undo the modifications by selecting

 Undo

You can also restore the same selection set and modify the same set of entities again by selecting

 Redo

You can adjust the double click time using

[Tools > Double Click Time](#)

#### 4.5.4.13 Move Vertices to Y









Moves the Y-coordinate of selected vertices.

This routine can be initiated either by picking the  button or simple right-clicking on any vertex. When you initiate this routine you will first be prompted to build a list of vertices that you wish to move.



- If [Tools > Shift-key Selection](#) is checked, you must hold down the Shift-key to make multiple selections.
- By default, selected entities are added to the list, however if the Ctrl-key is held down, selected entities will be removed from the list.
- While holding down the Shift-key or Ctrl-key, you can drag open a crossing window.
- Use of this toolbar is detailed in [Build A List of Vertices for Editing](#)
- Pressing the space-bar automatically activates the last edit function that was used.
- Holding the Alt-key when you right-click automatically repeats the last edit function that was used.

Once you have selected the desired entities, you can either pick any of the edit buttons:

-  [CAD > Edit > Stretch Vertices](#)
-  [CAD > Edit > Move Vertices to Point](#)
-  [CAD > Edit > Move Vertices to X](#)
-  [CAD > Edit > Move Vertices to Y](#)
-  [CAD > Edit > Move Vertices to Z](#)
-  [CAD > Edit > Move Vertices to Plane](#)
-  [CAD > Edit > Subdivide Construction Lines](#)
-  [CAD > Edit > Smooth Construction Lines](#)
-  [CAD > Edit > Remove Construction Vertex](#)

- double click on any vertex to execute the highlighted function,
- right click for a list of options.

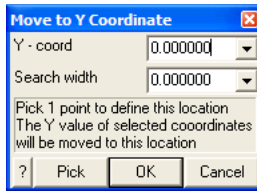

**Y – coordinate** specify the Y-coordinate of the point. The Y-coordinate of all selected vertices (i.e. vertices in the list) will be moved to this value.

**Search width** all coordinates with the search width distance of the specified y-coordinate value will be moved even if they are not in the list.

**Pick** activates the cursor cross-hairs allowing interactive selection of the point from the model. To assist in visually selecting points from the model, all snap functions are available

To assist in visually selecting points from the model, all snap functions are available.

 [CAD > Snap](#)

Once selected, the components of the offset vector are displayed in the dialogue box.

**OK** - completes editing of the offset vector and stretches the selected vertices.

**Cancel** - aborts stretching of vertices.

Once you have completed any edit operation you have one chance to undo the modifications by selecting

 Undo

You can also restore the same selection set and modify the same set of entities again by selecting

 Redo

You can adjust the double click time using

[Tools > Double Click Time](#)

#### 4.5.4.14 Move Vertices to Z









Moves the Z-coordinate of selected vertices.

This routine can be initiated either by picking the  button or simple right-clicking on any vertex. When you initiate this routine you will first be prompted to build a list of vertices that you wish to move.



- If [Tools > Shift-key Selection](#) is checked, you must hold down the Shift-key to make multiple selections.
- By default, selected entities are added to the list, however if the Ctrl-key is held down, selected entities will be removed from the list.
- While holding down the Shift-key or Ctrl-key, you can drag open a crossing window.
- Use of this toolbar is detailed in [Build A List of Vertices for Editing](#)
- Pressing the space-bar automatically activates the last edit function that was used.
- Holding the Alt-key when you right-click automatically repeats the last edit function that was used.

Once you have selected the desired entities, you can either pick any of the edit buttons:

-  [CAD > Edit > Stretch Vertices](#)
-  [CAD > Edit > Move Vertices to Point](#)
-  [CAD > Edit > Move Vertices to X](#)
-  [CAD > Edit > Move Vertices to Y](#)
-  [CAD > Edit > Move Vertices to Z](#)
-  [CAD > Edit > Move Vertices to Plane](#)
-  [CAD > Edit > Subdivide Construction Lines](#)
-  [CAD > Edit > Smooth Construction Lines](#)
-  [CAD > Edit > Remove Construction Vertex](#)

- double click on any vertex to execute the highlighted function,
- right click for a list of options.

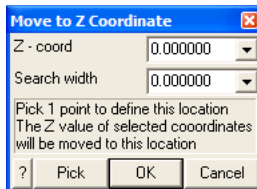

**Z – coordinate** specify the Z-coordinate of the point. The Z-coordinate of all selected vertices (i.e. vertices in the list) will be moved to this value.

**Search width** all coordinates with the search width distance of the specified z-coordinate value will be moved even if they are not in the list.

**Pick** activates the cursor cross-hairs allowing interactive selection of the point from the model. To assist in visually selecting points from the model, all snap functions are available

To assist in visually selecting points from the model, all snap functions are available.

 [CAD > Snap](#)

Once selected, the components of the offset vector are displayed in the dialogue box.

**OK** - completes editing of the offset vector and stretches the selected vertices.

**Cancel** - aborts stretching of vertices.

Once you have completed any edit operation you have one chance to undo the modifications by selecting

 Undo

You can also restore the same selection set and modify the same set of entities again by selecting

 Redo

You can adjust the double click time using

[Tools > Double Click Time](#)

#### 4.5.4.15 Move Vertices to Plane









Moves the selected vertices to a plane. Vertices are moved in the direction normal (or a user specified direction) to the plane.

This routine can be initiated either by picking the  button or simple right-clicking on any vertex. When you initiate this routine you will first be prompted to build a list of vertices that you wish to move.



- If [Tools > Shift-key Selection](#) is checked, you must hold down the Shift-key to make multiple selections.
- By default, selected entities are added to the list, however if the Ctrl-key is held down, selected entities will be removed from the list.
- While holding down the Shift-key or Ctrl-key, you can drag open a crossing window.
- Use of this toolbar is detailed in [Build A List of Vertices for Editing](#)
- Pressing the space-bar automatically activates the last edit function that was used.
- Holding the Alt-key when you right-click automatically repeats the last edit function that was used.

Once you have selected the desired entities, you can either pick any of the edit buttons:

-  [CAD > Edit > Stretch Vertices](#)
-  [CAD > Edit > Move Vertices to Point](#)
-  [CAD > Edit > Move Vertices to X](#)
-  [CAD > Edit > Move Vertices to Y](#)
-  [CAD > Edit > Move Vertices to Z](#)
-  [CAD > Edit > Move Vertices to Plane](#)
-  [CAD > Edit > Subdivide Construction Lines](#)
-  [CAD > Edit > Smooth Construction Lines](#)
-  [CAD > Edit > Remove Construction Vertex](#)

- double click on any vertex to execute the highlighted function,
- right click for a list of options.

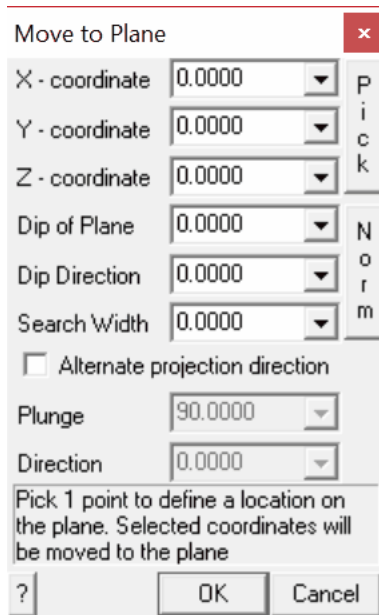

**X Y Z – coordinate** specify the coordinates of any point on the plane.

**Pick** activates the cursor cross-hairs allowing interactive selection of the x y z coordinates of the point on the plane from the model. To assist in visually selecting points from the model, all snap functions are available

**Dip of Plane** specify the dip of the plane (positive down in degrees).

**Dip Direction** specify the azimuth of the dip vector (degrees).

**Norm** - activates the cursor allowing interactive selection of a surface. The dip and dip direction of the plane will be set parallel to the selected surface.

**Search width** all coordinates with the search width distance of the specified plane will be moved even if they are not in the list.

**Alternate projection direction** - if not checked then all points will be projected on the selected plane in the direction normal to the plane. If checked, then the user can specify their own desired projection direction.

**Plunge** - user specified projection direction.

**Direction** - user specified projection direction.

To assist in visually selecting points from the model, all snap functions are available.

 [CAD > Snap](#)

Once selected, the components of the offset vector are displayed in the dialogue box.

**OK** - completes editing of the offset vector and stretches the selected vertices.

**Cancel** - aborts stretching of vertices.

Once you have completed any edit operation you have one chance to undo the modifications by selecting

 Undo

You can also restore the same selection set and modify the same set of entities again by selecting

 Redo

You can adjust the double click time using

[Tools > Double Click Time](#)

#### 4.5.4.16 Subdivide Edges









Inserts vertices on block edges or construction line edges (also see  [CAD > Edit > Remove Construction Vertex](#)).

This routine can be initiated either by picking the  button or simply right-clicking on any edge. When you initiate this routine you will first be prompted to build a list of locations where you wish to insert vertices.



- If [Tools > Shift-key Selection](#) is checked, you must hold down the Shift-key to make multiple selections.
- By default, selected entities are added to the list, however if the Ctrl-key is held down, selected entities will be removed from the list.
- While holding down the Shift-key or Ctrl-key, you can drag open a crossing window.
- Use of this toolbar is detailed in [Build A List of Vertices for Editing](#)
- Pressing the space-bar automatically activates the last edit function that was used.
- Holding the Alt-key when you right-click automatically repeats the last edit function that was used.

Once you have selected the desired entities, you can either pick any of the edit buttons:

-  [CAD > Edit > Stretch Vertices](#)
-  [CAD > Edit > Move Vertices to Point](#)
-  [CAD > Edit > Move Vertices to X](#)
-  [CAD > Edit > Move Vertices to Y](#)
-  [CAD > Edit > Move Vertices to Z](#)
-  [CAD > Edit > Move Vertices to Plane](#)
-  [CAD > Edit > Subdivide Construction Lines](#)
-  [CAD > Edit > Smooth Construction Lines](#)
-  [CAD > Edit > Remove Construction Vertex](#)

- double click on any vertex to execute the highlighted function,
- right click for a list of options.

Once you have completed any edit operation you have one chance to undo the modifications by selecting

 Undo

You can also restore the same selection set and modify the same set of entities again by selecting

 Redo

You can adjust the double click time using

[Tools > Double Click Time](#)

Notes:

- The location of all points along construction lines can be viewed by setting the [View > Render > Cline dot radius](#) parameter.
- Before using this trace smoothing function, construction lines should be cleaned up using the [CAD > Pack and Renumber Clines](#) function.
- You can adjust the double click time using [Tools > Double Click Time](#).

#### 4.5.4.17 Smooth Construction Lines









Smooths construction lines by eliminating corner points (also see  [CAD > Edit > Remove Construction Vertex](#)).

This routine can be initiated either by picking the  button or simple right-clicking on any vertex. When you initiate this routine you will first be prompted to build a list of vertices that you wish to smooth.



- If [Tools > Shift-key Selection](#) is checked, you must hold down the Shift-key to make multiple selections.
- By default, selected entities are added to the list, however if the Ctrl-key is held down, selected entities will be removed from the list.
- While holding down the Shift-key or Ctrl-key, you can drag open a crossing window.
- Use of this toolbar is detailed in [Build A List of Vertices for Editing](#)
- Pressing the space-bar automatically activates the last edit function that was used.
- Holding the Alt-key when you right-click automatically repeats the last edit function that was used.

Once you have selected the desired entities, you can either pick any of the edit buttons:

-  [CAD > Edit > Stretch Vertices](#)
-  [CAD > Edit > Move Vertices to Point](#)
-  [CAD > Edit > Move Vertices to X](#)
-  [CAD > Edit > Move Vertices to Y](#)
-  [CAD > Edit > Move Vertices to Z](#)
-  [CAD > Edit > Move Vertices to Plane](#)
-  [CAD > Edit > Subdivide Construction Lines](#)
-  [CAD > Edit > Smooth Construction Lines](#)
-  [CAD > Edit > Remove Construction Vertex](#)

- double click on any vertex to execute the highlighted function,
- right click for a list of options.

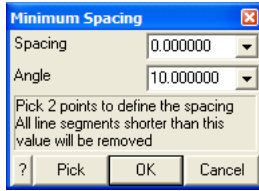

The **Spacing** value limits the minimum space between points. For example if the **Spacing** was specified as 2m and the trace length between points 4 and 5 in the following figure was 1.5m, point 4 would be removed and replaced by a straight line between points 3 and 5.

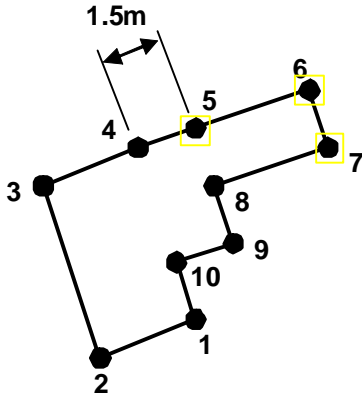

A zero value for this parameter indicates that it will not be used.

The **Angle** value limits the minimum angle between successive line segments. For example if the **Angle** was specified as  $10^\circ$  and the direction of line segment 3-4 was  $7^\circ$  different than the direction of line segment 4-5 in the following figure, point 4 would be removed and replaced by a straight line between points 3 and 5.

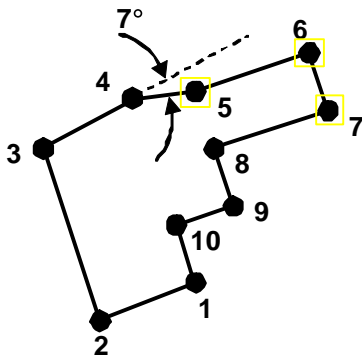

A zero value for this parameter indicates that it will not be used.

**OK** - completes editing of the offset vector and stretches the selected vertices.

**Cancel** - aborts stretching of vertices.

Once you have completed any edit operation you have one chance to undo the modifications by selecting





Once you have completed any edit operation you have one chance to undo the modifications by selecting

 Undo

You can also restore the same selection set and modify the same set of entities again by selecting

 Redo

You can adjust the double click time using

[Tools > Double Click Time](#)

Notes:

- The location of all points along construction lines can be viewed by setting the [View > Render > Cline dot radius](#) parameter.
- Before using this trace smoothing function, construction lines should be cleaned up using the [CAD > Pack and Renumber Clines](#) function.
- You can adjust the double click time using [Tools > Double Click Time](#).

## 4.5.5 Grid Selection

Selects a field point grid for viewing.



Analysis results (stresses, strains and displacements) can be contoured on element surfaces and on field point grids.

With OpenGL enabled ([Tools > OpenGL](#)), all grids can be displayed simultaneously. Without OpenGL enabled, only two grids can be displayed simultaneously.

 Hide All - Hides all grids.

 Unhide All - Unhide all grids.

The user can construct multiple field point grid planes using

 [CAD > Build > Grid Plane](#)

 [CAD > Build > Grid Line](#)

Individual grid selection buttons can be placed on the view toolbar if desired using

[Tools > View Toolbar Configure](#)

## 4.5.6 Digitizer Setup

Setup the digitizer.

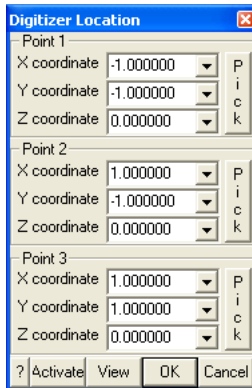

The digitizing plane is uniquely scaled, located and oriented by specifying 3 points on the drawing to be digitized.

The procedure for doing this is to:

1. select 3 points on the drawing,
2. enter the coordinates of each point,
3. then pick the points with the digitizer puck.
4. Pick activates the digitizer puck to allow selection of each point.

 [CAD > Digitizer > Activate](#) toggles activation of the digitizer for selecting points from a drawing. This button can be placed on the CAD toolbar using [Tools > CAD Toolbar > Configure](#).

[View](#) - repositions the view so you can see the digitizer plane superimposed with the model.

Digitizer support is available for any digitizer that can be setup to control cursor movements in absolute mode (i.e. providing a one to one correspondence of digitizer movement with cursor position). Most new digitizers ship with their own software drivers that provide this support. An alternative is to use the following software that supports most digitizers:

Virtual Tablet Interface  
Digitizer Technology Company  
16541 Redmond Way, Suite 195C  
Redmond, Washington USA 98052  
Tel: 206 868 3246  
Fax: 206 885 7704

## 4.5.7 Resequence Block Links

When importing models from other CAD programs, it is important to provide Map3D with some way of identifying how blocks are formed.

The best way is simply to adjacent blocks different colour numbers, then Map3D can easily determine which surfaces belong to each block.

Alternatively you can specify a unique block name for each surface.

In cases where this is not possible, a new routine is now available that attempts to determine which surface belong to adjacent blocks.

This is done by searching for surface connections at common corners with the assumption that

surfaces are provided in some sort of consistent sequence.  
For example, surfaces 1-12 all form a block, surface 13-24 form another blocks etc.  
The new "CAD > Resequence Block Links" routine executes this processing.  
Note that this routine should only be used as a last resort to unscramble improperly constructed models.

#### 4.5.8 Recheck Blocks for Errors

Re-analyses the model to detect gaps, duplicates, construction errors etc.  
This is the same procedure that is executed during file load.

#### 4.5.9 Pack and Renumber Blocks

Packs and rennumbers all model entities.

Coordinate points that are very close to one another are merged together. Corners of blocks that share the same location will use the same coordinate point number and hence will move together in any coordinate editing operation ([Cad > Edit](#)). This feature is useful for eliminating small gaps and overlaps between adjacent surfaces and blocks.

When you initiate this function you will be prompted to specify a pack search radius

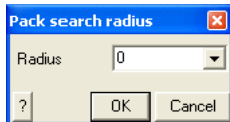

Radius this value is used to merge points that are close to one another. A zero value for this parameter indicates that it will not be used, and instead Map3D will merge points if they are within a search radius of 1000th of the edge length from the line. Extreme caution should be used when specifying a non-zero value for this parameter since large values can cause more problems then it will fix by merging too many points together.

Any unused coordinate numbers are removed from the list of coordinates.

Blocks can be unpacked using the [CAD > Unpack Blocks](#) function.

#### 4.5.10 Unpack Blocks

Unpacks all model entities.

All block corners will be given there own coordinate point numbers and hence will move separately in any coordinate editing operation ([Cad > Edit](#)).

Blocks can be packed using the [CAD > Pack and Renumber Blocks](#) function.

Also see [CAD > Unpack Surfaces](#) function.

#### 4.5.11 Unpack Surfaces

Unpacks all model entities.

All surface corners will be given there own coordinate point numbers and hence will move separately in any coordinate editing operation ([Cad > Edit](#)).

Blocks can be packed using the [CAD > Pack and Renumber Blocks](#) function.

Also see [CAD > Unpack Blocks](#) function.

#### 4.5.12 UnGroup DDs

Un-Groups all DDs.

Each DD will be given its own block number and hence can be edited separately using any entity editing operation ([Cad > Edit](#)).

DD's can be re-Grouped using the [CAD > Edit > Group Entities](#) function.

#### 4.5.13 Pack and Renumber Clines

Packs and rennumbers all construction lines.

Coordinate points that are very close to one another are merged together. Corners of construction lines that share the same location will use the same coordinate point number and hence will move together in any coordinate editing operation ([Cad > Edit](#)). This feature is useful for eliminating small gaps and overlaps between adjacent construction lines.

All possible construction line segments of the same colour will be linked together to form contiguous lines between intersection points.

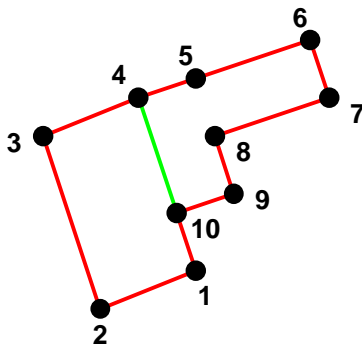

In this example, 3 line segments will be formed consisting of the following groupings of points

- Line segment 1: 10, 1, 2, 3, 4.
- Line segment 2: 4, 5, 6, 7, 8, 9, 10.
- Line segment 3: 4, 10.

When you initiate this function you will be prompted to specify a pack search radius

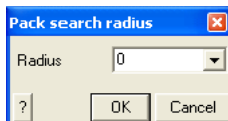

Radius this value is used to merge points that are close to one another. A zero value for this parameter indicates that it will not be used, and instead Map3D will merge points if they are within a

search radius of 1000th of the edge length from the line. Extreme caution should be used when specifying a non-zero value for this parameter since large values can cause more problems than it will fix by merging too many points together.

Any unused coordinate numbers are removed from the list of coordinates.

This function should be used before using the [CAD > Edit > Smooth Construction lines](#) function.

This function should be used before using the [CAD > Snap > Trace Cline Snap](#) function.

Construction lines can be unpacked using the [CAD > Unpack Clines](#) function.

#### 4.5.14 Unpack Clines

Unpacks all construction lines.

All corners will be given their own coordinate point numbers and hence will move separately in any coordinate editing operation ([Cad > Edit](#)).

Construction lines can be packed using the [CAD > Pack and Renumber Clines](#) function.

## 4.6 Tools

### 4.6.1 Mouse Options

#### 4.6.1.1 Mouse Buttons

Allows you to specify custom mouse rotation, translation and zoom functionality.

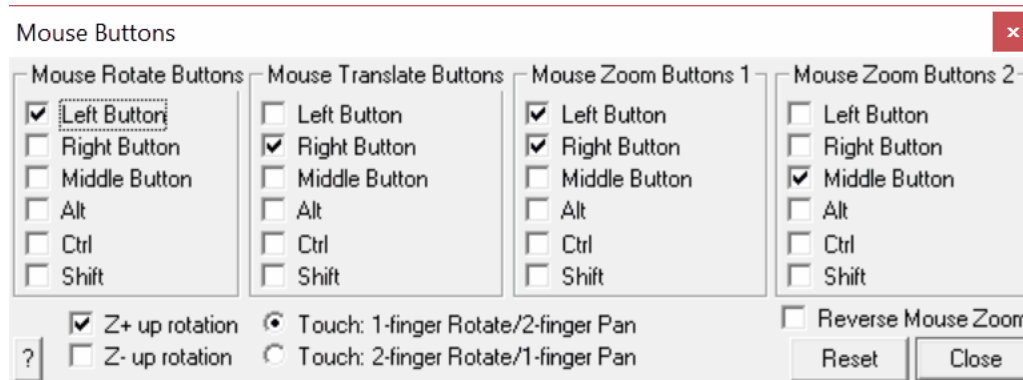

Note that a maximum of two buttons can be specified for each function. These buttons will be saved from session to session.

[Z+ up rotation](#) - specifies that the Z+ axis is constrained to point vertically such that when the the Z+ axis points upwards, dragging the mouse to the left rotates the model to the left.

[Z- up rotation](#) - reverses the above assumption. In this case specifies that the Z+ axis is constrained to point vertically such that when the the Z+ axis points upwards, dragging the mouse to the left rotates the model to the right.

[Touch: 1-finger Rotate/2-finger Pan](#) - touch screen controls set for 1-finger drag rotates the model and 2-finger drag pans the model.

[Touch: 2-finger Rotate/1-finger Pan](#) - touch screen controls set for 2-finger drag rotates the model and 1-finger drag pans the model.

[Touch Zoom](#) - two finger pinch zooms the model.

[Reverse Mouse Wheel](#) - reverses the action of the mouse wheel such that forward rotation zooms the model in instead of out.

#### 4.6.1.2 Double Click Time

Specifies the amount time (in milliseconds) between double mouse clicks.

Double clicks are used to activate edit functions

 [CAD > Edit](#)

#### 4.6.1.3 Drag Wait Time

Specifies the amount time (in milliseconds) you must hold down a mouse button before the drag mouse pointer  appears.

The drag mouse pointer is used to [rotate](#) and [translate and zoom](#) the model.









### 4.6.2 Toolbars

#### 4.6.2.1 Rotation Toolbar

Activate the rotation toolbar.



The model can be rotated by using these buttons or by [dragging the orientation icon](#) around to the desired position.

-  Rotate Counter clockwise (Insert key)
-  Rotate Up (Home key or shift+up arrow)
-  Rotate Clockwise (Page Up key)
-  Rotate Left (Delete key or shift+left arrow)
-  Rotate Down (End key or shift+down arrow)
-  Rotate Right (Page Down key or shift+right arrow)
-  [View > Centre of Rotation](#)
-  [View > Rotation Increment](#)

Notes:

If the rotation toolbar is not visible it can be activated with

Tools > Rotation Toolbar

Before rotating the model you should set the desired centre of rotation

 [View > Centre of Rotation](#)

#### 4.6.2.2 Translation Toolbar

Activate the translation toolbar.



The model can be translated by using these buttons or by [dragging the model](#) to the desired position.

- Zoom In (Enter or "+" key)
- Translate Up (up arrow)
- Zoom Out (Ctrl+Enter or "-" key)
- Translate Left (left arrow)
- Translate Down (down arrow)
- Translate Right (right arrow)
- View > Zoom Factor
- View > Translation Increment

Notes:

If the translation toolbar is not visible it can be activated with

Tools > Translation Toolbar

Before zooming in

- Zoom In

you should set the desired centre of rotation

- [View > Centre of Rotation](#)

#### 4.6.2.3 Contour Toolbar

Activate the contouring toolbar – after Map3D BEM analysis.

The default configuration for this toolbar is as follows:



This toolbar is meant to provide quick access to commonly used stress parameters.

- [Plot > Stress > S1](#) Major Principal Stress
- [Plot > Stress > S3](#) Minor Principal Stress
- [Plot > Stress > Tmax](#) Maximum Shear Stress
- [Plot > Stress](#) activates the stress toolbar. This toolbar contains all stress components.
- [Plot > Surface Components](#) activates the surface toolbar. This toolbar contains all surface components.
- [Plot > Strength Factors](#) activates the strength factor toolbar. This toolbar contains all strength parameter components.
- [Plot > Stress > User](#) User defined stress plot.
- [Plot > Range](#) specifies the contour range (minimum, maximum, interval ...) of the currently plotted contour.
- [Plot > Grid Selection](#) Activate the grid selection toolbar.
- [Plot > Surface Components > Options](#) specifies contour plot options (trajectories, contour lines ...).



 [Tools > Contouring Toolbar Configure](#) add or remove buttons from the contouring toolbar.

Notes:

Buttons can be moved around on the toolbar simply by holding down the left mouse button and dragging the button to the desired location.

The contouring toolbar can only be activated after the model building - CAD Stage

[Map3D Analysis Stages](#).

#### 4.6.2.4 Configure Contour Toolbar

Adds or remove buttons from the contouring toolbar.

Simply check or uncheck the desired item to add or remove the desired item from the toolbar.

Notes:

The contouring toolbar can only be activated

[Tools > Contouring toolbar](#)

after the model building - CAD Stage

[Map3D Analysis Stages](#).

Buttons can be moved around on the toolbar simply by holding down the left mouse button and dragging the button to the desired location.

The toolbar configuration is saved between analyses in the map3d.ini file.

#### 4.6.2.5 Solve Toolbar

Activate the solve toolbar – during Map3D BEM analysis.

The default configuration for this toolbar is as follows:



This toolbar is meant to provide quick access to parameters that are important during the [solution stage](#) of the Map3D BEM analysis

[Analysis > BEM Analysis](#)

 [Plot > Surface Components > Serr Stress Error](#)

 [Plot > Surface Components > Ferr Failure Error](#)

 [Plot > Surface Components > Shear Stress](#)

 [Plot > Surface Components > Normal Stress](#)

 [Plot > Surface Components > Shear Displacement \(Ride\)](#)

 [Plot > Surface Components](#) activates the surface toolbar containing all surface components.

 [Plot > Range](#) specifies the contour range (minimum, maximum, interval ...) of the currently plotted contour.

 [Plot > Surface Components > Options](#) specifies contour plot options (trajectories, contour lines ...).

 [Tools > Solve Toolbar Configure](#) add or remove buttons from the solve toolbar.

Notes:

During analysis, the solve toolbar is displayed when you suspend the analysis

[Analysis > Suspend.](#)

If this option is not checked the solve toolbar will not be activated when you suspend the Map3D BEM analysis.

Buttons can be moved around on the toolbar simply by holding down the left mouse button and dragging the button to the desired location.

The solve toolbar can only be activated after the model building - CAD Stage

[Map3D Analysis Stages.](#)

Related Topics:

[Analysis > Auto Plot.](#)

[Analysis > Auto Range.](#)

#### 4.6.2.6 Configure Solve Toolbar

Adds or remove buttons from the solve toolbar.

Simply check or uncheck the desired item to add or remove the desired item from the toolbar.

Notes:

The solve toolbar can only be activated

[Tools > Solve toolbar](#)

after the model building - CAD Stage

[Map3D Analysis Stages](#)

During analysis, the solve toolbar is displayed when you suspend the analysis

[Analysis > Suspend](#)

Buttons can be moved around on the toolbar simply by holding down the left mouse button and dragging the button to the desired location.

The toolbar configuration is saved between analyses in the map3d.ini file.

#### 4.6.2.7 View Toolbar

Activates the view toolbar.

The default configuration for this toolbar is as follows





This toolbar provides quick access to various viewing functions.

 [View > Centre of Rotation](#) Sets the centre of rotation. This point remains stationary while you rotate and zoom the display.

 [View > Zoom](#) activates a graphical zoom window. You will be prompted to select the two

corners of the window by picking each with a single mouse click.

 [View > Pan](#) activates a graphical pan. You will be prompted to select the two ends of the pan vector by picking each with a single mouse click.

 [View > Length](#) activates a graphical length measuring tool. You will be prompted to select the two ends of the length vector by picking each with a single mouse click. These points must be selected on the model or on a contour. The length, dip and dip direction of the selected vector is reported. If you hold down the shift key while selecting points, you can define a line composed of multiple segments and obtain the total length. If you define a closed polygonal shape (by holding down the shift key while selecting points) on a contour plot, the average contour value within the polygon will be reported (see [Plot > Polygon Box](#)). Simple rectangular window shapes can be defined by holding the shift key and dragging open a window.

 [View > Hide](#) activates the hide toolbar.

 [View > Hide Block Colours](#) activates the hide block colour toolbar.

 [View > Hide CLine Colours](#) activates the hide construction line colour toolbar.

 [File > Mining Step](#) activates the mining step selection toolbar.

 [Tools > View Toolbar Configure](#) adds or removes buttons from the view toolbar.

Notes:

Buttons can be moved around on the toolbar simply by holding down the left mouse button and dragging the button to the desired location.

#### 4.6.2.8 Configure View Toolbar

Adds or remove buttons from the view toolbar.

Simply check or uncheck the desired item to add or remove the desired item from the toolbar.

Notes:

Buttons can be moved around on the toolbar simply by holding down the left mouse button and dragging the button to the desired location.

The toolbar configuration is saved between analyses in the map3d.ini file.

#### 4.6.2.9 CAD Toolbar

Activate the CAD toolbar.

The default configuration for this toolbar is as follows:

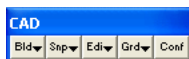



This toolbar is meant to provide quick access to CAD functions that are used in the [model building and editing stage](#) of the Map3D BEM analysis

[Analysis > Go to CAD](#)

 [CAD > Build](#) Activate the build toolbar for building new model entities.

 [CAD > Snap](#) Activate the snap toolbar for setting the snap mode.

 [CAD > Edit](#) Activate the edit toolbar for modifying model entities.

 [CAD > Grid Selection](#) Activate the grid selection toolbar for displaying grids.

 [Tools > CAD Toolbar > Configure](#) Add or remove buttons.

Notes:

The CAD toolbar is only displayed during the model building and editing stage of the analysis

[Analysis > Go to CAD](#)

If this option is not checked the CAD toolbar will not be activated during the model building and editing stage.

Buttons can be moved around on the toolbar simply by holding down the left mouse button and dragging the button to the desired location.

Related Topics:

[Map3D Analysis Stages](#)

#### 4.6.2.10 Configure CAD Toolbar

Adds or remove buttons from the CAD toolbar.

Simply check or uncheck the desired item to add or remove the desired item from the toolbar.

Notes:

The Cad toolbar can only be activated

[Tools > CAD toolbar](#)

during the model building - CAD Stage

[Map3D Analysis Stages](#)

Buttons can be moved around on the toolbar simply by holding down the left mouse button and dragging the button to the desired location.

The toolbar configuration is saved between analyses in the map3d.ini file.

#### 4.6.2.11 Block Colours

Assigns custom colours for rendering blocks.

Map3D uses 16 base colours for rendering.

The user can assign any desired colour to the base colours and Map3D automatically generates shades of these for rendering.

The colours are used as follows:

- Colour 0 - screen background colour.
- Colour 1-4 – rubber band and marker colours.
- Colour 5 – foreground colour, used for text, block outlines, trajectory symbols and grid lines.
- Colour 6 – block colour number 1, 11, 21, 31, ...
- Colour 7 - block colour number 2, 12, 22, 32, ...
- Colour 8 - block colour number 3, 13, 23, 33, ...
- Colour 9 - block colour number 4, 14, 24, 34, ...
- Colour 10 - block colour number 5, 15, 25, 35, ...
- Colour 11 - block colour number 6, 16, 26, 36, ...
- Colour 12 - block colour number 7, 17, 27, 37, ...

- Colour 13 - block colour number 8, 18, 28, 38, ...
- Colour 14 - block colour number 9, 19, 29, 39, ...
- Colour 15 - block colour number 10, 20, 30, 40, ...

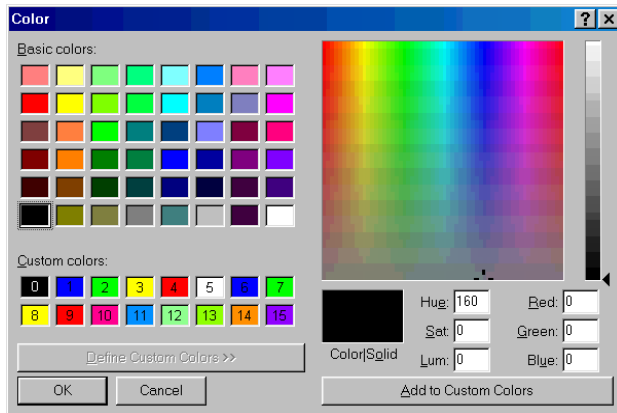

Reassigning a colour is a three step process:

1. Pick the colour you want to redefine from one of the "Custom Colors".
2. Set the new colour you desire by picking from the "Basic Colors:", picking from the "Color Matrix", or by setting the "Hue: Sat: Lum: Red: Green: Blue:".
3. Push the "Add to Custom Colors" button.

All colours can be reset to the original Map3D default values by selecting

[Tools > Set Default Block Colours](#)

The custom colours are saved between analyses in the map3d.ini file.

#### 4.6.2.12 Contour Colours

Assigns custom colours for rendering contours.

Map3D uses 16 base colours for contouring.

The colours are used as follows:

- Colour 0 - screen background colour.
- Colour 1 – below range contour colour.
- Colour 2 through 11 – contour colours.
- Colour 12 above range contour colour.
- Colour 13 – Tension cutoff colour.
- Colour 15 – foreground colour, used for text, block outlines, trajectory symbols and grid lines.

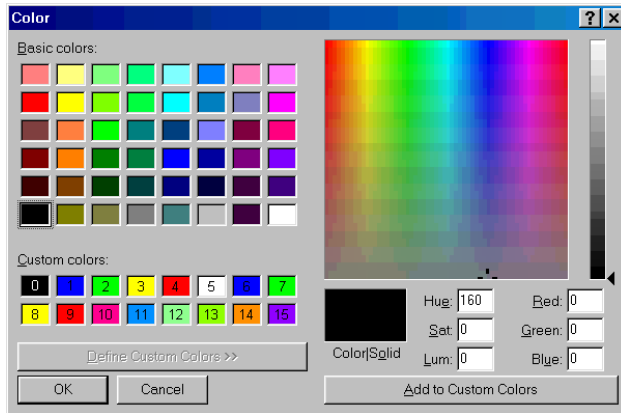

Reassigning a colour is a three step process:

1. Pick the colour you want to redefine from one of the "Custom Colors".
2. Set the new colour you desire by picking from the "Basic Colors:", picking from the "Color Matrix", or by setting the "Hue: Sat: Lum: Red: Green: Blue:".
3. Push the "Add to Custom Colors" button.

The custom colours are saved between analyses in the map3d.ini file.

Contour colours can be set to Map3D default values by selecting

[Tools > Set Contour Colours](#)

#### 4.6.2.13 Set Default Block Colours

Resets all colours to the original Map3D default values.

Custom colours can be set using

[Tools > Custom Colours](#)

#### 4.6.2.14 Set Contour Colours 1

Resets all colours to the original Map3D default values.

Custom colours can be set using

[Tools > Contour Colours](#)

#### 4.6.2.18 Configure Button Font

Assigns a custom button font, size, colour etc.

Map3D uses the "Windows System Font" to draw all buttons.

The user can redefine this font and its display characteristics.

The font can be reset to the original Map3D default value by selecting

[Tools > Reset Default Font](#)

The custom font is saved between analyses in the map3d.ini file.

#### 4.6.2.19 Reset Default Font

Resets the button font back to the original Map3D default value.

A custom font can be set using

[Tools > Configure Button Font](#)

#### 4.6.2.20 Small Size Buttons

Allows you to set the toolbar button size.

### 4.6.3 Assign Hotkeys

Allows you select use defined hotkeys.

For example to assign the F5 key to activate the Build > Cline function you would assign the function key as follows:

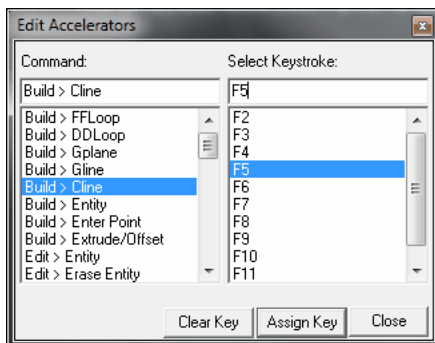

Note that function key assignments are saved from session to session the Map3D.cfg file.

### 4.6.4 OpenGL

#### 4.6.4.1 OpenGL <On/Off>

Enables OpenGL support.

OpenGL is an industry standard high-quality 3D graphics rendering interface. The main advantages in using OpenGL are hardware acceleration of the graphics display and support for z-buffering. Of course you must have a graphics adapter that supports OpenGL and have the OpenGL display driver installed to get hardware acceleration.

See [Tools > OpenGL Parameters](#) to view OpenGL setup.

See [Tools > OpenGL Antialiasing](#) to smooth lines.

#### 4.6.4.2 OpenGL Parameters

Reports on OpenGL setup:

[Support OpenGL](#) – indicates whether an OpenGL driver is installed and enabled.

[Driver or Hardware Support](#) - indicates whether an OpenGL is supported by your graphics adapter.

[Double Buffered](#) – indicates that there is sufficient memory to support double buffering.

[Color Buffer Bits](#) – indicates the number of bits used for the colour buffer.

[Depth Buffer Bits](#) – indicates the number of bits used for the z-buffer.

#### 4.6.4.3 OpenGL Antialiasing

Enables smoothing of points, lines and edges of polygons.

This OpenGL feature provides improved appearance but slows rendering.

[View > Render > Line Width](#) can be used to enable drawing of wider lines. This would also help smooth line drawing with as much impact on performance.

#### 4.6.4.4 OpenGL Redraw

Enables OpenGL redrawing of the screen when the window needs to be refreshed.

The Map3D display window must be refreshed every time a dialogue box is moved or removed. This refresh can either be done by saving the display window to a back buffer (this option is not checked), or by simply redrawing the screen (this option is checked).

This option should normally be checked, but can be disabled for problem graphics adaptors.

#### 4.6.4.5 OpenGL Pick

Enables OpenGL to locate graphics entities on the screen.

When you left click on an entity Map3D must determine which entity you have selected. This can be determined either by OpenGL or internally by Map3D.

This option should normally be checked, but can be disabled for problem graphics adaptors.

#### 4.6.4.6 OpenGL Crosshairs

Toggles between OpenGL and Windows API drawing of cursor crosshairs.

This option should normally be checked, but can be disabled for problem graphics adaptors.

To completely disable drawing of the cursor crosshairs select [Tools > Crosshairs](#).



#### 4.6.4.7 OpenGL Interactive Edit

Enables interactive OpenGL drawing of modified shapes during editing operations.

This option should normally be checked, but can be disabled for problem graphics adaptors.

#### 4.6.5 Disk Performance Test

Tests the performance of the hard disk system.

This test simulates the behaviour of Map3D during the solution stage of the BEM analysis.

**Buffer Size** - Size of the buffer used for reads and write to disk. Map3D uses a 256K buffer for its file read and writes.

**Write Through** - Instructs the system to write through any intermediate cache and go directly to disk. Map3D uses "Write Through" for its file writes.

**No Buffering** - Instructs the system to write to the file with no intermediate buffering or caching. Map3D uses "No Buffering" for its file writes.

**Asynchronous I/O** - Instructs the system to enable more than one read and/or write operation to be performed simultaneously. This option is only supported under Window NT/2000. Map3D can be instructed to use this feature with

[Analysis > Options > Async I/O](#)

**Size MB** - File size used for the test. It is recommended that this test be done with a large file size (considerably larger than the amount of RAM).

**Drive** - Disk drive used for the test.

The important results are:

**Write rate** - the number of MBytes written to the disk per second. You should expect more than 5-10 MB/second.

**Read rate** - the number of MBytes read from the disk per second. You should expect more than 5-10 MB/second.

**Multiply/sec** - the number of floating point multiplies done per second. You should expect more than 50 MFLOPS.

#### 4.6.6 Smooth Scroll

Activates smooth scrolling in the information area of the analysis dialogue box

[Analysis Dialog](#)

Since smooth scrolling limits the rate at which information can be written to the information area, it can considerably slow down the Map3D analysis. It is recommended that smooth scrolling not be used.

## 4.6.7 Cursor Pick Box Size

### 4.6.7.1 Small Pick Box

Defines the desired size of the pick box that is displayed at the cursor cross-hairs.

## 4.7 Shift-key Selection

When checked, the user must hold the shift-key in order to make multiple selections when building a list of entities to edit using any of the CAD > Edit commands. If the shift-key is not held down, the edit command will be automatically executed after the first selection.

When not checked, the edit command will not be automatically executed. Once the list of entities is complete, the user must either:

- pick any of the edit buttons,  execute the highlighted function,
- double click on any vertex to execute the highlighted function,
- or right click for a list of options.

## 4.8 Crosshairs

Toggles drawing of cursor crosshairs.

Crosshairs can be drawn using either OpenGL or Windows API drawing commands (refer to [Tools > OpenGL Crosshairs](#)).

## 4.9 Visualization

### 4.9.1 Visualization (of text files)

This option enables visualization of point data in text file format. Points can be displayed as light source shaded spheres with diameter and/or colour varying as magnitude, and contoured on a plane to display density etc.

Map3D also supports visualization of [EVP formatted files](#).

Each point can be tagged with a series of:

- numeric values (e.g. colour, magnitude, orientation etc.)
- text messages
- file names (e.g. graphics files, documents, spreadsheets etc.)

Upon left clicking on a point, the location, magnitude and text message are displayed on the status bar.

Right clicking on a point activates the [Visual Database](#). This feature can be used to display a database of useful geologic information such as grade, rockmass quality etc.

Each point can be tagged with a series of:

- numeric values (e.g. colour, magnitude, orientation etc.)
- text messages
- file names (e.g. graphics files, documents, spreadsheets etc.)

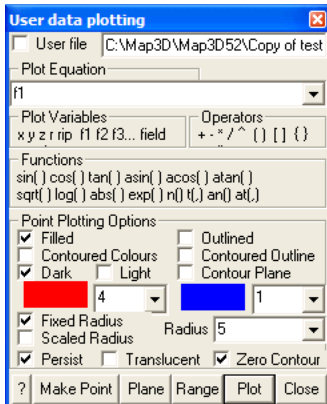

## Event File:

The event file is simply a text file (\*.txt).

This format is useful for exchanging raw model data with other CAD software.

Comment lines must start with an asterisk "\*" in column 1.

Seismic data are stored as a series of points as follows:

$x_1 y_1 z_1 f1 f2 f3 \dots$  "text message" "file name" ...

$x_2 y_2 z_2 f1 f2 f3 \dots$  "text message" "file name" ...

$x_3 y_3 z_3 f1 f2 f3 \dots$  "text message" "file name" ...

...

where  $x_i y_i z_i$  represent the coordinates of each point,

$f1 f2 f3 \dots$  indicates an optional series of numeric values (e.g. colour, magnitude, orientation etc.),

**text message** indicates an optional series of text strings that must be enclosed in double quotes.

**file name** indicates an optional series of file names that must be enclosed in double quotes.

- The text message and file name are displayed in the status bar across the bottom of the screen by picking an event with the left mouse button.
- They can also be edited by picking an event with the right mouse button.
- Picking with the right mouse button also allows for display of the file if the file name has been associated with an application (refer to Windows documentation on how to "Associate a file with a program").

## Merging multiple files into one database

You may select multiple files simultaneously by holding the standard windows "shift" or "ctrl" keys for multiple selections.

These files will be merging into one database.

This allows you to keep separate parts of your visualization data in different files then easily merge them together into one database.

## Plot Equation:

Defines the parameter that will be plotted, e.g.  $(f1-f2)/3$

The pull-down window allows you to store up to 20 different equations. These are stored between Map3D sessions in the map3d.ini file.

### Plot Variables:

**f1 f2 f3...** data fields in the event file.

### Functions:

**sin() cos() tan()** sine, cosine and tangent trigonometric functions

**asin() acos() atan()** Inverse trigonometric functions

**sqrt()** square root function

**log()** natural logarithmic function

**log10()** base 10 logarithmic function

**abs()** absolute value

**exp()** exponential function (antilogarithm)

**n() t(),** normal and t-distribution

**an() at(),** inverse normal and t-distribution

### Location:

**x y z** coordinate of grid point.

### Operators:

**+ - \* / ^** addition, subtraction, multiplication, division and exponentiation operators. Note that exponentials are computed first, followed by multiplication and division and finally addition and subtraction.

**() [] {}** styles of brackets. Pairs of brackets must match.

**>** maximum value. For example if the plot equation is specified as  $f1 > 10$ , the larger of  $f1$  or 10 will be plotted.

**<** minimum value. For example if the plot equation is specified as  $f1 < 10$ , the smaller of  $f1$  or 10 will be plotted.

### Point Plotting Options:

**Filled** – points are filled with the specified colour, contoured colour and/or shaded.

**Contoured Colours** –fill colour is adjusted according to the magnitude determined from the **Plot Equation**.

**Dark** – fill colour is shaded to appear as light source shaded spheres using a dark rich colour scheme.

**Light** – fill colour is shaded to appear as light source shaded spheres using a bright shiny colour scheme.

**Outlined** – points are outlined with the specified colour or contoured colour.

**Contoured Outline** – points are drawn with contour colours adjusted according to the magnitude determined from the **Plot Equation**.

**Contour Plane** – enables or disables display of a contour plane (refer to [Plane](#)).

**Fixed Radius** – points will be plotted as spheres with a the specified **Radius:** parameter.

**Scaled Radius** – points will be plotted as spheres with radius scaled to the magnitude (determined from the **Plot Equation**) such that if the magnitude is less than the minimum of the contour range, the sphere is drawn with zero radius. If the magnitude equals the maximum of the contour range, the vector is drawn with the radius specified by the **Radius:** parameter.

### Other:

**Persist** – when checked, the points will be re-plotted each time the model is reoriented, translated or zoomed. Since this may be time consuming for large models this option may not always be desired.

**Translucent** - draws the points as translucent spheres.

**Zero Contour** - when unchecked, contours below the minimum contour range are not drawn. This is useful for displaying contours where only the upper part of the contour range is important.

**Make Point** - adds of a new point.

**Plane** – enables setup of the contour plane.

**Range** – specify the minimum, maximum and interval for radius scaling and contouring.

 **Plot** regenerates the plot. This button can be placed on either the View Toolbar ([Tools > View Toolbar Configure](#)) or the Contour Toolbar ([Tools > Contour Toolbar Configure](#)).

## 4.9.2 Visualization (of EVP files)

This option enables visualization of point data in EVP file format (from IMS seismic systems). Points can be displayed as light source shaded spheres with diameter and/or colour varying as magnitude, and contoured on a plane to display density etc.

Map3D also supports visualization of [text formatted files](#).

Each point can be tagged with a series of:

- numeric values (e.g. colour, magnitude, orientation etc.)
- text messages
- file names (e.g. graphics files, documents, spreadsheets etc.)

Upon left clicking on a point, the location, magnitude and text message are displayed on the status bar.

Right clicking on a point activates the [Visual Database](#). This feature can be used to display a database of useful geologic information such as grade, rockmass quality etc.

Each point can be tagged with a series of:

- numeric values (e.g. colour, magnitude, orientation etc.)
- text messages
- file names (e.g. graphics files, documents, spreadsheets etc.)

EVP file plotting ✕

User file C:\Map3D\Map3D61\Hofmann\test.e

Magnitude Equation  
 Local Magnitude  Moment Magnitude  
 0.516\*log10(M) + 0.344\*log10(E) - 6.572

Plot Variables: x y z r rip E M      Operators: + - \* / ^ ( ) [ ] { } > < "

Functions:  
 sin( ) cos( ) tan( ) asin( ) acos( ) atan( ) sqrt( )  
 log( ) log10( ) abs( ) exp( ) n( ) t( ) an( ) at( )

Filters

Start Time R 2015/03/16 19:20:02

End Time R 2015/10/03 06:34:30

Mag Min/Max R -1 1

Trig Min/Max R 0 20

Polygon file

Offset Z-/Z+ R -1000 1000

Point Plotting Options

Filled  Outlined

Contoured Colours  Contoured Outline

Dark  Light  Points Off

4  1

Fixed Radius  Persist

Mag Scaled Radius  Translucent

Radius Min/Max: 0 5

Mag Scale Min/Max: -1 1

Contour Time  Min Contour

Contour Magnitude  Max Contour

? Make Pnt Plane Mag Range Plot Close

### Event File:

The event file is in \*.EVP file format.

EVP event files are produced by IMS seismic systems.

Seismic data are stored as a series of points as follows:

```
date time le x1 y1 z1 M E Mp Ep Ms Es trigs... "text message" "file name" ...
date time le x2 y2 z2 M E Mp Ep Ms Es trigs... "text message" "file name" ...
date time le x3 y3 z3 M E Mp Ep Ms Es trigs... "text message" "file name" ...
```

...

where  $x_i, y_i, z_i$  represent the coordinates of each point,

**M** represents the seismic moment,

**E** represents the energy radiated,

**trigs** represents the number of triggers,

**text message** indicates an optional series of text strings that must be enclosed in double quotes.

**file name** indicates an optional series of file names that must be enclosed in double quotes.

- The text message and file name are displayed in the status bar across the bottom of the screen by picking an event with the left mouse button.
- They can also be edited by picking an event with the right mouse button.
- Picking with the right mouse button also allows for display of the file if the file name has been associated with an application (refer to Windows documentation on how to "Associate a file with a program").

## Merging multiple files into one database

You may select multiple files simultaneously by holding the standard windows "shift" or "ctrl" keys for multiple selections.

These files will be merging into one database.

This allows you to keep separate parts of your visualization data in different files then easily merge them together into one database.

## Magnitude Equation:

Defines the parameter that will be plotted, e.g.  $(0.516 \cdot \log_{10}(M) + 0.344 \cdot \log_{10}(E) - 6.572)$

The pull-down window allows you to store up to 20 different equations. These are stored between Map3D sessions in the map3d.ini file.

## Plot Variables:

**E M** data fields in the event file.

## Functions:

**sin() cos() tan()** sine, cosine and tangent trigonometric functions

**asin() acos() atan()** Inverse trigonometric functions

**sqrt()** square root function

**log()** natural logarithmic function

**log10()** base 10 logarithmic function

**abs()** absolute value

**exp()** exponential function (antilogarithm)

**n() t(),** normal and t-distribution

**an() at(),** inverse normal and t-distribution

## Location:

**x y z** coordinate of grid point.

## Operators:

**+ - \* / ^** addition, subtraction, multiplication, division and exponentiation operators. Note that exponentials are computed first, followed by multiplication and division and finally addition and subtraction.

**() [] {}** styles of brackets. Pairs of brackets must match.

- > maximum value. For example if the plot equation is specified as  $f1 > 10$ , the larger of  $f1$  or 10 will be plotted.
- < minimum value. For example if the plot equation is specified as  $f1 < 10$ , the smaller of  $f1$  or 10 will be plotted.

### Filters:

**Start/End Time** – the lower and upper limits of the date/time filter.

**Mag Min/Max** – the lower and upper limits of the magnitude filter.

**Trig Min/Max** – the lower and upper limits of the # triggers filter.

**Polygon File** – the name of the file containing the polygon filter. This file must be in [\\*.pnt file format](#). To assist in creating this file the [Plane](#) function allows you to set the [UDCS](#) (user defined coordinate system) to the best fit plane.

**Offset Z-/Z+** – the lower and upper limits of the Z-offset from the Polygon filter.

### Point Plotting Options:

**Filled** – points are filled with the specified colour, contoured colour and/or shaded.

**Contoured Colours** –fill colour is adjusted according to the magnitude determined from the **Plot Equation**.

**Dark** – fill colour is shaded to appear as light source shaded spheres using a dark rich colour scheme.

**Light** – fill colour is shaded to appear as light source shaded spheres using a bright shiny colour scheme.

**Outlined** – points are outlined with the specified colour or contoured colour.

**Contoured Outline** – points are drawn with contour colours adjusted according to the magnitude determined from the **Plot Equation**.

**Contour Plane** – enables or disables display of a contour plane (refer to [Plane](#)).

**Fixed Radius** – points will be plotted as spheres with a the specified **Radius:** parameter.

**Magnitude Scaled Radius** – points will be plotted as spheres with radius scaled to the magnitude (determined from the **Magnitude Equation**) such that if the magnitude is less than the minimum of the contour range, the sphere is drawn with Min radius specified by the **Radius:** parameter.. If the magnitude exceeds the maximum of the contour range, the vector is drawn with the Max radius specified by the **Radius:** parameter.

### Other:

**Persist** – when checked, the points will be re-plotted each time the model is reoriented, translated or zoomed. Since this may be time consuming for large models this option may not always be desired.

**Translucent** - draws the points as translucent spheres.

**Min Contour** - when unchecked, contours below the minimum contour range are not drawn. This is useful for displaying contours where only the upper part of the contour range is important.

**Max Contour** - when unchecked, contours above the maximum contour range are not drawn. This is useful for displaying contours where only the lowerer part of the contour range is important.

**Make Point** - adds of a new point.

**Plane** – enables setup of the contour plane.

**Range** – specify the minimum, maximum and interval for radius scaling and contouring.

 **Plot** regenerates the plot. This button can be placed on either the View Toolbar ([Tools > View Toolbar Configure](#)) or the Contour Toolbar ([Tools > Contour Toolbar Configure](#)).



### 4.9.3 Visualization Database

This feature can be used to display a database of useful geologic information such as grade, rockmass quality etc.

Each point can be tagged with a series of:

- numeric values (e.g. colour, magnitude, orientation etc.)
- keywords
- text messages
- file names (e.g. graphics files, documents, spreadsheets etc.)

To activate this feature you right-click on a visualization data point (see [Visualization](#)).

If there are no visualization points one can be created using [Make Point](#) - adds of a new point.

Upon right-clicking you will be presented with a popup menu with the following options:

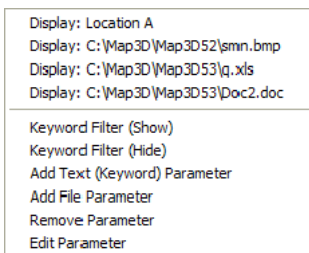

The "Display" items in the upper section of this menu are data that are attached to the data point (respectively, a text string, bitmap, spreadsheet and document). Selecting of these will display that item.

The items in the lower section of this menu are functions that access the database:

**Keyword Filter (Show)** – used to specify a series of show keyword filters. Only point data that has one of these keywords associated with it will be visible, all others will be hidden. This allows users to filter display of desired database entries.

**Keyword Filter (Hide)** – used to specify a series of hide keyword filters. Point data that has one of these keywords associated with it will be hidden, all others will be visible. This allows users to filter display of unwanted database entries.

**Add Text (Keyword) Parameter** - used to add a text string to a data point. This text is used for keyword filtering. This text will be added to the display list.

**Add File Parameter** - used to add a file parameter to a data point. The file name is used for keyword filtering. This file will be added to the display list. Any file name can be specified here (e.g. graphics files, spreadsheet files, document files etc.) If the file type is associated with an application, that application will be automatically started in order to display the specified file.

**Remove Parameter** - used to remove a parameter from the data point.

**Edit Parameter** - used to edit or modify a parameter.

#### 4.9.4 Contour Plane Options

Enables setup of the plane used for contouring of visualization point data (see [Visualization](#)).

Contour plane definition	
X-centre	-742.846680
Y-centre	1785.066650
Z-centre	-1280.336670
Dip of plane	79.470
Dip direction	180
Plunge of norm	-10.530000
Copy from Grid# -->	1
Linear regression	rms 0.000001
Make grid	Cv 0.000%
Make Map3Di file	Pick Normal
Plotting Options	
<input checked="" type="radio"/> Num in voxel	<input type="radio"/> Sum in voxel
<input type="radio"/> Sum in voxel/Num in voxel	
Grid Spacing	10 <input type="checkbox"/> Grid Lines
Max Width	366.85 <input type="checkbox"/> Voxel Line
Voxel width	10
Voxel height	10
<input checked="" type="checkbox"/> Persist	<input type="checkbox"/> Transluc <input checked="" type="checkbox"/> Zero Cor
? Range Plot Close	

**X-centre** – the x-coordinate value of the centre of the contour plane.

**Y-centre** – the y-coordinate value of the centre of the contour plane.

**Z-centre** – the z-coordinate value of the centre of the contour plane.

**Dip of plane** – the dip of the contour plane.

**Dip direction** – the dip direction of the contour plane.

**Dip of normal** – the dip of the normal to the contour plane (this value is 90° from the dip of the plane).

**Pick Normal** - activates the cursor allowing interactive selection of a surface. The centre, dip and dip direction of the contour plane will be set parallel to the selected surface.

**Copy from Grid#** – copies the location and orientation parameters from a model grid plane.

**Linear regression** – finds a best fit plane through the seismic data by minimizing the normal distance from all points to the plane.

**Make Grid** – creates a model grid plane from the contour plane.

**Make Map3Di file** – generates a data file from the contoured data to be used for seismic loading in a [Map3Di](#) analysis (more on this below).

##### Contour Plane Options:

**Num in voxel** – the count of the number of points within each voxel is contoured.

**Sum in voxel** – the sum of the plot equation values for all points located in the voxel is contoured.

**Sum/Num in voxel** – the quotient of the two values is contoured.

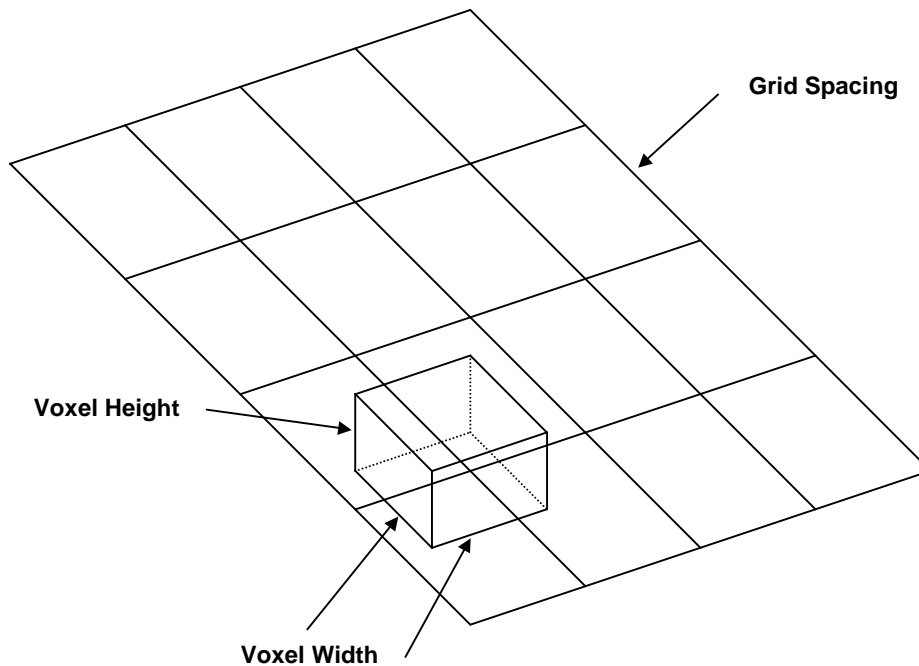

**Grid spacing** – the grid spacing used to contour the seismic data. Since the voxel is centred at each grid corner, this parameter controls the density of the voxels. Note that if the grid spacing is smaller than the voxel width, adjacent voxels will overlap.

**Voxel width** – the voxel width is measured parallel to the edges of the grid plane.

**Voxel height** – the voxel height is measured perpendicular to the grid plane. This allows the user to limit the distance from the grid plane within which data will be included in the contouring.

**Outlines** – draws the actual voxel outlines.

**Persist** – when checked, the points will be re-plotted each time the model is reoriented, translated or zoomed. Since this may be time consuming for large models this option may not always be desired.

**Translucent** - draws the points as translucent spheres.

**Zero Contour** - when unchecked, contours below the minimum contour range are not drawn. This is useful for displaying contours where only the upper part of the contour range is important.

**Range** – specifies the minimum, maximum and interval for radius scaling and contouring.

 **Plot** regenerates the plot. This button can be placed on either the View Toolbar ([Tools > View Toolbar Configure](#)) or the Contour Toolbar ([Tools > Contour Toolbar Configure](#)).

### Linear Regression:

The linear regression is conducted by finding the plane that has the minimum *rms* value (the root mean square, or mean distance of all points to the fitted plane).

Standard theory on correlation coefficient is not suitable as a measure of goodness of fit in this case. This is because we are not interested in the "measure of the degree of association between variables" but rather we want a measure of how well the fitted plane represents our data. Note that if all data lies in a single horizontal plane, we have a perfect plane fit. By definition however there is zero correlation (and hence the correlation coefficient equals zero) because the z value does not depend on the x or y values. This is not what we want.

Here a parameter similar to a coefficient of variation (a measure of the variability divided by the magnitude) is defined.  $C_v$  is simply defined as the **rms** value (the mean distance of all points to the fitted plane) divided by the mean distance of all points to the centroid. This measures how well the plane represents the data. This ratio is usually expressed as a percentage. Defined like this, random data gives a  $C_v=100\%$  (100% variability). A perfect fit gives a  $C_v=0$  (0% variability). Note that it is possible for  $C_v$  to exceed 100%. You can think of this parameter as the ratio of the variability around the plane divided by the physical width of the data set.

This is very similar to the formal definition of coefficient of variation which is standard deviation divided by the mean. Most geologic materials have properties with  $C_v$  on the order of 20 to 30%.  $C_v$  could be turned into an equivalent correlation coefficient using

$$r = (1 - C_v^2)^{1/2}$$

but this is not really the correct parameter to use and there are problems in definition for cases where  $C_v$  exceeds 1.

Both the **rms** and  $C_v$  are displayed for the current plane whenever data is plotted.

#### Make Map3Di file:

In order to make a Map3Di loading file one must determine the shear displacement distribution (ride) indicated by the seismicity. This requires several assumptions (refer to A. McGarr, "Some Applications of Seismic Source Mechanism Studies to Assessing Underground Hazard", Proc. 1st International Symposium on Rockbursts and Seismicity in Mines, SAIMM, Johannesburg, 1984, pp. 199-208, and Hoffman, G. R. Sewjee and G. van Aswegan, "First steps in the integration of numerical modelling and seismic monitoring", 5th International Symposium on Rockburst and Seismicity in Mines, SAIMM, Johannesburg, 2000, pp. 397-404.) which are outlined here:

- 1) Assuming a slip model. Here we can consider either an elliptic crack model (Brune) or an asperity model with soft edges due to creep (Walsh, J.J. and J. Waterson, "Distribution of cumulative displacements and seismic slip on a single normal fault surface", J. Struct. Geol., V. 9, 1987, pp. 1039-1046). Generally a circular (penny) shape will be used unless the user has some way to define an alternate shape.
- 2) The average value of slip can be determined from the seismic moment  $M_o = \mu AD$  where  $\mu$  is the modulus of rigidity,  $A$  is the source area (determined from the source radius), and  $D$  is the average slip across the fault. This can also be determined from the determined from the "Seismic Strain Drop".
- 3) The slip surface radius can be estimated from the Brune radius as  $a = 2.34 \beta / (2\pi f_o)$ , where  $\beta$  is the shear wave velocity and  $f_o$  is the corner frequency. For an asperity model, the radius determined from the radius of the "Apparent Volume" is probably more appropriate.
- 4) The orientation of slip can be determined from the seismic moment tensor if available, or from the stress state from modelling.

From these 4 items you can determine the slip profile indicated by the seismic event.

For an elliptic profile, the shear displacement (ride) distribution is given by

$$1.50 D(1-r^2/a^2)^{1/2}$$

For an asperity profile, the shear displacement (ride) distribution is given by

$$2.89 D(1-rl/a)(1+2rl/a-3r^2/a^2)^{1/2}$$

A seismic loading file can be generated for Map3Di as follows:

1) Construct a seismic data file with as a series of points:

```
x1 y1 z1 f1 f2 ...  
x2 y2 z2 f1 f2 ...  
x3 y3 z3 f1 f2 ...  
...
```

where  $x_i, y_i, z_i$  represent the coordinates of each point,

**f1** indicates the average slip  $D$ , and **f2** indicates the source radius  $a$ .

2) Using the Visualization routine, for an elliptic profile specify the plot equation as

$$1.50*f1*\sqrt{1-rip^2/f2^2}$$

For an asperity profile use

$$2.89*f1*(1-rip/f2)*\sqrt{1+2*rip/f2-3*rip^2/f2^2}$$

3) Choose your desired plane, grid spacing, set the desired voxel height and width. The voxel height can be used to clip out of plane events. It is important to choose the voxel width equal to the largest desired event radius in order to distribute the shear displacement (ride) over all affected voxels.

4) Set Plotting Options to "Sum in Voxel" and Plot.

5) Make Map3Di file.

6) View Map3Di file using CAD > Properties > Map3Di Setup and view the f2 parameter.

Refer to [CAD > Properties > Map3Di](#) for details concerning the data format.

## 4.9.5 Plot

Plots seismic data. Points can be displayed as light source shaded spheres with diameter and/or colour varying as magnitude (see [Visualization](#)).

This button can be placed on the view toolbar or the contouring toolbar using

 [Tools > Configure View Toolbar](#)

 [Tools > Configure Contouring Toolbar](#)

## 4.10 Help

### 4.10.1 Contents and Index

Opens the help contents and index.

### 4.10.2 What's This?

Activates context sensitive help.

Once activated, a question mark cursor appears. You can then use this to pick any menu item or toolbar button to obtain help.

This has the same effect as simply right clicking on an item.

#### 4.10.3 Web: [www.map3d.com](http://www.map3d.com)

Opens [www.map3d.com](http://www.map3d.com) in the default web browser.

#### 4.10.4 Email: [support@map3d.com](mailto:support@map3d.com)

Emails [support@map3d.com](mailto:support@map3d.com) using the default emailer.

#### 4.10.5 Email: Key check to [support@map3d.com](mailto:support@map3d.com)

Emails "Key Check" results to [support@map3d.com](mailto:support@map3d.com) using the default emailer.

These results are required for debugging installation problems and determining lease expiry dates etc.

#### 4.10.6 Download: Map3D update (setup.exe)

Command: Map3D update (setup.exe)

Downloads the latest Map3D update from the Map3D website [www.map3d.com/update.htm](http://www.map3d.com/update.htm)

The complete update includes all Map3D executables, automated installation routines, the Map3D User's Manual in HTML format, and Sentinel SuperPro key drivers as well as a few sample files.

As the complete update (setup.exe) is quite large (8MB), an alternative is to download the updated executables only (Map3D.zip).

Command: Map3D update (Map3D.zip) This does not include the installation routines, the Map3D User's Manual in HTML format, nor the Sentinel SuperPro key drivers. Note that the HTML Map3D User's Manual (Map3D.chm) is required for context sensitive help to function from within Map3D.

The user's manual can be downloaded in several formats:

Command: Map3D HTML User's Manual (Map3D.chm) The HTML User's Manual can be download from [Tools > Download HTML User's Manual](#). This manual is in native Windows HTML help format.

Command: Map3D PDF User's Manual (Map3D\_Help.pdf) The PDF User's Manual can be download from [Tools > Download PDF User's Manual](#). This manual is in PDF format as is a good choice for printing.

Command: Map3D Ebook User's Manual (Map3D\_Help.ebook) The Electronic book User's Manual can be download from [Tools > Download Ebook User's Manual](#). This manual is in a standalone electronic book format.

#### 4.10.7 Download: Map3D update (Map3D.zip)

Command: Map3D update (Map3D.zip)

Downloads the latest Map3D update from the Map3D website [www.map3d.com/update.htm](http://www.map3d.com/update.htm)

This does not include the installation routines, the Map3D User's Manual in HTML format, nor the Sentinel SuperPro key drivers. Note that the HTML Map3D User's Manual (Map3D.chm) is required for context sensitive help to function from within Map3D.

**oad: Map3D update (setup.exe)** The complete update includes all Map3D executables, automated installation routines, the Map3D User's Manual in HTML format, and Sentinel SuperPro key drivers as well as a few sample files.

The user's manual can be downloaded in several formats:

**ad HTML User's Manual (Map3D.chm)** The HTML User's Manual can be download from [Tools > Download HTML User's Manual](#). This manual is in native Windows HTML help format.

**d PDF User's Manual (Map3D\_Help.pdf)** The PDF User's Manual can be download from [Tools > Download PDF User's Manual](#). This manual is in PDF format as is a good choice for printing.

**d Ebook User's Manual (Map3D\_Help.ebook)** The Electronic book User's Manual can be download from [Tools > Download Ebook User's Manual](#). This manual is in a standalone electronic book format.

#### 4.10.8 Download: HTML User's Manual

**ad HTML User's Manual (Map3D.chm)** The HTML User's Manual can be download from [Tools > Download HTML User's Manual](#). This manual is in native Windows HTML help format.

**d PDF User's Manual (Map3D\_Help.pdf)** The PDF User's Manual can be download from [Tools > Download PDF User's Manual](#). This manual is in PDF format as is a good choice for printing.

**d Ebook User's Manual (Map3D\_Help.ebook)** The Electronic book User's Manual can be download from [Tools > Download Ebook User's Manual](#). This manual is in a standalone electronic book format.

#### 4.10.9 Download: PDF User's Manual

**ad HTML User's Manual (Map3D.chm)** The HTML User's Manual can be download from [Tools > Download HTML User's Manual](#). This manual is in native Windows HTML help format.

**d PDF User's Manual (Map3D\_Help.pdf)** The PDF User's Manual can be download from [Tools > Download PDF User's Manual](#). This manual is in PDF format as is a good choice for printing.

**d Ebook User's Manual (Map3D\_Help.ebook)** The Electronic book User's Manual can be download from [Tools > Download Ebook User's Manual](#). This manual is in a standalone electronic book format.

#### 4.10.10 Download Ebook User's Manual

**ad HTML User's Manual (Map3D.chm)** The HTML User's Manual can be download from [Tools > Download HTML User's Manual](#). This manual is in native Windows HTML help format.

**d PDF User's Manual (Map3D\_Help.pdf)** The PDF User's Manual can be download from [Tools > Download PDF User's Manual](#). This manual is in PDF format as is a good choice for printing.

**d Ebook User's Manual (Map3D\_Help.ebook)** The Electronic book User's Manual can be download from [Tools > Download Ebook User's Manual](#). This manual is in a standalone electronic book format.

#### 4.10.11 About Map3D

Version and license information.



**Map3D  
User's Manual**

**Part**



## 5 Appendix

### 5.1 Analysis

#### 5.1.1 Analysis > Options > MSCALC Output File Name

Displays the file name containing user defined points

[Analysis > Options > MSCALC](#).

#### 5.1.2 Analysis > Abort

Aborts execution of the analysis.

Related Topics:

[Analysis > Suspend](#)

#### 5.1.3 Analysis > Auto Plot

Activates the auto plot feature.

When checked Map3D automatically plots the selected surface components as the Map3D BEM analysis proceeds. Any desired surface component can be plotted. By default the surface stress error is plotted

 [Plot > Surface Components > Serr](#) Stress Error.

To change the surface component that is plotted:

1. During analysis select [Analysis > Suspend](#)
2. Select the desired component from the solve toolbar [Tools > Solve Toolbar](#)
3. To continue the analysis, select [Analysis > Resume](#)

Notes

You must check [Tools > Solve Toolbar](#) for the solve toolbar to be displayed when you suspend the analysis.

To have Map3D automatically modify the contour range as the Map3D BEM analysis proceeds, check [Analysis > Auto Range](#)

#### 5.1.4 Analysis > Auto Range

Activates the auto range feature.

When checked Map3D automatically modifies the contour range as the Map3D BEM analysis proceeds.

To automatically plot surface components, you must activate

[Analysis > Auto Plot](#)

### 5.1.5 Analysis > BEM Analysis

Starts the Map3D BEM analysis.

Options:

[Analysis > Options > VRAM](#)

[Analysis > Options > PRAM](#)

[Analysis > Options > Drive 1](#)

[Analysis > Options > Drive 2](#)

[Analysis > Options > Drive 3](#)

[Analysis > Options > Drive 4](#)

[Analysis > Options > Creep](#)

[Analysis > Options > Move Points](#)

[Analysis > Options > Verbose](#)

[Analysis > Options > CGM](#)

[Analysis > Options > Accelerator](#)

[Analysis > Options > Async I/O](#)

[Analysis > Options > Linear](#)

[Analysis > Options > Zero Strain Support Placement](#)

[Analysis > Options > Initialization](#)

Related Topics:

[Analysis Dialog](#)

[Analysis > Suspend](#)

[Analysis > ABORT](#)

### 5.1.6 Analysis > Discretization

Discretization the model.

All excavation surfaces are automatically discretized by concentrating elements where results are requested

 [View > Render > Discretize](#)

Analysis results are calculated on DD surfaces and on a series of user defined grid planes

 [CAD > Build > Grid Plane](#)

or at user defined points

[Analysis > Options > MSCALC](#)

The grid planes are automatically discretized into a series of field points at which displacements, strains and stresses are calculated.

The discretization analysis can be repeated as many times as desired with different control parameters.

The user has complete control over the way in which the model is discretized by specifying various control parameters (Element Length [AL](#), Grid Spacing [AG](#), Element Discretization [DON](#), Grid Discretization [DOL](#))

[Analysis > CParams](#)

and by specifying the maximum element width for 3D FF blocks and DD planes

 [CAD > Edit > Entities > Maximum Element Width](#)

as well as for field point grids

 [CAD > Edit > Entities > Maximum Element Width](#)

Refer to [Discretization and Lumping](#) for a thorough discussion on how to set up these control parameters.

Options:

[Analysis > Options > MSCALC](#)

[Analysis > Options > LERD/LSS](#)

[Analysis > Options > Lumping](#)

Related Topics:

[Analysis Dialog](#)

[Analysis > Suspend](#)

[Analysis > ABORT](#)

[Analysis > Restart](#)

### 5.1.7 Analysis > Go to CAD

If you are viewing results, then "Go to CAD" returns you to the CAD Model stage.

If you are at the CAD Model stage, then "Go to Results" returns you to the viewing results stage.

Related Topics:

[Analysis > Graphics](#)

### 5.1.9 Analysis > View Results

Closes the Analysis dialogue box and returns to the graphics display at the current analysis stage.

Related Topics:

[Analysis > Go to CAD](#)

[Analysis > Go to Results](#)

### 5.1.10 Analysis > Intersections

Conducts contact and intersection analysis.

One of the keys to ease of use in Map3D is model construction using solid modelling technology. This permits users to build models using a series of three-dimensional building blocks and DD planes. These entities, which can be any desired shape, size and orientation, are used to construct excavations and accesses as well as to define non-homogeneous zones (e.g. ore zones, dykes and yielding zones). The program automatically builds intersections between excavations, faults and multiple material zones. By coupling this capability with the built-in Boolean operations, complex multi-step mining sequences can be constructed with ease.

Options:

[Analysis > Options > Collapse](#)

[Analysis > Options > Planarity](#)

[Analysis > Options > Closure](#)

Related Topics:

[Analysis Dialog](#)

[Analysis > Suspend](#)

[Analysis > ABORT](#)

### 5.1.11 Analysis > Load Model

Loads a model from a file ([INP](#) or [DXF](#) format). Once loaded the user can use

[Analysis > Go to CAD](#)

to add or edit mining blocks and set up the Map3D analysis.

While loading the model Map3D checks for basic consistency of the modelling parameters (e.g. if a material is used, its properties must be specified in the material list).

Options:

[Analysis > Options > Reunmber](#)

[Analysis > Options > Collinearity](#)

Related Topics:

[Analysis Dialog](#)

[Analysis > Suspend](#)

[Analysis > ABORT](#)

### 5.1.12 Analysis > Minimize

Minimizes the graphics display during analysis.

The analysis dialogue box can be minimized by selecting the minimize button from the windows system menu at the top right of the dialogue box.

### 5.1.13 Analysis > Options > Accelerator

Use the matrix accelerator – during Map3D BEM analysis.

This solver will accelerate convergence even for poorly conditioned problems and can reduce the total number of iterations by half or more. This option can be used in conjunction with the CGM option ([Analysis > Options > CGM](#)) to provide a reduction in the total number of iterations by a quarter or more.

Notes:

This function must be checked before conducting the Map3D BEM analysis

[Analysis > BEM Analysis](#)

It is recommended that this option be used.

### 5.1.14 Analysis > Options > Async I/O

Use Windows asynchronous I/O routines – during Map3D BEM analysis.

Windows allows disk I/O to be conducted asynchronously from the BEM analysis. This is supposed to allow disk I/O to occur in parallel with other calculations thus reducing matrix solution time.

Notes:

This function must be checked before conducting the Map3D BEM analysis

[Analysis > BEM Analysis](#)

### 5.1.15 Analysis > Options > Auto Repair

Attempts to repair you model by filling gaps, deleting duplicates etc.- during file load.

Model pre-processing to detect common model building errors including:

- detection and automatic filling of simple gaps such as missing surfaces - highlighted in **black**.
- detection and automatic deletion of duplicate blocks - highlighted in **green**.
- detection of narrow gaps between adjacent blocks - highlighted in **blue**. The warning is generated when ever the gap is less than 1/1000 of the element width.
- detection of edges that link the wrong way to other edges - highlighted in **white**.
- detection of edges that do not link to any other edges - highlighted in **red**.
- detection of edges that link to too many other edges - highlighted in **yellow**.

The above model problems will not necessarily stop Map3D from running properly, but close scrutiny of these locations will help user's debug problems and find unintended construction errors.

### 5.1.16 Analysis > Options > Batch

Set up analysis batch queue.

If the user has multiple models that need to be run, these can be specified in this batch queue. By selecting

[Analysis > Options > Batch > Execute Batch Queue](#)

all checked models will be run without any request for interactive response from the user.

When you check a batch file for execution you will be prompted to search for a model file name, location, and [file format](#). If the search is successful, the model will be checked.

The second column in the Batch File Setup dialogue box allows you to set analysis options if desired. These settings override any options set in the [Analysis > Options](#) dialogue box.

#### Console Mode:

Map3D can be started from the Windows command prompt or from a \*.bat file if desired. Command line options can be used in a text file script or entered from a Command Prompt. The procedure is simply to create a \*.bat file as follows:

**Map3D filename.inp -option1 -option2 ...** (where "filename.inp" is the name of the model file you want to analyse).

The options are as follows:

- console** (displays only the "Analysis Dialog" while Map3D is running).
- stop** (stops Map3D upon completion of analysis).
- silent** (displays nothing at all while Map3D is running and stops upon completion of analysis).

You can also open results files as follows:

**Map3D filename.001** (where "filename.001" is the name of the results file you want to display).

#### Notes:

Batch model file names are saved and restored each time Map3D is executed.

Model files that are not checked will not be executed in batch mode.

The batch queue can be interrupted at any time simply by aborting the current analysis

[Analysis > Abort](#)

### 5.1.17 Analysis > Options > CGM

Use the conjugate gradient solver – during Map3D BEM analysis.

This solver will accelerate convergence even for poorly conditioned problems and can reduce the total number of iterations by half or more. This option can be used in conjunction with the matrix accelerator ([Analysis > Options > Accelerator](#)) to provide a reduction in the total number of iterations by a quarter or more.

Notes:

This function must be checked before conducting the Map3D BEM analysis

[Analysis > BEM Analysis](#)

It is recommended that this option be used.

### 5.1.18 Analysis > Options > Closure

Conducts closure and overlap checking, and resolves Boolean intersections – during intersection analysis.

Complex excavation shapes are checked to ensure that their bounding surfaces form a continuous envelope with no gaps or missing surfaces. Locations where a gap is detected are identified by coordinate numbers in that vicinity.

Interference between intersecting features such as a fault and an ore zone are automatically resolved by Map3D. Surfaces are subdivided to create edges where these features meet. A solid modelling Boolean operation is then performed to determine which feature persists through the other. Since it is not clear whether the fault should persist through the ore, or the ore should persist through the fault, a convention has been adopted in Map3D such that the feature with the higher material number takes priority over a feature with a lower material number. For example if the ore were assigned material number 2 and the fault were assigned material number 3, the fault would be assumed to be continuous through the ore. Note that excavations are assumed to cut through all other features.

For additional discussion, refer to

[Constructing Alternate Material Zones.](#)

Notes

This function must be checked before conducting the intersection analysis

[Analysis > Intersections.](#)

It is recommended that you check this option.

### 5.1.19 Analysis > Options > Collinearity

Merge coordinate points that are close to one another – during file load.

Coordinate points that are very close to one another are merged together. Coordinate points that are very near an edge of a surface are moved onto that edge. By default Map3D will move these points if they are within a search radius of 1000th of the edge length from the surface.

If desired, the user can define a search radius by entering a value in the data box. Other CAD packages may not link corners of surfaces together. This feature is useful for eliminating small gaps and overlaps between adjacent surfaces and blocks. Extreme caution should be used when specifying a non-zero value for this parameter since large values can cause more problems than it will fix by merging too many points together.

Notes

This function must be checked before loading the model file

[Analysis > Load Model.](#)

It is recommended that you check this option. However caution must be exercised if a non-zero search radius is specified since too large a value can cause undesired merging of coordinate points thus destroying model integrity.



### 5.1.20 Analysis > Options > Collinearity Search Radius

Specifies the search radius that is used in collinearity checking during file load (see [Analysis > Options > Collinearity](#)).

Coordinate points that are very close to one another are merged together. Coordinate points that are very near an edge of a surface are moved onto that edge. By default Map3D will move these points if they are within a search radius of 1000th of the edge length from the surface.

If desired, the user can use this option to define a search radius by entering a value in the data box. Other CAD packages may not link corners of surfaces together. This feature is useful for eliminating small gaps and overlaps between adjacent surfaces and blocks.

#### Notes

This function must be checked before loading the model file

[Analysis > Load Model](#).

Caution must be exercised if a non-zero search radius is specified since too large a value can cause undesired merging of coordinate points thus destroying model integrity.

### 5.1.21 Analysis > Options > Collapse

Merge adjacent surfaces – during intersection analysis.

Surfaces that share common edges and can be collapsed into a single quadrilateral, will be, provided they are parallel to one another.

#### Notes

This function must be checked before conducting the intersection analysis

[Analysis > Intersections](#).

This can result in a large reduction in problem size significantly reducing analysis time.

It is recommended that you check this option unless you specifically do not want adjacent surfaces to be merged.

### 5.1.22 Analysis > Options > Creep

Conduct elasto-visco-plastic creep analysis.

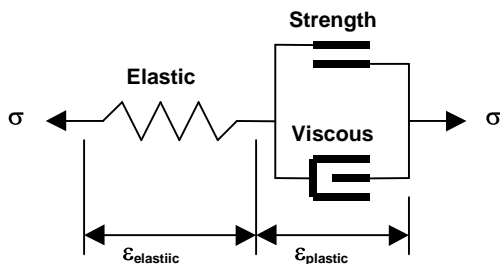

This feature is used only in non-linear analyses (3D FF blocks in Map3D Non-Linear and DD planes in Map3D Fault-Slip). The creep model can be used simply as a technique for damping the non-linear

deformations or if this creep option is activated, for real time dependant creep simulation.

At each creep step the stress state on all yielding elements (elements where the stress exceeds the strength) is calculated as the strength plus the creep resistance. This limits the size of plastic creep increment  $\Delta\epsilon_{\text{plastic}}$  on each yielding element

$$\sigma = \text{Strength} + C \Delta\epsilon_{\text{plastic}} / \Delta t$$

$$C = G \Delta t$$

where the creep resistance is determined as the creep coefficient  $C$ , times the plastic strain rate  $\Delta\epsilon_{\text{plastic}} / \Delta t$ . Note that the user must select both the creep coefficient  $C$ , and the time step size  $\Delta t$ , then specify the quotient of these as the viscous modulus  $G$ . The contribution to the stress  $\sigma$ , made by the creep increment is the excess stress given by

$$\Delta\sigma = C \Delta\epsilon_{\text{plastic}} / \Delta t$$

The maximum excess stress for all yielding elements is indicated by  [Plot > Surface Components > Ferr](#)

If this creep option is activated, Map3D will execute only one creep increment for each mining step. Thus the elapsed time can be determined as the product of the current time step number  $is$  ([Analysis Dialog](#)) with the user defined time step size  $\Delta t$ .

$$\text{Total Elapsed Time} = is \Delta t$$

The user may wish to repeat several mining steps without adding any new mining simply to allow the model to creep for a controlled number of steps.

If this creep option is not activated, Map3D will execute as many creep increments as is required to reduce  $fer$  below the stress tolerance  $STOL$ , before moving onto the next mining step.

In either case, the accumulated plastic strain  $\epsilon_{\text{plastic}}$ , is determined as the sum of the plastic creep increments  $\Delta\epsilon_{\text{plastic}}$ , for all creep steps.

Related Topics:

 [Plot > Surface Components > DTs](#) Excess Shear Stress

 [Plot > Surface Components > DEs](#) Incremental Shear Strain

 [Plot > Surface Components > Ts](#) Shear Stress

 [Plot > Surface Components > Es](#) Shear Strain

This function must be checked before conducting the Map3D BEM analysis

[Analysis > BEM Analysis](#)

### 5.1.23 Analysis > Options > #C/T

Displays the number of cores/threads active.

Map3D fully supports parallel processing and parallel disk I/O with the multi-processor/multi-drive option.

If you are licensed to use the multi-processor/multi-drive option, Map3D will conduct all analysis procedures in parallel distributed among all available processors.

**CPU:** Recent CPU's are now available as dual, quad and hex cores.

Map3D V58 now supports parallel processing which allows faster computational rates. This results in more than 6x reduction in matrix assembly and grid assembly times. Multi-CPU computers would go even faster.

The following parallel processing benchmark clearly shows that you can expect dual cores CPU's to perform more than twice as fast, quad cores to perform more than 4 times as fast and hex-cores to perform more than 6 times faster. In hyper-threading enabled CPUs, 2 computational threads are superimposed on the same core. This is the reason why Map3D-MP actually achieves performance better than the theoretical maximum.

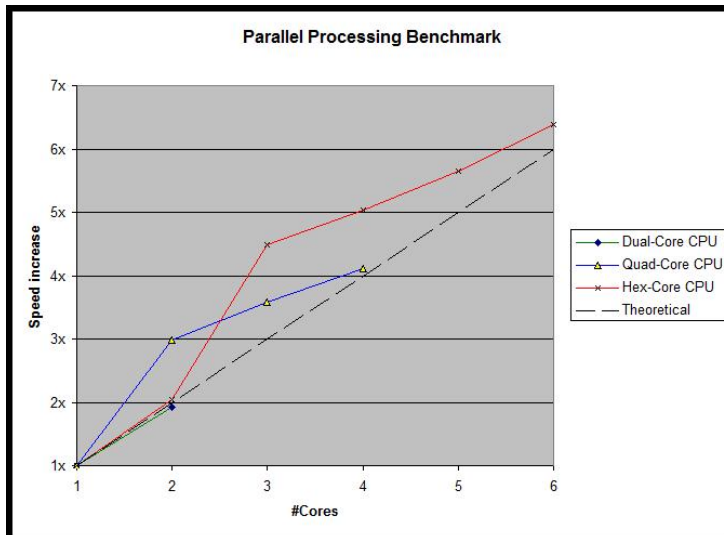

In order to achieve these performance gains it is necessary to improve both the processing power and/or disk I/O rate [Analysis > Options > Drive #](#).

#### 5.1.24 Analysis > Options > Drive #

Specify scratch drives for coefficient matrix – during Map3D BEM analysis.

If you have multiple disk drives installed, this option can be used to direct Map3D where to store the coefficient matrix. When the first drive fills up, Map3D will write the remainder of the matrix to next scratch drive.

When the solution matrix is too big to fit into RAM (refer to [Analysis > Options > VRAM](#) and [Analysis > Options > PRAM](#)), Matrix solution becomes an I/O intensive operation that depends only on the I/O rate of your computer. In this case, a large part of the analysis time can be spent in the solution stage due to slow disk performance.

To overcome this problem it is imperative that the user install multiple, high speed disks.

Map3D fully supports parallel processing and parallel disk I/O with the multi-processor/multi-drive option.

If you are licensed to use the multi-processor/multi-drive option, Map3D set up these drives into a RAID array such that I/O is done in an overlapped manner to all of the drives, in parallel with the computations.

Set up in this way you can increase the I/O performance in proportion to the number of drives in the

array.

In the following benchmark, the same model is run with 1, 2 and 4 disks.

	1 disk	2 disks	4 disks	8GB PRAM
Measured Disk Throughput (MB/sec)	55	112	206	3000 equivalent
Matrix Solution (hours)	0.546	0.282	0.163	0.033
Solution Speed Increase	1x	1.9x	3.3x	16x
Total Analysis Time (4 cores)	0.640	0.376	0.257	0.107
Total Speed Increase	1x	1.7x	2.5x	6x

The disks used in this benchmark are older 50-60 MB/sec drives (Seagate Barracuda 7200.7). More recent mechanical drives perform at 100 MB/sec (Seagate Momentus 7200.4). SATA2 SSDs can provide over 250 MB/sec per drive. SATA3 SSDs can provide over 500 MB/sec per drive. Multiple SSDs can be expected to perform as fast as PRAM. Note that some motherboards have limitations on the total combined throughput and may require add-in controller adapters.

To determine if you are licensed to use the multi-processor/multi-drive option check on [Analysis > Options > #C/T](#).

If you are licensed to use the multi-processor/multi-drive option, faster disk rates can be achieved if you set SE\_MANAGE\_VOLUME\_NAME privilege.

This capability is available in the following versions of Windows:

- Windows NT 4.0, Windows 2000 Professional and Server (maximum of 4 GB).
- Windows 2000 Advanced Server (maximum of 8 GB).
- Windows 2000 Datacenter Server (maximum of 32 GB).
- Windows XP Professional and Windows Server 2003 (maximum of 4 GB).
- Windows Server 2003 Enterprise Edition (maximum of 32 GB).
- Windows Server 2003 Datacenter Edition (maximum of 64 GB).

To set "SE\_MANAGE\_VOLUME\_NAME" privilege, follow these steps:

[Control Panel > Administrative Tools > Local Security Policies](#)

Then set

[Local Policies > User Rights Assignment > Perform Volume Maintenance Tasks > Add User or Group > Everyone](#)

You must reboot for this setting to take effect.

Notes:

This function must be checked before conducting the Map3D BEM analysis

[Analysis > BEM Analysis](#)

You should specify the fastest drive in your system. You can test your drive performance using [Tools > Disk Performance Test](#)

### 5.1.25 Analysis > Options > Move Points

Move field points that are very close to boundary surfaces – during Map3D BEM analysis.

Field points (results on [grid planes](#) or at [user defined points](#)) that are located within a fraction of an element width from an element corner or edge will have very poor accuracy often indicating unrealistically large stress concentrations. By moving such points to the nearest boundary node, more realistic stress predictions can be obtained. This option only moves points that are within  $\frac{1}{4}$  of AG (AG is the minimum allowable grid spacing, see [Analysis > CParams > AG](#)) from the surface.

This feature also causes field points that are just inside excavations (within  $\frac{1}{2}$  of AG) to be moved onto the excavation surface, and thus provides smooth contouring of results right up to the excavation surface.

Notes:

This function must be checked before conducting the Map3D BEM analysis

[Analysis > BEM Analysis](#).

It is recommended that you check this option unless you specifically do not want field points moved.

### 5.1.26 Analysis > Options > MSCALC

Calculate results at user defined points – during Map3D BEM analysis.

Analysis results can be calculated at user defined coordinate locations.

When you select MSCALC, you will be prompted for a data file name and the desired output format as follows.

#### Data file format:

The data file contains is simply a text file (\*.txt) with a list of the coordinate locations where the results are to be calculated.

The format of this file requires one set of coordinates per line

```
X1 Y1 Z1  
X2 Y2 Z2  
X3 Y3 Z3  
X4 Y4 Z4  
...
```

where  $x_i$   $y_i$   $z_i$  represent the coordinates of each point.

#### Output file format:

Results are written back to the same data file with x y z coordinates followed by user specified parameters

User defined output - Results at MSCALC points

x y z

Stresses

s1 ts1 ps1 s2 ts2 ps2 s3 ts3 ps3 user  Effective  Ind  
 Total  Abs

sxx syy szz sxy syz sxz tmax toct smean s1i ts1i ps1i s3i ts3i ps3i  
 ti tti pti si tsi psi s1u ts1u ps1u s3u ts3u ps3u

Strains

e1 te1 pe1 e2 te2 pe2 e3 te3 pe3  Elas  Plas  Ind  
 Tot  Abs

exx eyy ezz exy eyz exz emax eoct evol esi tsi psi eni teni peni e1i te1i pe1i e3i te3i pe3i  
 esu tsu psu enu tenu penu e1u te1u pe1u e3u te3u pe3u

Displacements

ut tut put ux uy uz  
 uni tuni puni umi tumi pumi  
 unu tunu punu umu tumu pumu

Thermal/Fluid Flow

t qt tqt pqt qx qy qz  
 qni tqni pqni qmi tqmi pqmi  
 qnu tqnu pqnu qmu tqmu

Tilt

duxdx duxdy duxdz duydx duydy duydz  
 duzdx duzdy duzdz

Miscellaneous

matl# step#

? Cartesian Principal OK Cancel

### Stresses:

[s1 ts1 ps1](#) major principal stress  $\sigma_1$  its trend and plunge.

[s2 ts2 ps2](#) intermediate principal stress  $\sigma_2$  its trend and plunge.

[s3 ts3 ps3](#) minor principal stress  $\sigma_3$  its trend and plunge.

[user](#) User defined value.

[sxx syy szz sxy syz sxz](#) Cartesian stress components.

[tmax](#) maximum shear stress  $\tau_{max} = \frac{1}{2} (\sigma_1 - \sigma_3)$

[toct](#) octahedral shear stress  $\tau_{oct} = \frac{1}{3} [(\sigma_1 - \sigma_2)^2 + (\sigma_2 - \sigma_3)^2 + (\sigma_3 - \sigma_1)^2]^{1/2}$

[smean](#) mean stress  $\sigma_{mean} = \frac{1}{3} (\sigma_1 + \sigma_2 + \sigma_3)$

[ti tti pti](#) maximum shear stress in the grid plane, its trend and plunge.

[si tsi psi](#) normal stress in the grid plane, its trend and plunge.

[s1i ts1i ps1i](#) maximum stress tangential to the grid plane, its trend and plunge.

[s3i ts3i ps3i](#) minimum stress tangential to the grid plane, its trend and plunge.

[tu ttu ptu](#) maximum shear stress in the ubiquitous-plane, its trend and plunge.

[su tsu psu](#) stress normal to the ubiquitous plane, its trend and plunge.

[s1u ts1u ps1u](#) maximum stress tangential to the ubiquitous plane, its trend and plunge.

[s3u ts3u ps3u](#) minimum stress tangential to the ubiquitous plane, its trend and plunge.

The orientation of the ubiquitous-plane is specified in

 [Plot > Strength Factors > Ubiquitous Parameters](#)

[Effective/Total](#) effective stress or total stress components. These options are only used in [Map3D Thermal-Fluid Flow](#), as this code allows for calculation of steady state pore pressure distributions.

[Induced/Absolute](#) Induced stress is the stress without the pre-mining stress contribution. This represents the stress change since the pre-mining condition. Absolute stress is the stress including the pre-mining stress contribution.

### Strains:

[e1 te1 pe1](#) major principal strain  $\epsilon_1$  its trend and plunge.

[e2 te2 pe2](#) intermediate principal strain  $\varepsilon_2$  its trend and plunge.  
[e3 te3 pe3](#) minor principal strain  $\varepsilon_3$  its trend and plunge.  
[exx eyy ezz exy eyz exz](#) Cartesian strain components.  
[emax](#) maximum shear strain  $\varepsilon_{\max} = \frac{1}{2} (\varepsilon_1 - \varepsilon_3)$   
[eoct](#) octahedral shear strain  $\varepsilon_{\text{oct}} = \frac{1}{3} [(\varepsilon_1 - \varepsilon_2)^2 + (\varepsilon_2 - \varepsilon_3)^2 + (\varepsilon_3 - \varepsilon_1)^2]^{1/2}$   
[evol](#) volumetric strain  $\varepsilon_{\text{vol}} = (\varepsilon_1 + \varepsilon_2 + \varepsilon_3)$   
[esi tesi pesi](#) maximum shear strain in the grid plane, its trend and plunge.  
[eni teni peni](#) normal strain in the grid plane, its trend and plunge.  
[e1i te1i pe1i](#) maximum strain tangential to the grid plane, its trend and plunge.  
[e3i te3i pe3i](#) minimum strain tangential to the grid plane, its trend and plunge.  
[esu tesu pesu](#) maximum shear strain in the ubiquitous-plane, its trend and plunge.  
[enu tenu penu](#) strain normal to the ubiquitous plane, its trend and plunge.  
[e1u te1u pe1u](#) maximum strain tangential to the ubiquitous plane, its trend and plunge.  
[e3u te3u pe3u](#) minimum strain tangential to the ubiquitous plane, its trend and plunge.  
[Elastic/Plastic/Total](#) elastic, plastic or total strain components. These options are only used in [Map3D Non-Linear](#), as this code allows for calculation of non-linear strains.  
[Induced/Absolute](#) Induced strain is the strain without the pre-mining contribution. This represents the strain change since the pre-mining condition. Absolute strain is the strain including the pre-mining strain contribution.

#### Displacements:

[ut tut put](#) total displacement, its trend and plunge.  
[ux uy uz](#) Cartesian displacement components.  
[uni tuni puni](#) displacement normal to the grid plane, its trend and plunge.  
[umi tumi pumi](#) maximum displacement tangential to the grid plane, its trend and plunge.  
[unu tunu punu](#) displacement normal to the ubiquitous plane, its trend and plunge.  
[umu tumu pumu](#) maximum displacement tangential to the ubiquitous plane, its trend and plunge.

#### Flow:

[t](#) temperature/head.  
[qt tqt pqt](#) total flow, its trend and plunge.  
[qx qy qz](#) Cartesian flow components.  
[qni tqni pqni](#) displacement normal to the grid plane, its trend and plunge.  
[qmi tqmi pqmi](#) maximum displacement tangential to the grid plane, its trend and plunge.  
[qnu tqnu pqnu](#) displacement normal to the ubiquitous plane, its trend and plunge.  
[qmu tqmu pqmu](#) maximum displacement tangential to the ubiquitous plane, its trend and plunge.

#### Miscellaneous:

[matl#](#) the number of the material within which the point is located. The host material is material number 1. In problems where multiple materials are used, results may be calculated in an alternate material zone.  
[step#](#) the mining step number.

#### Other:

[Cartesian](#) configures for output of cartesian stress components.  
[Principal](#) configures for output of principal stress components.

#### Notes:

This function must be checked before conducting the discretization analysis

[Analysis > Discretization](#).

Any desired number of points can be specified.

The model is discretized according to the locations of the specified points.

### 5.1.27 Analysis > Options > Initialization

Initialize the model so that the analysis continues from where a previous analysis completed.

This option enables you to start a new analysis from where a previous model completed. All non-linear, zero strain and seismic loading (seismic loading only in [Map3Di](#)) components are passed on to the new model from the previous analysis.

In order for this function to work properly the new model must have all of the model data (geometry) that the initialization model has plus any new data, mining steps or grids. There is no requirement to use the same discretization or grid planes.

In order to initialize the following files must be intact:

[file.00n](#) where n represents the mining step number where the previous analysis finished.

[file.dms](#) this file is only used with the zero strain option ([Analysis > Options > Zero Strain Support Placement](#)).

[file.hms](#) this file is only used by [Map3Di](#) and are used to accumulate the field loading as the analysis progresses.

Notes:

This function must be checked before conducting the Map3D BEM analysis

[Analysis > BEM Analysis](#)

This option requires additional calculations and hence increases analysis time.

Refer to [Analysis > Options > Restart](#) to restart an analysis that was aborted or interrupted by a power failure or operating system crash.

### 5.1.28 Analysis > Options > Initialization file name

Displays the name of the initialization file [file.00n](#) where n represents the mining step number where the previous analysis finished.

[Analysis > Options > Initialize](#)

### 5.1.29 Analysis > Options > LERD/LSS

Calculate energy release rate and loading system stiffness – during Map3D BEM analysis.

This routine enables the user to calculate energy release rate (*ERR*) at any desired location and provides a wide range of flexibility for controlling how the calculation is conducted. An alternative method is available where *ERR* is calculated ahead of an excavation face only  [Plot > Surface Components > ERR](#)



When you select LERD/LSS, you will be prompted for a data file name where the results from the LERD/LSS calculations are to be written. The default extension for this file is ".ERR".

Results will be written to this file in the following format:

If the test block is constructed as a 3D block (using FF elements)

**Block# Volume Area W<sub>k</sub> W<sub>f</sub> LSS x y z  $\sigma_1$  t<sub>1</sub> p<sub>1</sub>  $\sigma_2$  t<sub>2</sub> p<sub>2</sub>  $\sigma_3$  t<sub>3</sub> p<sub>3</sub>**

where  $\sigma_i$  t<sub>i</sub> p<sub>i</sub> represent a principal stress component, its trend and plunge.

If the test block is constructed as a planar feature (using DD elements)

**Block# Volume Area W<sub>k</sub> W<sub>f</sub> LSS x y z  $\tau_s$  t<sub>s</sub> p<sub>s</sub>  $\sigma_n$  t<sub>n</sub> p<sub>n</sub>**

where  $\tau_s$  t<sub>s</sub> p<sub>s</sub> represent the maximum in-plane shear stress, its trend and plunge, and  $\sigma_n$  t<sub>n</sub> p<sub>n</sub> represent the normal stress, its trend and plunge.

In both cases, x y z are the coordinates of the centre of the test block where the stresses are calculated.

In addition, the total energy release associated with new excavations made during for the current mining step will also be calculated. Note that no test blocks need to be specified for this calculation to take place. Results will be reported as follows:

**Stp# Volume Area W<sub>k</sub> W<sub>f</sub>**

A useful indicator of the nature of the response expected during yielding are the loading system stiffness (*LSS*) and local energy release density (*LERD*). At different locations in a model one can expect these indicators to change owing to geometric effects. At locations where the *LSS* is stiffer that the post peak response of the yielding rock, one can expect controlled failure that progresses in sequence with the advancing mining. However, at locations where the *LSS* is softer that the post peak response of the yielding rock, one can expect uncontrolled failures. The amount of excess energy available can be expected to correlate with the magnitude of the event.

In order to determine the *LSS* or *LERD* in a numerical model it is necessary to flex the model and observe the loading system response. This is done by specification of the Material Code for the LERD/LSS calculation using

 [CAD > Edit > Entity Properties > Matl Code LERD/LSS](#)

This special Material Code is used to temporarily alter the material properties or boundary conditions in the test area to cause the model to deform in some way.

Since the *LSS* is expected to change from one location to another, it is necessary do this at all locations of interest. By carefully monitoring the loading system response during this deformation, the *LSS* and the various amounts of energy transferred can be calculated.

Consider the simple example of a fault plane passing through a mining zone, and ask the question "How would this fault respond if it were to yield?". One could simply substitute a lower friction angle and observe how the rock mass deformed. Let's call "Stage I" the model with the fault at its normal friction angle, and "Stage II" the same model but with the fault at some reduced friction angle. At some location on the fault plane we can expect the following type of response.

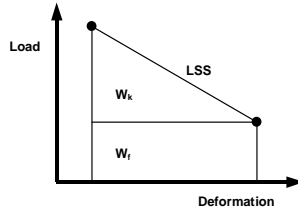

The *LSS* is simply the slope of the load deformation response curve. The maximum amount of energy that can be released as kinetic energy is the area of the upper triangle labelled as  $W_k$  (one should expect this to correlate with observed event magnitude). The minimum amount of energy that can be dissipated in the frictional deformation of the fault is the area of the lower rectangle labelled as  $W_f$  (one should expect this to correlate with the amount of damage observed at the event source). This calculation must be conducted at all locations on the fault plane in order to get the total energy transferred as a result of the reduction in friction angle. Note that depending on how the material properties are set up there could be normal deformations (dilation occurring with the shear response) that this must be included in the energy calculations.

The same calculations can be done for a pillar between two drifts. For this case let's call "Stage I" the model with the pillar intact. In order to flex the model we could substitute a different material into the pillar and call this "Stage II". All of the above calculations and interpretations for  $W_k$  and  $W_f$  can then be taken again. Note that as above, there will be contributions from both normal and shear components included in the energy calculations.

Since Map3D calculates the stresses acting on boundary elements, the total energy transfer can be calculated as the integral of the stresses through their deformations over all elements. In the case of the pillar example above, if we actually excavate the pillar to obtain stage II, then divide  $(W_k + W_f)$  by the volume of the pillar, we obtain the local energy release density (*LERD*). This has been found to correlate very well with violent failure episodes. (Note that for the case of tabular mining, if you divide  $(W_k + W_f)$  by the area (in the plane of mining), you obtain the classical energy release rate, *ERR*).

To reinforce this concept let's consider a real example. Consider multiple pillar bursts that occurred over several years of mining. For each failure, a numerical model was run to determine the stress state at the time and location of the failure. If we plot all of these stress predictions on a set of  $\sigma_1$  versus  $\sigma_3$  axes we obtain the following:

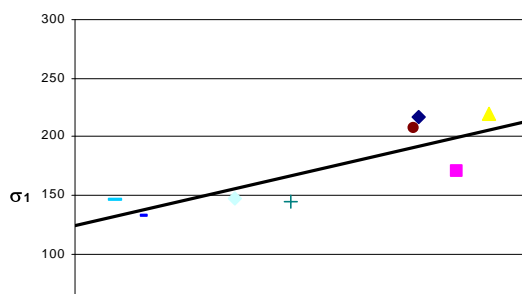

This figure illustrates that there is a strong correlation between the stress state at the time of each burst and a linear strength criterion. The coefficient of correlation of this data is 0.90. Stated in a different way, the mean error in prediction of  $\sigma_1$  is approximately 17 MPa. This gives a coefficient of variation of only 9%.

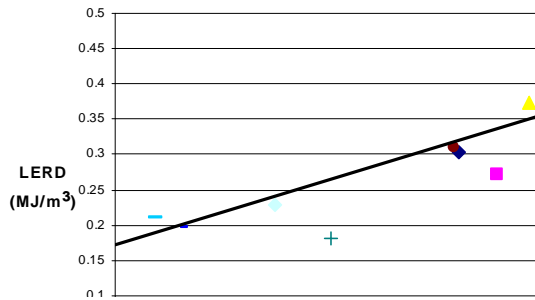

The *LERD* at the time of the burst as each location also shows a strong correlation between the stress state at the time of each burst and a linear criterion. The coefficient of correlation of this data is 0.88. Stated in a different way, the mean error in prediction of *LERD* is approximately 0.045 MPa/m<sup>2</sup>. This gives a coefficient of variation of only 14%.

While the *W<sub>k</sub>* and *W<sub>f</sub>* components are readily calculated in this way, the definition of *LSS* is not so straightforward. However a representative *LSS* can be determined as follows:

Identify a representative area for which the *LSS* is to be determined. This is done by building a test block that should encompass the anticipated yield zone.

You construct the test block as you would any other feature, but identify this block as a "test block" by specifying the desired Material Code for the *LERD/LSS* calculation using

 [CAD > Edit > Entity Properties > Matl Code LERD/LSS](#)

The Material Code for the Mining Steps should be set according to how you want this zone to be treated during the mining sequence. These blocks can be used as alternate material zones and excavated if desired.

Assuming that this test block is filled with a fictitious material whose post-peak stiffness exactly matches the loading system response, and that the behaviour of the test block can be described by

$$\sigma_1 = LSS \epsilon_1 \quad \sigma_2 = LSS \epsilon_2 \quad \sigma_3 = LSS \epsilon_3$$

The energy density can be calculated as

$$\frac{1}{2} ( \sigma_1 \epsilon_1 + \sigma_2 \epsilon_2 + \sigma_3 \epsilon_3 )$$

The mean energy density can be estimated as

$$( W_k + W_f ) / Volume$$

Hence the loading system stiffness can be determined from

$$LSS = \frac{1}{2} ( \sigma_1^2 + \sigma_2^2 + \sigma_3^2 ) Volume / ( W_k + W_f )$$

If we do this calculation for the data presented above we obtain the following plot.

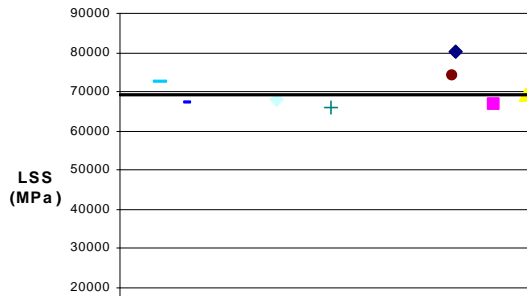

The *LSS* at the time of the burst at each location shows a strong stress independent value. The mean error in prediction of *LSS* is approximately 4730 MPa. This gives a coefficient of variation of only 7%.

This *LSS* calculation is only representative provided the stresses are uniformly distributed throughout the test block. In cases where this is not true, poor correlation with *LSS* is found.

### Notes

This function must be checked before conducting the discretization analysis

[Analysis > Discretization](#)

### 5.1.30 Analysis > Options > LERD/LSS file name

Displays the file name where results from the LERD/LSS calculations are to be written

[Analysis > Options > LERD/LSS](#)

### 5.1.31 Analysis > Options > Linear

Use higher order boundary elements – during Map3D BEM analysis.

The Boundary Element Method utilizes a numerical approximation of how the intensity of the surface components of stress or displacement discontinuity are distributed over the boundaries. The simplest assumption is to assume that these surface components are distributed uniformly over each boundary element. Experience with Map3D has shown that accurate results are obtained with this approximation for all but a limited class of problems where there are significant bending effects involved. Even for this later type of problem, accurate results are still obtained at all locations except near the boundary surfaces.

To obtain accurate results near the boundaries of problems where there are significant bending effects involved it is necessary to implement higher order boundary elements. Bending effects normally become important for problems with large spans that are irregularly shaped. This is particularly important near kinks in the boundary that can arise due to intersections between various features.

When this option is checked, the intensity of the surface components of stress or displacement discontinuity are distributed over the boundary elements using a higher order polynomial distribution. For triangles a linear distribution is used

$$a + bx + cy$$

For quadrilaterals, the following distribution is used

$$a + b x + c y + d x y$$

Notes:

This function must be checked before conducting the Map3D BEM analysis

[Analysis > BEM Analysis](#)

This option will increase problem size and hence analysis time, since higher order elements require more interpolation nodes on the bounding surfaces.

If the user is uncertain about the sensitivity of their model to this approximation, it is suggested that some subset of the actual model is run with and without linear elements for comparison.

### 5.1.32 Analysis > Options > Lumping

Pre-calculate coefficient matrix size – during discretization analysis.

To accurately determine the amount of scratch disk space required to store the coefficient matrix during a Map3D BEM analysis, it is necessary to conduct a lumping procedure. This option executes the lumping procedure during the discretization analysis (i.e. prior to the Map3D BEM analysis).

The boundary element method generates a fully populated coefficient matrix of size  $4 \cdot n^2$  bytes, where  $n$  is the number of degrees of freedom. Even for small problems, disk space requirements and analysis time can become quite large (e.g. 20,000 degrees of freedom requires 2 GBytes of disk space without lumping). Large problems quickly become impractical to solve (e.g. 200,000 degrees of freedom requires 160 GBytes of disk space without lumping). To overcome this problem a procedure called matrix lumping is conducted in Map3D. This typically achieves a reduction of coefficient matrix size by a factor of 10 times for small problems and more than 100 times for larger problems.

Notes

This function must be checked before conducting the discretization analysis

[Analysis > Discretization](#).

The matrix lumping procedure is conducted during the Map3D BEM analysis whether this option is selected or not.

This is a time consuming procedure that should only be conducted if you need to accurately determine disk space requirements prior to Map3D BEM analysis.

### 5.1.33 Analysis > Options > Lumping Accuracy

When this option is checked, lumping will only be allowed between adjacent elements that share the same local coordinate system (i.e. parallel normals and parallel sides). This ensures relatively good accuracy of lumped zones.

When this option is not checked, lumping will be allowed between all adjacent elements regardless of the orientation. This procedure will result in increased lumping and hence smaller coefficient matrix size, but at the expense of reduced accuracy of the results.

The boundary element method generates a fully populated coefficient matrix of size  $4 \cdot n^2$  bytes,

where  $n$  is the number of degrees of freedom. Even for small problems, disk space requirements and analysis time can become quite large (e.g. 20,000 degrees of freedom requires 2 GBytes of disk space without lumping). Large problems quickly become impractical to solve (e.g. 200,000 degrees of freedom requires 160 GBytes of disk space without lumping). To overcome this problem a procedure called matrix lumping is conducted in Map3D. This typically achieves a reduction of coefficient matrix size by a factor of 10 times for small problems and more than 100 times for larger problems.

Notes

This function must be checked before conducting the discretization analysis

[Analysis > Discretization](#)

Refer to [Analysis > Options > Lumping](#) for information on lumping.

### 5.1.34 Analysis > Options > Planar

Subdivide non-planar quadrilaterals into triangles – during intersection analysis.

Moderately non-planar surfaces do not pose a problem for Map3D. However, extreme warping of surfaces can interfere with the intersection analysis.

Notes

This function must be checked before conducting the intersection analysis

[Analysis > Intersections.](#)

This can result in an increase in problem size thus increasing analysis time.

It is recommended that do not check this option unless you specifically want to eliminate non-planar features.

### 5.1.35 Analysis > Options > P-ram

Store part of the coefficient matrix in physical RAM – during Map3D BEM analysis.

If your computer has a large amount of RAM installed, this option may significantly speed execution since data can be retrieved from RAM much more quickly than from disk. Although Windows 32 bit only allows each process to address 2GB, for users with large amounts of RAM in their computer, physical RAM can be accessed using AWE (Address Windowing Extensions). AWE allows access to all available RAM in your computer. Most systems can support 4GB of RAM. Some can support more than 64GB. Various versions of Windows provide different levels of AWE support varying from 1GB up to 512GB. AWE support is available in the following versions of Windows:

- Windows NT 4.0, Windows 2000 Professional and Server (maximum of 4 GB).
- Windows 2000 Advanced Server (maximum of 8 GB).
- Windows 2000 Datacenter Server (maximum of 32 GB).
- Windows XP Professional and Windows Server 2003 (maximum of 4 GB).
- Windows Server 2003 Enterprise Edition (maximum of 32 GB).
- Windows Server 2003 Datacenter Edition (maximum of 64 GB).
- Windows 7 & 8.

AWE requires "SE\_LOCK\_MEMORY" privilege. To enable AWE, follow these steps:

[Control Panel > Administrative Tools > Local Security Policies](#)

Then set

[Local Policies > User Rights Assignment > Lock Pages in Memory > Add User or Group > Everyone](#)

You must reboot for this setting to take effect.

Notes:

This function must be checked before conducting the Map3D BEM analysis

[Analysis > BEM Analysis.](#)

You should only allocate the amount of RAM you want Map3D to use making sure to leave adequate space for any other applications you intend to run.

You should never set this parameter larger than the available RAM since this will result in excessive paging of your operating system which will significantly slow down the analysis.

### 5.1.36 Analysis > Options > Precondition

Precondition the matrix – during Map3D BEM analysis.

This option instructs Map3D to search through the matrix for unreasonably large off diagonal coefficients. These normally result from construction errors and are disabled when this option is checked.

Notes:

This function must be checked before conducting the Map3D BEM analysis

[Analysis > BEM Analysis](#)

It is recommended that this option be used.

### 5.1.37 Analysis > Options > Renumber

Renumber surfaces so the volume is positive – during file load.

Map3D surfaces are defined with a top and bottom to enable distinction between the inside and outside of excavations, alternate material zones, etc. Other CAD packages may specify surfaces in a manner inconsistent with the Map3D convention. This option rennumbers all surfaces with the Map3D convention such that they form zones with a positive volume.

Notes

This function must be checked before loading the model file

[Analysis > Load Model.](#)

It is strongly recommended that you check this option.

### 5.1.38 Analysis > Options > Reset

Set all analysis options to their default (recommended) settings.

### 5.1.39 Analysis > Options > V-ram

Store part of the coefficient matrix in virtual RAM – during Map3D BEM analysis.

If your computer has a large amount of RAM installed, this option may significantly speed execution since data can be retrieved from RAM much more quickly than from disk. Unfortunately Windows 32 bit only allows each process to address 2GB. After you remove overheads this leaves only about 1GB for auxiliary storage, even if you have plenty of RAM. For users with large amounts of RAM in their computer, an alternative is to use physical RAM ([Analysis > Options > P-ram](#)) instead of virtual RAM.

Notes:

This function must be checked before conducting the Map3D BEM analysis

[Analysis > BEM Analysis](#).

You should only allocate the amount of RAM you want Map3D to use making sure to leave adequate space for any other applications you intend to run.

You should never set this parameter larger than the available RAM since this will result in excessive paging of your operating system which will significantly slow down the analysis.

### 5.1.40 Analysis > Options > Verbose

Write all solution vectors and field point results to the log file – during Map3D BEM analysis.

Notes:

This function must be checked before conducting the Map3D BEM analysis

[Analysis > BEM Analysis](#)

It is recommended that you do not check this option unless you specifically want to see this information in the log file.

### 5.1.41 Analysis > Options > Zero Strain Placement

Use zero strain support placement – during Map3D BEM analysis.

This option enables simulation of ground support elements. When simulating stiff support systems such as arches, steel sets, props, thick liners, chinks, strong backfill etc., it is necessary to model the ground movement up to the point of support placement, then insert the support elements either in a stress/strain free state, or with a prescribed pre-stressing. This feature is particularly useful for simulation of structural support elements and can accommodate placement, modification of properties and subsequent removal if desired. This option has been enabled for use with 3D FF blocks and/or DD planes.

To enable this feature you must first excavate the desired support element (either a 3D FF block or DD plane) to the desired pre-stressed state (use a zero material code for zero stresses or a negative



material number for a prescribed stress state), then in a subsequent mining step insert the support material (use a positive material number to do this). With the Analysis > Options > Zero Strain Support Placement option checked, Map3D conducts the necessary calculations to place support elements in a stress/strain free state or with a prescribed pre-stressing at the current mining step. The action of excavation to a zero or prescribed stress state followed by insertion of an alternate material signals Map3D to conduct the required calculations.

Without this option, all materials are placed at the pre-mining deformation state. This can cause erroneous large stresses particularly in stiff support elements.

Notes:

This function must be checked before conducting the Map3D BEM analysis

[Analysis > BEM Analysis](#)

This option requires additional calculations and hence increases analysis time.

### 5.1.42 Analysis > Suspend

Suspends execution of the analysis.

Select Analysis > Resume to continue execution.

### 5.1.43 Analysis > Conclude

Concludes the current analysis.

During matrix solution Map3D is attempting to progressively solve the simultaneous equations saved in the coefficient matrix along with any other equations describing the alternate material zones, fault-slip, creep etc. A converged solution is assumed to have been obtained when the maximum surface stress error and the maximum failure criterion error are reduced below the user specified stress tolerance *STOL*

[Analysis > CParams > STOL](#)

If the user is satisfied the current level of accuracy is acceptable, the analysis can be concluded by checking this option.

Extreme caution should be exercised when using this function as the results will contain numerical errors which could be significant.

Notes:

The distribution of surface stress error can be displayed by selecting

 [Plot > Surface Components > Serr](#) Stress Error

from the solve toolbar.

The distribution of failure criterion error can be displayed by selecting

 [Plot > Surface Components > Ferr](#) Failure Error

from the solve toolbar.

During analysis, the solve toolbar will be displayed when you suspend the analysis

[Analysis > Suspend](#)

only if the

[Tools > Solve Toolbar](#)

has been checked.

#### 5.1.44 Analysis > Disable

Disables boundary elements that have a surface stress error (*Serr*) greater than ten times the root mean square value (*Rms*) for all elements.

During matrix solution Map3D is attempting to progressively solve the simultaneous equations saved in the coefficient matrix along with any other equations describing the alternate material zones, fault-slip, creep etc. A converged solution is assumed to have been obtained when the maximum surface stress error and the maximum failure criterion error are reduced below the user specified stress tolerance *STOL*

[Analysis > CParams > STOL](#)

In some problems, certain elements will not converge to a solution due to excessively poor numerical conditioning. If the user is satisfied the current level of accuracy, a solution can be forced by checking this option.

This function instructs Map3D to disable any elements with values of *Serr* > 10 *Rms*. A few iterations after executing this function, additional elements may appear with the same problem requiring this function to be executed again. After a few times all elements will be disabled and the solution can proceed to convergence.

Extreme caution should be exercised when using this function as the results will contain numerical errors which could be significant.

Notes:

The distribution of surface stress error can be displayed by selecting

 [Plot > Surface Components > Serr](#) Stress Error

from the solve toolbar.

The distribution of failure criterion error can be displayed by selecting

 [Plot > Surface Components > Ferr](#) Failure Error

from the solve toolbar.

During analysis, the solve toolbar will be displayed when you suspend the analysis

[Analysis > Suspend](#)

only if the

[Tools > Solve Toolbar](#)

has been checked.

### 5.1.45 Analysis Dialog

Displays a scrollable dialogue of analysis activity including:

INFO: messages describing current operations.

WARNING: messages describing possible inconsistencies that may cause problems.

ERROR: messages describing errors that will cause program execution to terminate.

During matrix solution Map3D is attempting to progressively solve the simultaneous equations saved in the coefficient matrix along with any other equations describing the alternate material zones, fault-slip, creep etc. A converged solution is assumed to have been obtained when the maximum surface stress error

 [Plot > Surface Components > Serr](#) Stress Error

and the maximum failure criterion error

 [Plot > Surface Components > Ferr](#) Failure Error

are reduced below the user specified stress tolerance *STOL*

[Analysis > CParams > STOL](#)

As the solution progresses, summary information regarding the solution is displayed:

**is=1 it=3 ser=-1.29E+01 fer= 0.00E+00 rms=5.85E+00 ratio=0.414 converging**

**is** - current time step number.

- This counter is only used for non-linear creep analyses (including fault-slip and 3D material non-linearity).
- Map3D uses an implicit solution method to solve the visco-plastic part of creep problems.
- Each time Map3D reaches an equilibrium creep solution, the creep strain increments are added to the total plastic strains and then a new time step is begun (i.e. the is counter is incremented).

**it** - current iteration count.

- Map3D uses an iterative solution method to solve the simultaneous equations saved in the coefficient matrix.
- This counter refers to the cumulative number of iterations executed.

**ser** - maximum surface stress error.

- Iterative solvers function by determining the error in the current solution of each simultaneous equation, then reducing these errors by a process of successive approximations.
- This parameter indicates the maximum error for all of the equations.

**fer** - maximum failure criterion error.

- This parameter is only used for non-linear creep analyses (including fault-slip and 3D material non-linearity).
- This parameter should always be near zero unless some viscosity has been specified and the problem goes non-linear.
- In this latter case, viscous creep can allow stress states above the failure criterion, thus indicating a lack of static equilibrium.
- This parameter indicates the maximum viscous stress for all of the equations.

**rms** - root mean square of all surface stress errors.

**ratio** - ratio of the current value of **rms** divided by the value of **rms** at the previous iteration.

- This provides an indications of how quickly the solution is progressing.

**converging** - indicator that the problem is converging.

- This indicator may also read diverging if the ratio is greater than one.

Notes:

Since smooth scrolling limits the rate at which information can be written to the information area, it can considerably slow down the Map3D analysis. It is recommended that smooth scrolling not be used

[Tools > Smooth Scroll](#)

## 5.2 CAD

### 5.2.1 CAD > Properties > Map3Di Setup > View

This option enables visualization of Map3Di data.

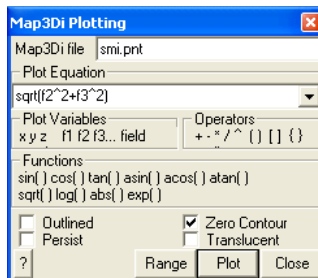

#### Map3Di File:

The Map3Di data file is simply an ASCII data file with the default extension ".PNT".

Refer to [CAD > Properties > Map3Di](#) for details concerning data format.

Refer to [Visualization > Plane > Make Map3Di File](#) for details concerning data format.

#### Plot Equation:

Defines the parameter that will be plotted.

The pull-down window allows you to store up to 20 different equations. These are stored between Map3D sessions in the map3d.ini file.

#### Plot Variables:

`f1 f2 f3...` - data fields in the event file.

#### Functions:

`sin()` `cos()` `tan()` - sine, cosine and tangent trigonometric functions.

`asin()` `acos()` `atan()` - Inverse trigonometric functions.

`sqrt()` - square root function.

`log()` - natural logarithmic function.

`abs()` - absolute value.

`exp()` - exponential function (antilogarithm).

#### Location:

$x y z$  - coordinate of grid point.

### Operators:

$+ - * / ^$  addition, subtraction, multiplication, division and exponentiation operators. Note that exponentials are computed first, followed by multiplication and division and finally addition and subtraction.

$() [] \{ \}$  styles of brackets. Pairs of brackets must match.

$>$  maximum value. For example if the plot equation is specified as  $f1 > 10$ , the larger of  $f1$  or 10 will be plotted.

$<$  minimum value. For example if the plot equation is specified as  $f1 < 10$ , the smaller of  $f1$  or 10 will be plotted.

### Point Plotting Options:

**Outlined** – Map3Di data patches are outlined.

### Other:

**Persist** – when checked, the points will be re-plotted each time the model is reoriented, translated or zoomed. Since this may be time consuming for large models this option may not always be desired.

**Translucent** - draws the points as translucent spheres.

**Zero Contour** - when unchecked, contours below the minimum contour range are not drawn. This is useful for displaying contours where only the upper part of the contour range is important.

**Range** – specifies the minimum, maximum and interval for radius scaling and contouring.

 **Plot** - regenerates the plot. This button can be placed on either the View Toolbar ([Tools > View Toolbar Configure](#)) or the Contour Toolbar ([Tools > Contour Toolbar Configure](#)).

## 5.2.2 CAD > Build > Block Mesh Spacing

Specifies the desired block mesh spacing.

When building Blocks

 [CAD > Build > Block](#)

 [CAD > Build > FF Loop](#)

 [CAD > Build > DD Loop](#)

surfaces will be subdivided into smaller parts at the specified mesh spacing.

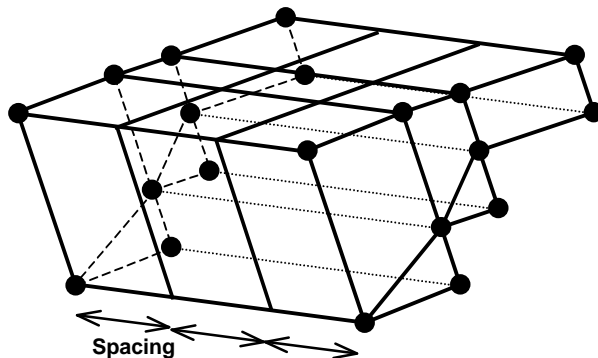















### 5.2.3 CAD > Snap

Activates the snap toolbar.



Snap functions assist in visually selecting points from the model during block building and other editing functions.

This toolbar is meant to provide quick access to the snap functions that are used in the [model building and editing stage](#) of the Map3D BEM analysis [Analysis > Go to CAD](#)

-  [CAD > Snap > None](#) Disable snapping.
-  [CAD > Snap > Edge](#) Snap to the nearest edge.
-  [CAD > Snap > Corner](#) Snap to the nearest corner.
-  [CAD > Snap > Midpoint](#) Snap to the midpoint of the selected edge.
-  [CAD > Snap > Tangent Snap](#) Force cursor tangent to the selected edge.
-  [CAD > Snap > Intersection Snap](#) Snap to the intersection of the selected edge and a tangent.
-  [CAD > Snap > Trace Cline Snap](#) Snap to selected corners along a construction line segment.
-  [CAD > Snap > Trace Cloop Snap](#) Snap to all corners along a construction line segment.
-  [CAD > Snap > Grid Snap](#) Snap to a rectangular grid.
-  [CAD > Snap > Cylinder Snap](#) Snap to a circular grid.
-  [CAD > Snap > X-Grid Snap](#) Snap to the selected edge at an even X grid spacing.
-  [CAD > Snap > Y-Grid Snap](#) Snap to the selected edge at an even Y grid spacing.
-  [CAD > Snap > Z-Grid Snap](#) Snap to the selected edge at an even Z grid spacing.
-  [CAD > Snap > Cursor/Grid Setup](#) Setup the cursor/grid spacing and orientation.

### 5.2.4 CAD > Edit









Activates the edit toolbar.











This toolbar is meant to provide quick access to the edit functions that are used in the [model building and editing stage](#) of the Map3D BEM analysis [Analysis > Go to CAD](#)

Edit functions are grouped into two sections depending on whether you want to modify blocks or coordinates.

#### Modify blocks:

-  [CAD > Edit > Entity Properties](#) Edit block type, colour, mining sequence etc.
-  [CAD > Edit > Erase Entities](#) Erase selected entities.
-  [CAD > Edit > Move Entities](#) Move selected entities.
-  [CAD > Edit > Copy Entities](#) Copy selected entities.
-  [CAD > Edit > Scale Entities](#) Scale selected entities.
-  [CAD > Edit > Rotate Azimuth](#) Rotate the azimuth of selected entities.
-  [CAD > Edit > Rotate Dip](#) Rotate the dip of selected entities.
-  [CAD > Edit > Dump to File](#) Dump selected entities to a file.
-  [CAD > Edit > Group](#) Group selected entities into a single block.

**Modify coordinates:**

-  [CAD > Edit > Stretch Vertices](#) Stretch selected vertices.
-  [CAD > Edit > Move Vertices to Point](#) Move selected vertices to a point.
-  [CAD > Edit > Move Vertices to X](#) Move the x-coordinate of selected vertices.
-  [CAD > Edit > Move Vertices to Y](#) Move the y-coordinate of selected vertices.
-  [CAD > Edit > Move Vertices to Z](#) Move the z-coordinate of selected vertices.
-  [CAD > Edit > Move Vertices to Plane](#) Move selected vertices to a plane.
-  [CAD > Edit > Smooth Construction Lines](#) Smooth construction lines.
-  [CAD > Edit > Remove Construction Vertex](#) Remove a construction vertex.
-  [CAD > Edit > Subdivide Construction Lines](#) Subdivide a construction line.

**Undo - Redo**

Once you have completed any edit operation you have one chance to undo the modifications by selecting

 Undo

You can also restore the same selection set and modify the same set of entities again by selecting

 Redo

Pressing the space-bar automatically activates the last edit function that was used.

**5.2.5 CAD > Edit > Entity Properties > DDPlane Thickness**

Specifies the thickness of the material inserted into the DD element (i.e. fault gouge, seam width, mining width or pillar height).

Normal displacement (closure) of the feature when in-filled will be limited to this thickness. Also, the normal displacement (closure) and shear displacement (ride) are divided by the thickness to determine the strain occurring in the in-filling material.

This parameter should be specified in the same units used to specify the coordinate positions (e.g. metres or feet). This parameter is not used for 3D FF blocks.

Related topics:

 [CAD > Edit > Entity Properties](#)

**5.2.6 CAD > Edit > Entities**









Edit grid name and maximum spacing.

When you initiate this routine you will first be prompted to build a list of entities that you wish to edit



- If [Tools > Shift-key Selection](#) is checked, you must hold down the shift key to make multiple selections.
- Use of this toolbar is detailed in [Build A List of Entities for Editing](#)
- Pressing the space-bar automatically activates the last edit function that was used.

Once you have selected the desired entities, you can either pick any of the edit buttons:

-  [CAD > Edit > Entity Properties](#) Edit block type, colour, mining sequence,
-  [CAD > Edit > Erase Entities](#) Erase selected entities,
-  [CAD > Edit > Move Entities](#) Move selected entities,
-  [CAD > Edit > Copy Entities](#) Copy selected entities,
-  [CAD > Edit > Scale Entities](#) Scale selected entities,
-  [CAD > Edit > Rotate Azimuth](#) Rotate the azimuth of selected entities,
-  [CAD > Edit > Rotate Dip](#) Rotate the dip of selected entities,
-  [CAD > Edit > Dump to File](#) Dump selected entities to a file,
-  [CAD > Edit > Group](#) Group selected entities into a single block,

- double click on any vertex to execute the highlighted function,
- right click for a list of options.

If any of the fields in the dialogue box read "Variable" it is because some of the blocks you have selected have different properties for that field. If you wish to leave these properties as they are (i.e. different for each block), leave the field as "Variable". If you wish to change the value of that field for all selected blocks, enter the desired value.

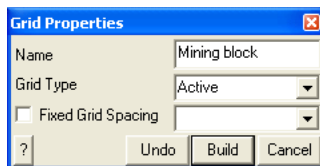

**Name** - specifies a descriptive name for the grid.

**Grid Type** - specifies whether you want the grid to be active (used in the stress analysis) or inactive (not used in the stress analysis).

**Maximum Spacing** - specifies the maximum spacing permitted.

- This parameter can be used to force fine uniform discretization on selected grids. Extreme caution should be used in specifying this value since a small value can easily lead to enormous problem size.
- In general this parameter should be left blank (i.e. not used), and discretization should be left to the **AG** parameter. This latter parameter will concentrate elements only where analysis results are requested thus optimizing the use of elements and minimizing problem size.

[CAD > Properties Control Parameters.](#)

- If this field is left blank this parameter is not used.

**OK** - completes editing of blocks and modifies any properties that have been changed.

**Cancel** - aborts editing of entities.

Once you have completed any edit operation you have one chance to undo the modifications by selecting

 Undo

You can also restore the same selection set and modify the same set of entities again by selecting

 Redo

You can adjust the double click time using

[Tools > Double Click Time](#)



## 5.2.7 CAD > Edit > Entities

Edit construction line colour.

When you initiate this routine you will first be prompted to build a list of entities that you wish to edit



- If [Tools > Shift-key Selection](#) is checked, you must hold down the shift key to make multiple selections.
- Use of this toolbar is detailed in [Build A List of Entities for Editing](#)
- Pressing the space-bar automatically activates the last edit function that was used.

Once you have selected the desired entities, you can either pick any of the edit buttons:

- [CAD > Edit > Entity Properties](#) Edit block type, colour, mining sequence,
- [CAD > Edit > Erase Entities](#) Erase selected entities,
- [CAD > Edit > Move Entities](#) Move selected entities,
- [CAD > Edit > Copy Entities](#) Copy selected entities,
- [CAD > Edit > Scale Entities](#) Scale selected entities,
- [CAD > Edit > Rotate Azimuth](#) Rotate the azimuth of selected entities,
- [CAD > Edit > Rotate Dip](#) Rotate the dip of selected entities,
- [CAD > Edit > Dump to File](#) Dump selected entities to a file,
- [CAD > Edit > Group](#) Group selected entities into a single block,

- double click on any vertex to execute the highlighted function,
- right click for a list of options.

If any of the fields in the dialogue box read "Variable" it is because some of the blocks you have selected have different properties for that field. If you wish to leave these properties as they are (i.e. different for each block), leave the field as "Variable". If you wish to change the value of that field for all selected blocks, enter the desired value.

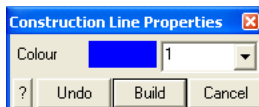

**Colour** - specifies the colour number that will be used to display the construction line.

- A total of 10 colours are available for display. These are numbered respectively
  - 1 through 10,
  - 11 through 20,
  - 21 through 30, etc.,
- such that the same colour is displayed for numbers
  - 1, 11, 21...,
  - 2, 22, 32...,
  - 3, 23, 33..., etc.

**OK** - completes editing of construction lines and modifies any properties that have been changed.

**Cancel** - aborts editing of entities.

Once you have completed any edit operation you have one chance to undo the modifications by

selecting

 Undo

You can also restore the same selection set and modify the same set of entities again by selecting

 Redo

You can adjust the double click time using

[Tools > Double Click Time](#)

For examples on the use of construction lines in model building refer to:

[Model Building Tutorials](#)

## 5.2.8 CAD > Edit > Build A List of Entities for Editing

This routine can be initiated either by picking any edit function (e.g.  button) or simple right-clicking on any entity.

When you initiate any entity editing routine you will first be prompted to build a list of entities that you wish to edit





- If [Tools > Shift-key Selection](#) is checked, you must hold down the shift key to make multiple selections.
- By default, selected entities are added to the list, however if the Ctrl-key is held down, selected entities will be removed from the list.
- While holding down the Shift-key or Ctrl-key, you can drag open a crossing window.
- Pressing the space-bar automatically activates the last edit function that was used.
- Holding the Alt-key when you right-click automatically repeats the last edit function that was used.

This toolbar controls the various functions used in list building.

 Off Aborts editing.

 Surf Select entities by picking one surface at a time.

 Ent Select entities by picking whole groups making up a block.

 Num Include all entities with the selected number.

 Col Include all entities with the selected colour.

 Mtrl Include all entities with the selected material number.

- The same block may have different materials in it depending on the currently active mining step.

- When using this function, make sure to select the appropriate mining step  [File > Mining Step](#)

 Step Include all entities excavated with the selected mining step number.

 Win Include all entities within the selected window.

- Entities will only be selected if the entire entity is contained within the window.

- If  (surface select mode) is active, only surfaces will be included.



- If  (entity select mode) is active, all surfaces making up the block will be included.





 Crs Include all entities within the crossing window.

- Entities will be selected if even a part of the entity is within the window.









- This function can also be activated by holding down the Shift-key or Ctrl-key and dragging open

a crossing window.

- If  (surface select mode) is active, only surfaces will be included.
- If  (entity select mode) is active, all surfaces making up the block will be included.

-  Selected entities will be added to the list.
-  Selected entities will be removed from the list.
-  Undo last selection.
-  Redo the last section.

Once you have selected the desired entities, you can either pick any of the edit buttons:

-  [CAD > Edit > Entity Properties](#) Edit block type, colour, mining sequence etc.
-  [CAD > Edit > Erase Entities](#) Erase selected entities.
-  [CAD > Edit > Move Entities](#) Move selected entities.
-  [CAD > Edit > Copy Entities](#) Copy selected entities.
-  [CAD > Edit > Scale Entities](#) Scale selected entities.
-  [CAD > Edit > Rotate Azimuth](#) Rotate the azimuth of selected entities.
-  [CAD > Edit > Rotate Dip](#) Rotate the dip of selected entities.
-  [CAD > Edit > Dump to File](#) Dump selected entities to a file.
-  [CAD > Edit > Group](#) Group selected entities into a single block.

- double click on any vertex to execute the highlighted function,
- right click for a list of options.

Once you have completed any edit operation you have one chance to undo the modifications by selecting

 Undo

You can also restore the same selection set and modify the same set of entities again by selecting

 Redo

You can adjust the double click time using

[Tools > Double Click Time](#)

## 5.2.9 CAD > Edit > Build A List of Vertices for Editing









This routine can be initiated either by picking any edit function (e.g.  button) or simple right-clicking on any vertex.

When you initiate any entity editing routine you will first be prompted to build a list of vertices that you wish to edit.











- If [Tools > Shift-key Selection](#) is checked, you must hold down the Shift-key to make multiple selections.
- By default, selected entities are added to the list, however if the Ctrl-key is held down, selected entities will be removed from the list.
- While holding down the Shift-key or Ctrl-key, you can drag open a selection window.
- Pressing the space-bar automatically activates the last edit function that was used.
- Holding the Alt-key when you right-click automatically repeats the last edit function that was used.

This toolbar controls the various functions used in list building.

-  Off Aborts editing.
-  Pick Select vertices by picking one at a time.
-  Enter Select vertices by picking groups.
-  Win Include all entities within the selected window.
  - Entities will only be selected if the entire entity is contained within the window.
  - This function can also be activated by holding down the Shift-key or Ctrl-key and dragging open a crossing window.
-  Add Selected entities will be added to the list.
-  Rem Selected entities will be removed from the list.
-  Undo last selection.
-  Redo the last section.

Once you have selected the desired entities, you can either pick any of the edit buttons:

-  [CAD > Edit > Stretch Vertices](#)
-  [CAD > Edit > Move Vertices to Point](#)
-  [CAD > Edit > Move Vertices to X](#)
-  [CAD > Edit > Move Vertices to Y](#)
-  [CAD > Edit > Move Vertices to Z](#)
-  [CAD > Edit > Move Vertices to Plane](#)
-  [CAD > Edit > Smooth Construction Lines](#)
-  [CAD > Edit > Remove Construction Vertex](#)
-  [CAD > Edit > Subdivide Construction Lines](#)

- double click on any vertex to execute the highlighted function,
- right click for a list of options.

Once you have completed any edit operation you have one chance to undo the modifications by selecting

 Undo

You can also restore the same selection set and modify the same set of entities again by selecting

 Redo

You can adjust the double click time using

[Tools > Double Click Time](#)

### 5.2.10 CAD > Digitizer > Activate

Activates the digitizer for selecting points from a drawing to set up the digitizer, refer to

[CAD > Digitizer Setup](#)

## 5.2.11 CAD > Properties > Material Properties > Stress State

Pre-mining Stress State	
Datum	1000
$\sigma_{Hmax}$ constant	30
$\sigma_{Hmin}$ constant	20
$\sigma_{Vert}$ constant	20
$\Delta\sigma_{Hmax}$ variation	-0.027000000
$\Delta\sigma_{Hmin}$ variation	-0.013000000
$\Delta\sigma_{Vert}$ variation	-0.013000000
$\sigma_{Hmax}$ trend	0
$\sigma_{Hmax}$ plunge	0
$\sigma_{Vert}$ trend	0
t/h constant	0
$\Delta t/h$ variation	0
? Copy from... Cartesian Close	

**Datum** - The pre-mining stress state is specified as a linear variation with depth in either principal or Cartesian components.

**Copy from...** - allows you to copy the stress state from another material.

- Only the stress state is copied.
- Other material properties are left unchanged.

**Cartesian** - The pre-mining stress state is specified as a linear variation with depth in either principal or Cartesian components.

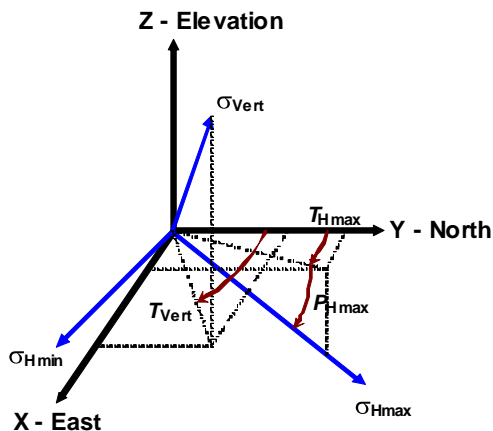

The three principal stress components are referred to as the *Hmax*, *Hmin* and *Vert* components.

- $\sigma_{Hmax}$  is the maximum (nearly) horizontal stress.
- $\sigma_{Hmin}$  is the minimum (nearly) horizontal stress.
- $\sigma_{Vert}$  is the (nearly) vertical stress.

These stress components are perpendicular to one another.

The horizontal and vertical components do not need to be exactly horizontal or vertical.

The trend and plunge of  $\sigma_{Hmax}$  can be adjusted using  $T_{Hmax}$  and  $P_{Hmax}$ .

The trend of  $\sigma_{Vert}$  can be adjusted using  $T_{Vert}$ .

The variation of each of these components is described as a linear variation with depth as (for example for the  $\sigma_{Hmax}$  component)

$$\sigma_{Hmax} + \Delta\sigma_{Hmax} (z - Datum)$$

To determine appropriate values for each of these components the user must first select a depth ( $z = Datum$ )

where the stresses have known values. These later values are the

$$\sigma_{Hmax} \quad \sigma_{Hmin} \quad \sigma_{Vert}$$

constant values.

The variation of each component with depth can then be specified as

$$\Delta\sigma_{Hmax} \quad \Delta\sigma_{Hmin} \quad \Delta\sigma_{Vert}$$

variation values. If you have set up your coordinate system with  $z$  positive up, then the variations should be specified as negative quantities so that the stresses increase with depth.

For example if you know that the  $Hmax$  component has a value of

$$30 \text{ MPa at } z = 1000\text{m}$$

and varies as ( $z$  is positive up)

$$0.027 \text{ MPa/m}$$

you would specify

$$Datum = 1000$$

$$\sigma_a = 30$$

$$\Delta\sigma_a = -0.027$$

Finally, the trend and plunge of the  $Hmax$  component and the trend of the  $Vert$  component uniquely define the stress state orientation.

The parameters

$t/h$  constant

$\Delta t/h$  variation

refer to the ambient temperature/head distribution and are specified in the same manner as the stresses.

## 5.2.12 CAD > Properties > Material Properties > Stress State > Cartesian

The pre-mining stress state is specified as a linear variation with depth in either Cartesian or [principal components](#).

Parameter	Value
Datum	1000
$\sigma_{xx}$	20
$\sigma_{yy}$	30
$\sigma_{zz}$	20
$\tau_{xy}$	0
$\tau_{yx}$	0
$\tau_{xz}$	0
$\Delta\sigma_{xx}$	-0.01300000
$\Delta\sigma_{yy}$	-0.02700000
$\Delta\sigma_{zz}$	-0.01300000
$\Delta\tau_{xy}$	0
$\Delta\tau_{yx}$	0
$\Delta\tau_{xz}$	0

The variation of each of the Cartesian components is described as a linear variation with depth as (for example for the  $\sigma_{xx}$  component)

$$\sigma_{xx} + \Delta\sigma_{xx} (z - Datum)$$

To determine appropriate values for each of these components the user must first select a depth

$$(z = Datum)$$

where the stresses have known values. These later values are the

$$\sigma_{xx} \quad \sigma_{yy} \quad \sigma_{zz} \quad \tau_{xy} \quad \tau_{yx} \quad \tau_{xz}$$

constant values.

The variation of each component with depth can then be specified as

$$\Delta\sigma_{xx} \quad \Delta\sigma_{yy} \quad \Delta\sigma_{zz} \quad \Delta\tau_{xy} \quad \Delta\tau_{yx} \quad \Delta\tau_{xz}$$

variation values. If you have set up your coordinate system with  $z$  positive up, then the variations should be specified as negative quantities so that the stresses increase with depth.

For example if you know that the  $\sigma_{xx}$  component has a value of

$$30 \text{ MPa at } z = -1000\text{m}$$

and varies as ( $z$  is positive up)

$$0.027 \text{ MPa/m}$$

you would specify

$$Datum = -1000$$

$$\sigma_{xx} = 30$$

$$\Delta\sigma_{xx} = -0.027$$

### 5.2.13 CAD > Properties > Material Properties > Stress State > Datum

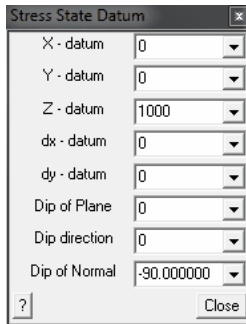

The variation of each of the stress components is described as a linear variation in either principal or Cartesian components.

If desired this can be specified as a variation in the x, y and z directions by defining a sloping datum. This is meant to be used at locations where the topography has a dominant slope.

To define a sloping datum, you are required to specify a point on the plane that represents the datum (*X-datum*, *Y-datum* and *Z-datum*), as well as the slope of the plane. The slope is specified as a gradient in the X (*dx-datum*) and Y (*dy-datum*) directions.

For user convenience, the slope of the place can be specified using either the "Dip" and "Dip direction" of the plane, or the "Dip direction" and "Dip of the Normal" to the plane. The gradients are automatically determined from these later values as follows:

$$\begin{aligned} dx\text{-datum} &= -\sin(\theta) \sin(\varphi) \\ dy\text{-datum} &= -\cos(\theta) \sin(\varphi) \end{aligned}$$

hence

$$\begin{aligned} \tan(\theta) &= dx/dy \\ \tan(\varphi) &= \sqrt{dx^2 + dy^2} \end{aligned}$$

Defined in this way, the stresses vary both with depth and horizontal position.

### 5.2.14 CAD > Build

Activate the Build toolbar.

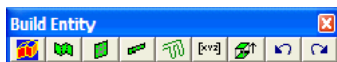







This toolbar is meant to provide quick access to the entity building functions that are used in the [model building and editing stage](#) of the Map3D BEM analysis [Analysis > Go to CAD](#).

 [CAD > Build > FF Loop](#) Build a multi-cornered 3D, FF type block used for excavations and alternate material zones.

 [CAD > Build > DD Loop](#) Build a multi-cornered DD type block used for tabular mining, thin seams or fault planes.



-  [CAD > Build > Grid Plane](#) Build a grid plane where analysis results are calculated.
-  [CAD > Build > Grid Line](#) Build a grid line where analysis results are calculated.
-  [CAD > Build > Construction Lines](#) Build construction lines to define detailed locations of underground features such as excavations, contacts structure etc.
-  [CAD > Build > Enter Point](#) Enter coordinate values for a point.
-  [CAD > Build > Offset Remaining](#) Offset remaining points.
-  [CAD > Build > Undo Point](#) Undo last point selection.
-  [CAD > Build > Redo Point](#) Redo last point selection.

Pressing the space-bar automatically activates the build edit function that was used.

## 5.3 File

### 5.3.1 File > Open > Merge Materials

If this option is checked, as the new model file is loaded, the material data in the new file is merged with the current material data.

If this option is not checked, as the new model file is loaded, the material data in the new file will replace the current material data.

This allows you to keep your material models in separate data files then incorporate them into models as required.

Related Topics:

[File > Open > Merge Geometries.](#)

### 5.3.2 File > Output > Animated GIF Recorder > Append Images

When checked, new images will be appended to an existing animation.

### 5.3.3 File > PNT Output File Format

PNT format is a universal ASCII data file with the extension ".PNT".

This format is useful for exchanging raw model data with other CAD software.

Comment lines start with an asterisk "\*" in column 1.

Surfaces are stored as a series of polylines as follows:

```
x1 y1 z1 3 value1
x2 y2 z2 2 value2
x3 y3 z3 2 value3
x4 y4 z4 2 value4
...
```

$x_1 y_1 z_1$  represent the coordinates of each point.

3 indicates that this point is the beginning of a new line.

2 indicates that this point is a continuation of the same line.

**value:** for geometric entities this represents the colour number for the surface

For contours this represents the value of the contoured parameter at each corner of the surface.

### 5.3.4 File > PNT Construction Line File Format

PNT format is a universal ASCII data file with the extension ".PNT".

This format is useful for exchanging raw model data with other CAD software.

Comment lines must start with an asterisk "\*" in column 1.

Construction lines are stored as a series of polylines as follows:

```
x1 y1 z1 3 colour
x2 y1 z1 2
x3 y3 z3 2
x4 y4 z4 2
...
```

$x_i$   $y_i$   $z_i$  represent the coordinates of each point.

3 indicates that this point is the beginning of a new line.

2 indicates that this point is a continuation of the same line.

colour specifies the colour number that will be used to display the construction line.

A total of 10 colours are available for display.

These are numbered respectively 1 through 10, 11 through 20, 21 through 30, etc., such that the same colour is displayed for number 1, 11, 21, 31..., 2, 22, 32..., etc.

Any number of points can be specified for each polyline.

Additional polylines are specified by repeating the sequence (i.e. starting a new line with the number 3).

Notes

Different colour numbers should be used to represent logical groupings of construction lines (e.g. for different levels, sections or logical mining units such as development, stoping etc.). These colours are user definable using

[Tools > Custom Colours.](#)

Since it is easy to toggle on and off the display of specific construction line colour numbers, this provides an efficient method to work with complex construction line data

 [View > Hide Cline Colours.](#)

### 5.3.5 File > PNT Model File Format

PNT format is a universal ASCII data file with the extension ".PNT".

This format is useful for exchanging raw model data with other CAD software.

Comment lines must start with an asterisk "\*" in column 1.

Map3D FF blocks and DD planes are stored as a series of polylines as follows:

**x<sub>1</sub> y<sub>1</sub> z<sub>1</sub> 3 colour mtype**  
**x<sub>2</sub> y<sub>1</sub> z<sub>1</sub> 2**  
**x<sub>3</sub> y<sub>3</sub> z<sub>3</sub> 2**  
**x<sub>4</sub> y<sub>4</sub> z<sub>4</sub> 2**  
**x<sub>5</sub> y<sub>5</sub> z<sub>5</sub> 1**  
**x<sub>6</sub> y<sub>6</sub> z<sub>6</sub> 1**  
**x<sub>7</sub> y<sub>7</sub> z<sub>7</sub> 1**  
**x<sub>8</sub> y<sub>8</sub> z<sub>8</sub> 1**  
...

where **x<sub>i</sub> y<sub>i</sub> z<sub>i</sub>** represent the coordinates of each point,  
**3** indicates that this point is the beginning of a new polyline,  
**2** indicates that this point forms part of the base of the block,  
**1** indicates that this point forms part of the top of the block. This item is only used for definition of 3D block shapes.

**colour** specifies the colour number that will be used to display the block.

A total of 10 colours are available for display.

These are numbered respectively 1 through 10, 11 through 20, 21 through 30, etc., such that the same colour is displayed for number 1, 11, 21, 31..., 2, 22, 32..., etc.

**mtype** specifies the type of boundary element that will be used for the block.

For three-dimensional features such as excavations, alternate material zones, back-filled stopes etc., Fictitious Force type 1 elements should be used

 [CAD > Build > Block](#) and  [CAD > Build > Block](#) for details.

Displacement Discontinuity type 2 elements should be used for tabular mining excavations, fractures and fault planes

 [CAD > Build > DDLoop](#) for details.

Inactive elements (98 for inactive 3D blocks and 99 for inactive DD planes) can be used to display features that are to be included for visualization purposes only and not to be used for the actual stress analysis.

Additional polylines are specified by repeating the sequence (i.e. starting a new line with the number **3**).

### Notes

Different colour numbers should be used to represent logical groupings of blocks (e.g. for different levels, sections or logical mining units such as development, stoping etc.). These colours are user definable using

[Tools > Custom Colours](#)

Map3D will automatically combine any blocks with the same colour number into single complex shapes.

Since it is easy to toggle on and off the display of specific block colour numbers, this provides an efficient method to work with complex model data

 [View > Hide Block Colours](#)

### 5.3.6 File > Restart File Formats

Analysis results are saved in files with the extensions ".001", ".002", ".003", ..., where the number refers to the mining step number.

### 5.3.7 File > Construction Line File Formats

Construction lines can be saved in several file types:

[Point file format](#) is a universal ASCII data file with the extension ".PNT". This format is useful for exchanging raw construction line data with other CAD software.

[AutoCAD-DXF](#) format is a popular drawing exchange file with the extension ".DXF". This format is useful for exchanging construction line data with other CAD software.

Construction lines from different files can be merged. The merge option

[File > Open > Merge](#)

appears at the bottom of the open file dialogue box.

Related Topics:

[File > Open \(Construction Lines\)](#).

[File > Save As](#).

### 5.3.8 File > DXF Construction Line File Format

DXF format is an AutoCAD drawing exchange file with the extension ".DXF".

This format is useful for exchanging model data with other CAD software.

Construction lines are saved as a series of AutoCAD DXF POLYLINE entities.

Construction lines can be imported as a series of AutoCAD DXF POLYLINE, LINE, 3DLINE or 3DFACE entities.

### 5.3.9 File > DXF Model File Format

DXF format is an AutoCAD drawing exchange file with the extension ".DXF".

This format is useful for exchanging model data with other CAD software.

#### Three-Dimensional Block Type AutoCAD Entities

The most reliable method of generating Map3D compatible data is to use three-dimensional AutoCAD entities. This type of entity generates blocks, which are structured identically to Map3D 3D FF blocks and thus can be passed directly through to Map3D. Closure of all surfaces is guaranteed when using this command since each three-dimensional entity defines a closed block. There are many ways of generating such objects from within AutoCAD as described below.

#### 3DMESH

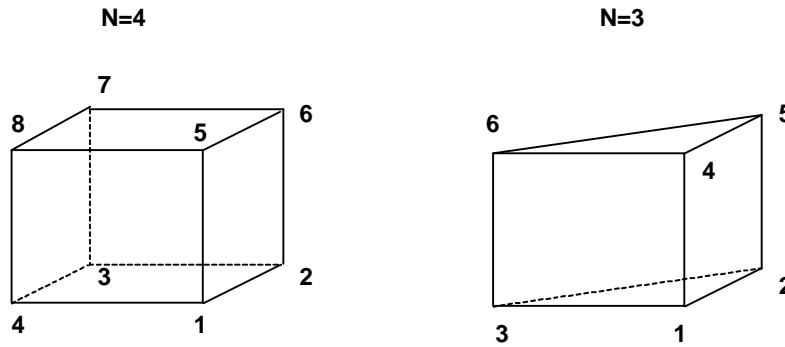

The recommended method of defining three-dimensional AutoCAD entities is to use the 3DMESH command, with AutoCAD THICKNESS and WIDTH set equal to zero. These 3DMESH's can be specified with any desired values of M and N. If N is set equal to 3 or 4, these entities will come into Map3D as blocks. This approach is the most general, but also the most complex to specify since the layout of both the floor and back of the drift must be defined along its length.

**PLINE, POLYLINE or ELLIPSE with WIDTH and THICKNESS**

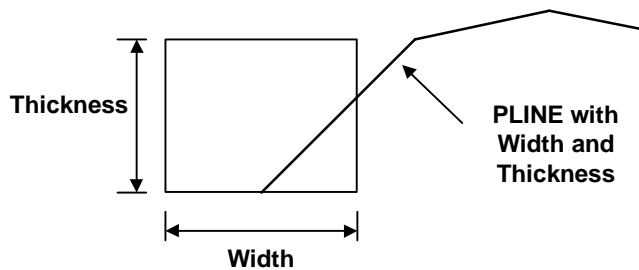

The simplest technique for generating a drift or stope with a regular rectangular cross-section, and uniform height, is to use the AutoCAD PLINE command. One simply defines an AutoCAD UCS (user coordinate system) for the drift, then defines the floor elevation centre line of the drift using the AutoCAD PLINE command. The width of the drift is then specified using the AutoCAD PEDIT command. Either a constant width or changing width at each vertex can be specified. The AutoCAD COLOUR (Map3D block number) and AutoCAD THICKNESS (drift height) of the drift are specified using the AutoCAD CHANGE PROPERTIES command. The AutoCAD POLYLINE and ELLIPSE commands can also be used to create drifts with specified AutoCAD WIDTH and THICKNESS.

**PLINE, POLYLINE or SOLID with THICKNESS Only**

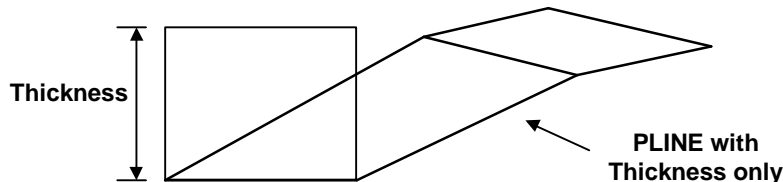

Another simple method of defining a drifts or stopes with a rectangular cross-section is to use either of the AutoCAD PLINE, POLYLINE or SOLID commands with a specified AutoCAD THICKNESS (drift height), and AutoCAD WIDTH set equal to zero (see Figure 32). Although this approach is

more general than PLINE, it is also more complex to specify since the floor plan of the drift must be defined along its length. If either the AutoCAD PLINE or POLYLINE commands are used, one must form a closed loop with either 3 or 4 line segments.

### Other Three-dimensional AutoCAD Entities

AutoCAD supplies routines to generate several three-dimensional objects including spheres, toruses, boxes, cones etc. These can all be used if desired. The user is responsible to close the open ends of shapes such as hemispheres and cones.

### Two-Dimensional Plate Type AutoCAD Entities

Map3D compatible data can also be specified in terms of two-dimensional AutoCAD entities. This technique is not as reliable as the methods described above because closure of all surfaces is no longer guaranteed. The user must define excavations with a series of surface plates (all assigned the same AutoCAD colour number), which must join along their edges and completely envelope the excavation with a continuous surface skin. These surfaces are structured identically to Map3D surface plates. Closure of all surfaces is not guaranteed when using this method since the user may leave out a surface patch, thus forming a hole in the excavation surface. The user must take care to place all plates such that all surfaces close perfectly.

### LINE, PLINE, 3DPOLY, POLYLINE and ELLIPSE - THICKNESS Only

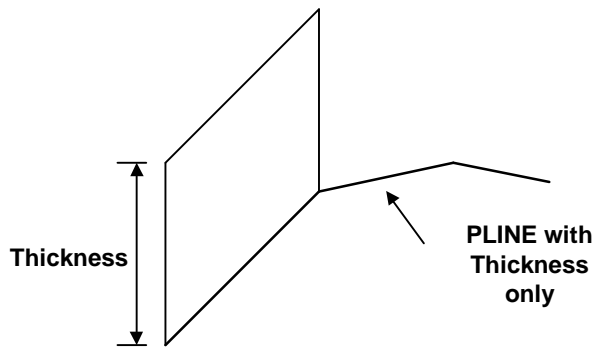

These entities can be used to define two-dimensional plates. One simply defines an AutoCAD UCS (user coordinate system) for the plate, then defines the edge of the plate using any of the AutoCAD LINE, PLINE, 3DPOLY, POLYLINE or ELLIPSE commands. The AutoCAD COLOUR (Map3D block number) and AutoCAD THICKNESS (plate width) are specified using the AutoCAD CHANGE PROPERTIES command. The AutoCAD WIDTH must be set equal to zero.

### LINE, PLINE, 3DPOLY, POLYLINE and ELLIPSE with WIDTH Only

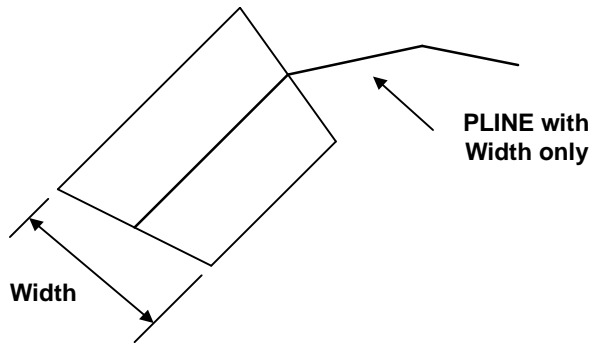

Using these entities, one defines the centre line of the plate using any of the AutoCAD LINE, PLINE, 3DPOLY, POLYLINE or ELLIPSE commands. The width is then specified using the AutoCAD PEDIT command. Either a constant width or changing width at each vertex may be specified. The AutoCAD THICKNESS must be set equal to zero.

### 3DFACE, POLYLINE or LWPOLYLINE

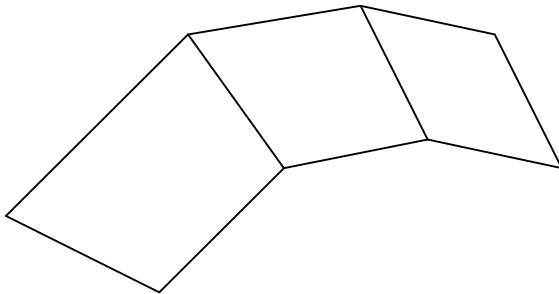

Two-dimensional surfaces can also be generated using the AutoCAD 3DFACE command. This method is more general, but since all corners of the AutoCAD 3DFACE must be specified, it is also more complex.

### 3DMESH

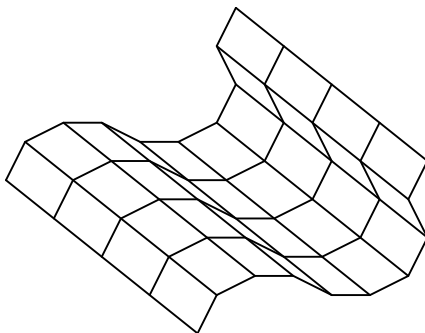

Complex two-dimensional surfaces can be generated using types of 3DMESHs with N larger than 4 (e.g. Rulesurf, Tabsurf, Revsurf etc.). For these shapes, the DXF conversion routine creates a series of 3DFACEs to describe the excavation surface. These surfaces are structured identically to Map3D surface plates. Surface closure is fairly easy to ensure for these cases owing to the regular nature of the construction.

### Unsupported AutoCAD Entities

There are a number of unsupported AutoCAD entities, meaning that Map3D was not designed to reconstruct these as they appear from within AutoCAD. These entities include the CIRCLE, ARC and DOUGHNUT entities. These entities may be supported in future Map3D updates. Note that most shapes can be generated by alternate means using the AutoCAD ELLIPSE command, or 3DMESH command.

### Dewick support using DXF

From within Deswick you can now create Map3D geometries including specification of Map3D block names, colours and mining sequence:

- Export each block using DXF-POLYLINE/POLYFACEMESH
- Deswick attributes are exported to DXF as AutoCAD Extended Entity Data.
- The attribute names (attributes names are not case sensitive) are defined as follows:
  - MAP3D\_BLOCKNAME - name of the block (default is blank).
  - MAP3D\_BLOCKCOLOR or MAP3D\_BLOCKCOLOUR - Map3D colour number (default is the Deswick defined colour number).
  - MAP3D\_BLOCKTYPE - 1 for FF, 2 for DD, 98 for inactive FF, 99 for inactive DD, 0 for grid plane (default is 1 for FF).
  - MAP3D\_MSTEP# - # is the mining step number (default is mined at step 1).
  - MAP3D\_BLOCKNUMBER - unique block identifier number (default is a different unique number for each DXF-POLYLINE/POLYFACEMESH or each DXF-3DFACE).
- Attributes names are not case sensitive.
- All attributes can be defined as strings (group code 1000), integers (group code 1070 or 1071) or real numbers (group code 1040).
- All attributes are optional - defaults are supplied as specified above.
- Note that if no Map3D defined attributes are specified, the DXF will read in successfully provided you are using DXF-POLYLINE/POLYFACEMESH.
- Map3D will simply assume that each DXF-POLYLINE/POLYFACEMESH is a separate block.
- If you are using multiple DXF-3DFACEs, Map3D may have difficulty grouping these into blocks.
- Problems with this occur only where adjacent blocks share their corners and have the same name.
- MAP3D\_BLOCKNUMBER can be used to identify the DXF-3DFACEs that belong to separate blocks.

### 5.3.10 File > INP Model File Format

INP format is an editable ASCII data file with the extension ".INP".

This is the recommended Map3D model format. All Map3D functionality is supported with this format.

The file is organized into 7 sections:

1. Job Title
2. Control Parameters
3. Block Specification
4. Coordinate Specification
5. Material Property Specification
6. Grid Specification



## 7. Mining Step Specification

Comment lines must start with an asterisk "\*" in column 1.

Blank lines are skipped.

Maximum line length is 256 characters.

Commas or spaces can be used to separate data fields.

### 1. Job Title

This section permits the user to specify a descriptive project title:

1 line of data must be specified.

Quotation marks are not necessary.

Only the first 70 characters will be used.

### 2. Control Parameters

This section permits the user to specify job control parameters.

***NLD,NIT,NPS RPAR,STOL AL,AG DOL,DON DOC,DOE,DOG,DOR***

1 line of data must be specified.

All parameters must appear on one line.

Only the first 7 parameters (***NLD,NIT,NPS RPAR,STOL AL,AG***) must be specified. The remaining parameters will be assigned default values, which may or may not be appropriate for your application.

For a detailed description of parameters refer to [CAD > Properties > Control Parameters](#)

***NPS*** This item specifies the number of planes of symmetry to be used in the analysis. Normally no planes of symmetry are used. If symmetry is used, the far field stresses ([Stress State](#)) must be aligned with the axis of symmetry.

***NPS=0*** no symmetry

***NPS=1***  $x \Leftrightarrow -x$ , the geometry is reflected in the y-z plane

***NPS=2***  $x \Leftrightarrow -x$  and  $y \Leftrightarrow -y$ , the geometry is reflected in the y-z and x-z planes

***NPS=3***  $x \Leftrightarrow -x$ ,  $y \Leftrightarrow -y$  and  $z \Leftrightarrow -z$ , the geometry is reflected in the y-z, x-z, and x-y planes

***RPAR*** During the matrix solution process, the relaxation parameter is continuously modified by the program in an attempt to obtain convergence with as few as possible iterations. This parameter limits the maximum value that will be used. The suggested value of 1.2 is recommended for well-conditioned problems. For very poorly conditioned problems a value of 0.8 should be used.

### 3. Block Specification

This section permits the user to define the model geometry. 3D FF Blocks and DD planes are constructed here.

***N 'Block\_Name' I1,I2,I3,I4 I5,I6,I7,I8 Type Thickness,Width***

1 line of data per block must be specified.

All parameters must appear on one line.

Only the first 5 parameters (***N I1,I2,I3,I4***) must be specified.

Use ***N=0*** to end the list of blocks.

For a detailed description of parameters refer to

 [CAD > Build > Block](#)

 [CAD > Build > FF Loop](#)

 [CAD > Build > DD Loop](#)

**N** specifies the block colour number. It is used to identify this block when setting material codes, and also to set the colour of the block for graphics display. Different colour numbers should be used to represent logical groupings of blocks (e.g. for different levels, sections or logical mining units such as development, stoping etc.). As many blocks as possible should use the same block identification number.

A total of 10 colours are available for display. These are numbered respectively

1 through 10,  
11 through 20,  
21 through 30, etc.,

such that the same colour is displayed for numbers

1, 11, 21...,  
2, 22, 32...,  
3, 23, 33..., etc.

'**Block Name**' specifies a descriptive name for the Block (e.g. 4540 stope). The program will use this name when supplying information concerning the block volume, errors and warnings. The block name is optional, but if used it must appear in single quotation marks. Only the first 20 characters of any block name will be used.

**I1, I2, I3, I4 I5, I6, I7, I8** represent the numbers of coordinate points that form the block corners, These are described in detail below.

**Type** specifies which type of boundary element to use. Inactive elements (98 or inactive FF and 99 for inactive DD) can be used to display features that are to be included for visualization purposes only and not to be used for the actual stress analysis.

For three-dimensional features such as excavations, alternate material zones, back-filled stopes etc., **Type=1** (Fictitious Force) type elements should be used.

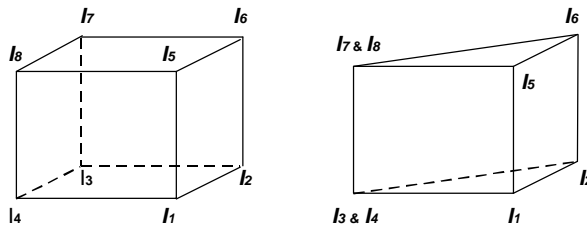

The first 4 corners (**I1, I2, I3, I4**) represent coordinate numbers that define one side (e.g. the bottom) of a 6 sided block. The next 4 corners (**I5, I6, I7, I8**) define the opposite side of the block (e.g. the top). The corners can be entered in either clockwise or counter clockwise orientation. Any of the corners can be repeated to define 3 sided shapes and wedges. Blocks can be linked together to form larger more complex excavation shapes by using common coordinate numbers to specify adjacent blocks.

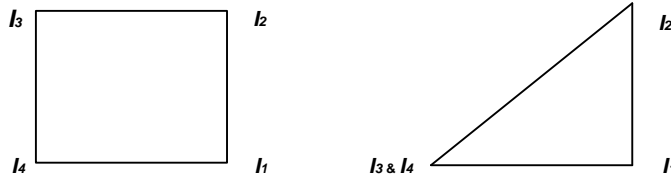

If desired, surfaces can be constructed using 3 or 4 sided surfaces by using only the first 4 corners (**I1,I2,I3,I4**). The next 4 corners (**I5,I6,I7,I8**) should be specified as zeros. The corners can be entered in either clockwise or counter clockwise orientation. Any of the corners can be repeated to define 3 sided shapes and wedges.

These surfaces can be linked together to form larger more complex excavation shapes by using common coordinate numbers to specify adjacent plates. The user must take care to ensure that complete closing surfaces are constructed leaving no holes or missing plates.

**Type=2** (Displacement Discontinuity) type elements should be used for tabular mining excavations, fractures and fault planes.

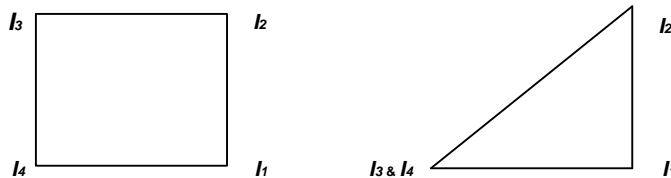

Surfaces are constructed using 3 or 4 sided surfaces by using only the first 4 corners (**I1,I2,I3,I4**).

The next 4 corners (**I5,I6,I7,I8**) should be specified as zeros. The corners can be entered in either clockwise or counter clockwise orientation. Any of the corners can be repeated to define 3 sided shapes and wedges.

These surfaces can be linked together to form larger more complex shapes by using common coordinate numbers to specify adjacent surfaces.

**Thickness** This parameter is only used for type 2 (displacement discontinuity) elements, where it is used to specify the apparent thickness of the in-filling material (i.e. fault gouge, seam width, mining width or pillar height). Normal displacement (closure) of this feature when in-filled will be limited to this thickness. Also, the normal displacement (closure) and shear displacement (ride) are divided by the *Thickness* to determine the strain occurring in the in-filling material. This parameter should be specified in the same units that are used to specify the coordinate positions (i.e. metres or feet).

**Width** specifies the maximum width permitted.

This parameter can be used to force uniform discretization on selected entities. Extreme caution should be used in specifying this value since a small value can easily lead to enormous problem size.

In general this parameter should be left blank (i.e. not used), and discretization should be left to the **AL** and **AG** parameters. These latter parameters will concentrate elements only where analysis results are requested thus optimizing the use of elements and minimizing problem size.

For an example of the use of this parameter refer to [Tabular Mining Example](#).

### A Simple Example

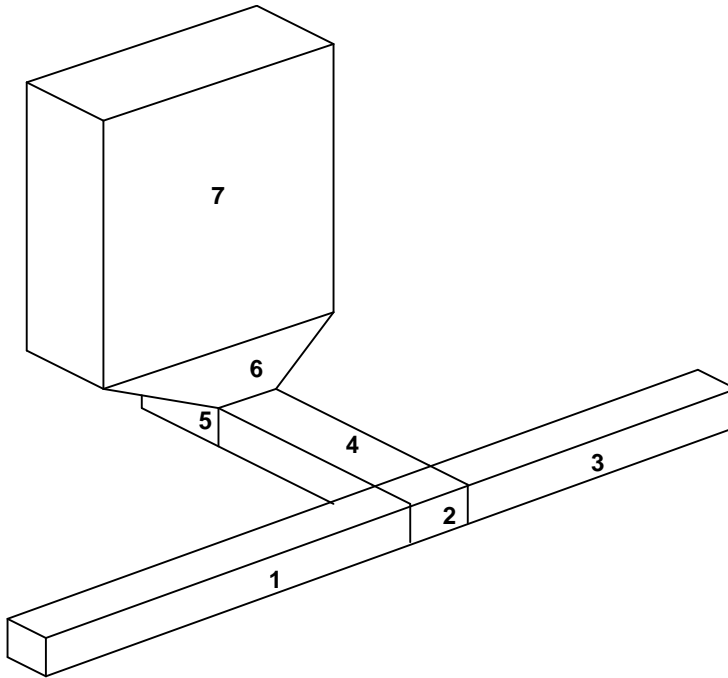

To illustrate the use of model building using three-dimensional building blocks consider the construction of a simple drawpoint configuration. This model has been assembled out of 7 blocks. Blocks 1, 2 and 3 form the extraction drift, block 4 forms the crosscut, blocks 5 and 6 represent the drawpoint, and block 7 represents the slope. Map3D recognizes and deletes the surfaces, which are common to adjacent blocks.

Many blocks can share the same block number (colour) thus permitting a group of blocks to be used to construct complex excavation shapes. An important consideration here is that, as few as possible block numbers should be used since all surfaces between blocks, which have different block numbers, will be maintained in the database.

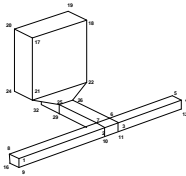

The coordinate numbers for the same drawpoint configuration are required if one wants to construct the model using the Map3D input file specification. The blocks would be numbered as follows:

```
* Block Specification
* N 'Block Name' I1,I2,I3,I4 I5,I6,I7,I8 Type,Thic,Width
1 'Block 1' 1 2 7 8 9 10 15 16 1 0 0
1 'Block 2' 2 3 6 7 10 11 14 15 1 0 0
1 'Block 3' 3 4 5 6 11 12 13 14 1 0 0
1 'Block 4' 7 6 26 25 15 14 30 29 1 0 0
2 'Block 5' 25 26 27 28 29 30 31 32 1 0 0
2 'Block 6' 21 22 23 24 25 26 27 28 1 0 0
2 'Block 7' 17 18 19 20 21 22 23 24 1 0 0
```

0

#### 4. Coordinate Specification

This section permits the user to specify coordinate locations that are used to define the corners of Blocks, DD planes and Grid planes.

**M X,Y,Z**

- 1 line of data per coordinate point must be specified.
- All parameters must appear on one line.
- All 4 parameters (**M X,Y,Z**) must be specified.
- Use N=0 to end the list of coordinates.

**M** This parameter is the coordinate number. Coordinates may be entered in any desired order.  
**X,Y,Z** These parameters represent the coordinate location. It is recommended that **X** is used for East, **Y** is used for North, and **Z** is used for elevation (positive up). The values should be specified in units of length (metres or feet).

#### 5. Material Property Specification

This section permits the user to specify the properties for each material used in the model. The properties for each material are defined in groups of three lines specifying respectively the stress state, constitutive parameters and strength parameters.

**M sa, sb, sc Dsa, Dsb, Dsc Ta,Pa,Tc Datum t/h,Dt/h**  
**Mt Ep,Er vp,vr Gn,Gs A,C 'Material Name'**  
**Mf Top,Tor UCSp,UCSr Cohesionp,Cohesionr fp,fr fi**

For a detailed description of parameters refer to [CAD > Properties > Material Properties](#)

3 lines of data per material must be specified, use  $N=0$  to end the list.

##### Material Property Specification - Line 1 - Stress State

This line of data sets up the starting stress state for material number **N**. Material number 1 is reserved for the host rock mass.

**M sa, sb, sc Dsa, Dsb, Dsc Ta,Pa,Tc Datum t/h,Dt/h**

- 1 line of numeric data per material must be specified.
- All parameters must appear on one line.
- Only the first 4 parameters (**M sa, sb, sc**) must be specified.
- For a detailed description of parameters refer to [Stress State](#)

##### Material Property Specification - Line 2 - Constitutive Properties

Constitutive properties are specified in five different ways,

**Mt=1 Ep,Er vp,vr Gn,Gs 0,0 A,C 'Material Name'**

where **Ep,Er vp,vr** represent respectively the peak and residual values for Young's modulus, Poisson's ratio

$$E = 9BS/(3B+S)$$

$$\nu = (3B-2S)/(6B+2S)$$

**Gn,Gs** represent respectively the normal and shear viscous moduli,

**A,C** represent respectively the expansion coefficient and conductivity (only used in Map3D)

Thermal-Fluid Flow).

For more details refer to

[Mohr-Coulomb in 3D FF Blocks](#)

[Mohr-Coulomb in DD Planes](#)

**Mt=2 Bp,Br Sp,Sr Gn,Gs 0,0 A,C 'Material Name'**

where **Bp,Br Sp,Sr** represent respectively the peak and residual values for the bulk and shear moduli,

$$B = E(1-2\nu)/3$$

$$S = E / [ 2(1+\nu) ]$$

**Gn,Gs** represent respectively the normal and shear viscous moduli,

**A,C** represent respectively the expansion coefficient and conductivity (only used in Map3D Thermal-Fluid Flow).

**Mt=3 Knp,Knr Ksp,Ksr Gn,Gs 0,0 A,C 'Material Name'**

where **Knp,Knr Ksp,Ksr** represent respectively the peak and residual values for the normal and shear stiffness,

$$Kn = N/Thickness$$

$$Ks = S/Thickness$$

**Gn,Gs** represent respectively the normal and shear viscous moduli,

**A,C** represent respectively the expansion coefficient and conductivity (only used in Map3D Thermal-Fluid Flow).

This material type can only be used in DD planes.

**Mt=4 Np,Nr Sp,Sr Gn,Gs B,Et A,C 'Material Name'**

where **Np,Nr Sp,Sr** represent respectively the peak and residual values for the normal and shear moduli,

**Gn,Gs** represent respectively the normal and shear viscous moduli,

**A,C** represent respectively the expansion coefficient and conductivity (only used in Map3D Thermal-Fluid Flow).

This material type can only be used in DD planes.

For more details refer to [Fault-Gouge in DD planes](#)

**Mt=5 Np,Nr Sp,Sr Gn,Gs B,Et A,C 'Material Name'**

where **Np,Nr Sp,Sr** represent respectively the peak and residual values for the normal and shear moduli,

**Gn,Gs** represent respectively the normal and shear viscous moduli,

**B,Et** represent respectively the compression limit and transition strain,

**A,C** represent respectively the expansion coefficient and conductivity (only used in Map3D Thermal-Fluid Flow).

This material type can only be used in DD planes.

For more details refer to [Backfill-Hyperbolic in DD planes](#)

For the host rock mass and non-homogeneous zones enclosed by FF elements, the value for  $Mt$  must be 1 or 2. For in-filling material placed in DD elements, any value of  $Mt$  may be used.

For elastic analysis, only the peak value is used. In non-linear analysis (fault-slip or material yielding in Map3D Non-Linear), the residual value is only used after the material yields.

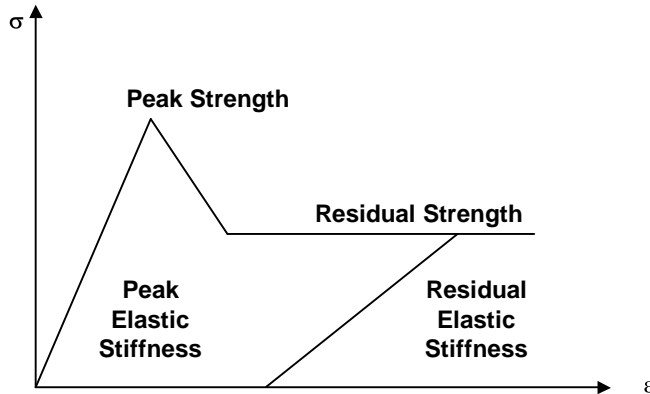

### Material Property Specification - Line 3 - Strength Parameters

1 line of numeric data per material must be specified.

All parameters must appear on one line.

All parameters must be specified if  $Mf$  is non-zero.

Strength parameters may be specified in four different ways:

#### $Mf=0$

No failure criterion used.

#### $Mf=1$ *Top,Tor UCSp,UCSr Cohesionp,Cohesionr wp,wr wi*

These parameters are defined in detail in

[Mohr-Coulomb in 3D FF Blocks](#)

[Mohr-Coulomb in DD Planes](#)

#### $Mf=2$ *Top,Tor sc p, sc r mp,mr sp,sr*

These parameters are defined in detail in

[Hoek-Brown in 3D FF Blocks](#)

#### $Mf=3$ *Top,Tor UCSp,UCSr Cohesionp,Cohesionr wp,wr*

These parameters are defined in detail in

[Drucker-Prager in 3D FF Blocks](#)

## 6. Grid Specification

This section permits the user to define the location of grid planes where analysis results will be calculated.

**N** *'Grid\_Name' I1,I2,I3,I4 I5,I6,I7,I8 0,0,0,0*

**N** *'Grid\_Name' I1,I2,I3,I4 I5,I6,I7,I8 Type Thickness,Width*

1 line of data per block must be specified.

All parameters must appear on one line.

Use **N=0** to end the list of grids.

**N** This parameter is the grid number. Grids should be numbered consecutively from 1, but may be entered in any desired order.

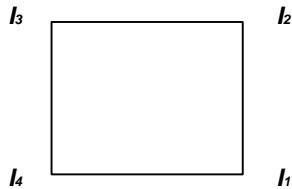

**'Grid\_Name'** This parameter permits the user to specify a descriptive name for the Grid (e.g. HW grid through 4540 stope). The program will use this name when supplying information concerning the grid. The grid name is optional, but if used it must appear in single quotation marks. Only the first 20 characters of any grid name will be used.

**I1,I2,I3,I4** These parameters represent the numbers of coordinate points that form the grid corners.

Grids are constructed using 4 sided planes. The corners can be entered in either clockwise or counter clockwise orientation.

**I5,I6,I7,I8** These parameters are not used and should be specified as zeros.

**Thickness** This parameter is not used and should be specified as zero.

**Spacing** specifies the maximum spacing permitted.

This parameter can be used to force uniform discretization on the grid. Extreme caution should be used in specifying this value since a small value can easily lead to enormous problem size.

In general this parameter should be set to zero (i.e. not used), and discretization should be left to the **AL** and **AG** parameters. These latter parameters will concentrate elements only where analysis results are requested thus optimizing the use of elements and minimizing problem size.

## 7. Mining Step Specification

This item permits the user to specify the material code to be assigned to the selected entities at each mining step.

**'Mining\_Step\_Title'**

**N, Mc**

1 line of numeric data per block specification must be specified.

All parameters must appear on one line.

2 parameters (**N,Mc**) must be specified.

The mining sequence is defined by repeatedly specifying a list of material codes. Each list is ended by using **N=0**. At each mining step, only the material codes that change need to be specified. Blocks will remain inactive until a material code is assigned.

Blocks which are never assigned a material code will be assigned a block type of 98 or 99 (i.e. inactive), these blocks will be included in the database for visualization purposed only, they will not be used in the analysis, nor will intersections be created for these surfaces.

**'Mining\_Step\_Title'** This parameter permits the user to specify a descriptive name for each mining step. The program will use this name when supplying information concerning the mining step. This is optional, but if used it must appear in single quotation marks.



**N** This parameter is the block identification number used to identify which blocks are assigned the specified material code. These may be entered in any desired order. 0 specifies the end of each mining step list.

**Mc** This parameter sets the material code for the block.

**Mc=0** surface stresses equal to zero. This is normally used to indicate stress free excavation surfaces.

**Mc=-M** A negative material number inserts (applies) the initial stress state for the material as a boundary condition. This allows you to specify any desired surface loading conditions. This is actually equivalent to inserting a material that has a zero stiffness, and thus can neither accumulate nor dissipate stress. This is normally used to indicate excavations with some internal stress state due to ground support, backfill or active pressurization.

For most analyses, the host is so stiff compared to the backfill that the amount of accumulate or dissipation of stress is insignificant. The exception would be non-linear material deformation or large closure areas.

**Mc=+M** A positive material number **M** specifies insertion of material number **M** at the initial stress state specified for that material. The material is placed with the starting stress state equal to the initial stress state for the material, then is allowed to accumulate or dissipate stress with deformation. The amount of stress change will depend on the stiffness of the inserted material. This option is used assign alternate material properties to zones defined by type 1 blocks, or to place gouge or backfill material into type 2 elements (displacement discontinuities) to simulate faults or backfilled tabular mining zones.

A simple example illustrating this feature is given in the following table:

- \* Mining Step Specification
- \* Mining Step #1
- \* N,Mc

'Block #1 is assigned properties of Ore Material #2'

```
1 2
0
```

'Block #1 is excavated'

```
1 0
0
```

'Block #1 is backfilled with Material #3'

```
1 3
0
```

### 5.3.11 File > Open > Recent Directories

Each time you open a model file or restart file its working directory is saved for quick access at a later session. To reopen one of these directories just pick it from the list.

Related Topics:

[File > Open > Recent Files](#)

### 5.3.12 File > Open > Merge Geometries

If this option is checked, as the new model file or construction line file is loaded, the geometric data is merged with the current geometric data.

If this option is not checked, as the new model file or construction line file is loaded, the geometric data will replace/overwrite the current geometric data.

This allows you to construct your model or construction line database in small pieces and merge them as required.

Related Topics:

[File > Open > Merge Materials.](#)

### 5.3.13 File > Model File Formats

Models can be loaded from several file types:

[Map3D-INP](#) format is an editable ASCII data file with the extension ".INP". This is the recommended Map3D model format. All Map3D functionality is supported with this format.

[AutoCAD-DXF](#) format is a popular drawing exchange file with the extension ".DXF". This format is useful for exchanging model data with other CAD software.

[Point file format](#) is a universal ASCII data file with the extension ".PNT". This format is useful for exchanging raw model data with other CAD software.

Models from different files can be merged. The merge option

[File > Open > Merge](#)

appears at the bottom of the open file dialogue box.

Related Topics:

[File > Open](#)

[File > Save As](#)

## 5.4 Materials

### 5.4.1 Materials > Mohr-Coulomb in 3D FF Blocks

Mohr-Coulomb material can be used to describe non-linear response in 3D FF blocks in Map3D Non-Linear. It can also be used as a failure criterion for elastic analyses in Map3D Fault-Slip.

	Peak	Residual
Tension Cutoff	0	0
UCS (rockmass)	60	60
Cohesion	17.321	17.321
Friction Angle	30	30
Dilatation Angle	0	
Young's Modulus	60000	60000
Poisson's Ratio	0.250	0.250
Standard Dev	0	
Viscous Mod (Gr)	0	
Viscous Mod (Gs)	0	
Expansion Coef	1	
Conductivity	1	

**Material Name** - specifies a descriptive name for the material.

**Material #** - specifies the material number.

- Material #1 is reserved for the host material.
- Other material numbers are used to define alternate material zones such as ore, fault gouge, backfill etc.

**Material Type** - specifies the material type ([Mohr-Coulomb](#), [Hoek-Brown](#), [Drucker-Prager](#), [Fault-Gouge](#), [Hyperbolic-Backfill](#), [Quadratic-Backfill](#), [Equilibrated-Gouge](#), [Yielding-Pillar](#) or none).

- **Mohr-Coulomb** - defines the failure envelope as a straight line.
- For 3D FF blocks the Mohr-Coulomb criterion defines strength in terms of principal stresses as follows:

### Mohr-Coulomb in 3D FF blocks

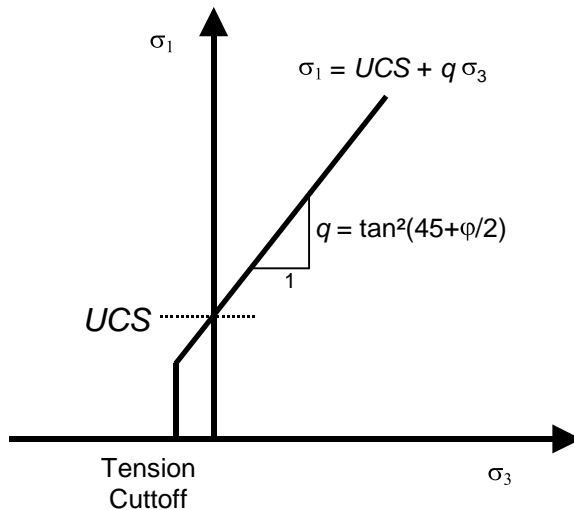

- **Tension cutoff and UCS** - are specified in units of stress (MPa or psi).
- **Friction angle and dilation angle** are specified in degrees.
- **Cohesion** is related to **UCS** and friction angle by the relationship  $UCS = 2 Coh \tan(45 + \phi/2)$ . If Cohesion is specified then **UCS** is determined from this relation.
- Peak values of these parameters are used up until failure. After yielding, the residual values are used to provide a strain softening response.
- Residual values are ignored in elastic analyses.

**Young's Modulus and Poisson's Ratio** - specify Young's Modulus in units of stress (MPa or psi).

- Peak values of these parameters are used up until failure.
- After yielding, the residual values are used. Residual values are ignored in elastic analyses.

**Standard Deviation** - specify standard deviation in units of stress (MPa or psi).

- This parameter describes the uncertainty you have in the strength parameters.
- This parameter is only used for plotting the probability of shear failure [Plot > Strength Factors > Rockmass Probability N-distribution](#).

**Viscous Modulus ( $G_n$  and  $G_s$ )** - These parameters are used only in non-linear analyses (3D FF blocks in Map3D Non-Linear and DD planes in Map3D Fault-Slip). For 3D FF blocks only  **$G_s$**  is used.

- The viscous modulus describes the creep response. where the creep resistance is determined as the creep coefficient  **$C$** , times the plastic strain rate. Note that the user must select both the creep coefficient  **$C$** , and the time step size  $\Delta t$ , then specify the quotient of these as the viscous modulus  **$G$** .
- Specify the viscous modulus in units of stress (MPa or psi).

**Expansion Coefficient and Conductivity** are only used in [Map3D Thermal-Fluid Flow](#).

- Map3D Thermal-Fluid Flow can be used to simultaneously solve steady state heat/fluid flow coupled to the stress analysis.

**Elastic only** - when checked this material will respond elastically only, i.e. strength parameters will not be used.

- This can be used to define zones with different elastic properties and/or initial stress states. This

could include for example stiff dykes, soft ore zones, backfill or support elements.

**Elasto-Plastic** - when checked this material will respond elasto-visco-plastically, i.e. the strength parameters will be used as a flow rule.

- This can be used to define zones with both different elastic properties and strength parameters.
- Note that in [Map3D Fault-Slip](#), only DD elements (i.e. fault gouge) are permitted to respond non-linearly.
- In [Map3D Non-Linear](#) the 3D rock mass can also yield plastically.

**Inactive** - when checked this material will not be used in the stress analysis and hence will not affect the predicted stresses, strains or displacements.

- This can be used to define zones with different strength parameters to be used when generating contours of strength factors.

**User Defined** - allows specification of user defined parameters to be used in contouring.

- Different parameters are defined for each material number.
- These parameters are used with [User Plot > Stress > User](#)
- This can be used to define zones with different strength parameters to be used when generating contours of strength factors.

**Dump to File** - allows you to dump all material property data to a file for viewing in Notepad or Excel.

**Copy from material** - allows you to copy the material properties from one material number to another. All properties including the stress state are copied.

**Stress State** - specifies the initial (far field) stress state for the material.

- Most materials are inserted into blocks with the same (far field) stress state.
- Materials such as props or backfill are placed at near zero initial stresses.

In elastic analysis the principal stresses are normally used with the Mohr-Coulomb or Hoek-Brown strength criterion to estimate the amount of damage due to over-stressing. One can expect that more excess stress in an elastic analysis would in general correlate with increased amounts of plastic strain in a non-linear analysis. Since none of the parameters have any orientation sensitivity, this criterion is representative for homogeneous rock mass stability.

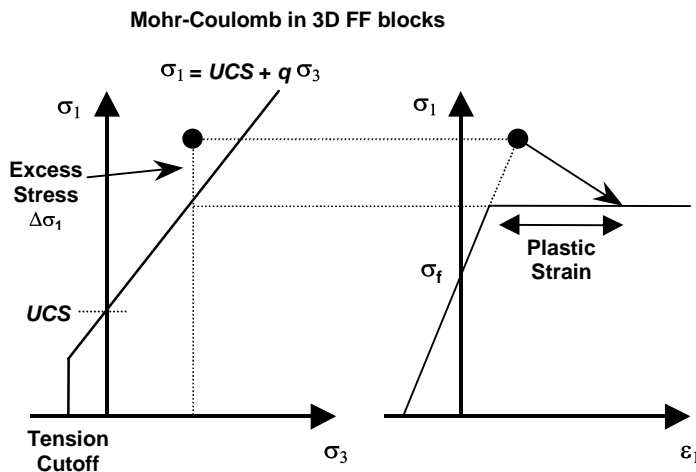

Over-stressing can be presented in several ways including:

[User Plot > Strength Factors > dS1](#) - Excess Stress

 [Plot > Strength Factors > dTmax](#) - Excess Stress

  [Plot > Strength Factor > SF-A](#) - Strength/Stress

  [Plot > Strength Factor > SF-B](#) - Strength/Stress

  [Plot > Strength Factors > SF-C](#) - Strength/Stress

By contrast, in non-linear analysis the stresses can never exceed the strength unless some creep is used (in this latter case, viscous creep can allow stress states above the failure criterion, thus indicating a lack of static equilibrium). Hence for non-linear analysis one normally directly considers the plastic strain or the plastic strain rate predicted by the model as an indicator of damage.

In 3D FF blocks, the elastic strains are determined from the stresses by

$$\begin{aligned}\sigma_{xx} &= \sigma_{xf} + [(1-\nu) \epsilon_{xx\text{elastic}} + \nu (\epsilon_{yy\text{elastic}} + \epsilon_{zz\text{elastic}})] E / [(1+\nu) (1-2\nu)] \\ \sigma_{yy} &= \sigma_{yf} + [(1-\nu) \epsilon_{yy\text{elastic}} + \nu (\epsilon_{zz\text{elastic}} + \epsilon_{xx\text{elastic}})] E / [(1+\nu) (1-2\nu)] \\ \sigma_{zz} &= \sigma_{zf} + [(1-\nu) \epsilon_{zz\text{elastic}} + \nu (\epsilon_{xx\text{elastic}} + \epsilon_{yy\text{elastic}})] E / [(1+\nu) (1-2\nu)] \\ \tau_{xy} &= \tau_{xf} + \epsilon_{xy\text{elastic}} E / (1+\nu) \\ \tau_{yz} &= \tau_{yf} + \epsilon_{yz\text{elastic}} E / (1+\nu) \\ \tau_{xz} &= \tau_{zf} + \epsilon_{xz\text{elastic}} E / (1+\nu)\end{aligned}$$

where  $E$  and  $\nu$  represent respectively Young's modulus and Poisson's ratio, and  $\sigma_f$  and  $\tau_f$  represent the initial (pre-mining) stress state

In Map3D Non-Linear, if the stress goes above the strength, the plastic strain can be determined by limiting the stress

$$\sigma_1 - \sigma_1^\circ - C \Delta \epsilon_{1\text{plastic}} / \Delta t = UCS + q (\sigma_3 - \sigma_3^\circ - C \Delta \epsilon_{3\text{plastic}} / \Delta t)$$

where

$$\begin{aligned}\sigma_1^\circ &= [(1-\nu) \epsilon_{1\text{plastic}} + \nu (\epsilon_{2\text{plastic}} + \epsilon_{3\text{plastic}})] E / [(1+\nu) (1-2\nu)] \\ \sigma_2^\circ &= [(1-\nu) \epsilon_{2\text{plastic}} + \nu (\epsilon_{3\text{plastic}} + \epsilon_{1\text{plastic}})] E / [(1+\nu) (1-2\nu)] \\ \sigma_3^\circ &= [(1-\nu) \epsilon_{3\text{plastic}} + \nu (\epsilon_{1\text{plastic}} + \epsilon_{2\text{plastic}})] E / [(1+\nu) (1-2\nu)]\end{aligned}$$

The accumulated plastic strain  $\epsilon_{\text{plastic}}$ , is determined as the sum of the plastic creep increments  $\Delta \epsilon_{\text{plastic}}$ , for all creep steps.

If the stress goes below the tension cutoff, the plastic strain can be determined by limiting the stress

$$\sigma_3 - \sigma_3^\circ - C \Delta \epsilon_{3\text{plastic}} / \Delta t = T_o$$

The plastic volumetric strain can also have a dilation component

$$\epsilon_{\text{volume}} = (\epsilon_{1\text{plastic}} + \epsilon_{2\text{plastic}} + \epsilon_{3\text{plastic}}) = \tan(\text{dilation angle}) \epsilon_{1\text{plastic}}$$

The total strain is equal to the sum of the elastic and plastic parts.

The creep response is simulated using a linear (Bingham) creep model.

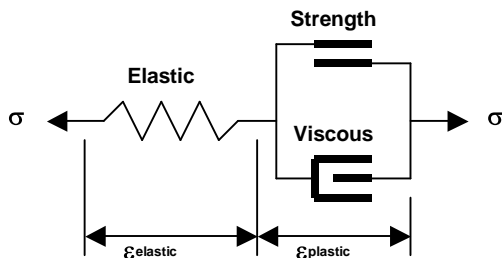

At each creep step the stress state on all yielding elements (elements where the stress exceeds the strength) is calculated as the strength plus the creep resistance

$$\sigma = \text{Strength} + C \Delta \epsilon_{\text{plastic}} / \Delta t$$
$$C = G \Delta t$$

where the creep resistance is determined as the creep coefficient  $C$ , times the plastic strain rate. Note that the user must select both the creep coefficient  $C$ , and the time step size  $\Delta t$ , then specify the quotient of these as the viscous modulus  $G$ . The creep resistance can be used simply as a technique for damping the non-linear deformations or for real time dependent creep simulation

[Analysis > Options > Creep](#)

The strains can be presented in several ways including:

 [Plot > Strain > Value > Elastic](#)

 [Plot > Strain > Value > Plastic](#)

 [Plot > Strain > Value > Total](#)

 [Plot > Strain > E1](#) - Major principal strain

 [Plot > Strain > E2](#) - Intermediate principal strain

 [Plot > Strain > E3](#) - Minor principal strain

 [Plot > Strain > Emax](#) - Maximum shear strain

 [Plot > Strain > Evolume](#) - Volumetric shear strain

Related Topics:

[Hoek-Brown in 3D FF blocks](#)

[Drucker-Prager in 3D FF blocks](#)

## 5.4.2 Materials > Hoek-Brown in 3D FF Blocks

Hoek-Brown material can only be used as a failure criterion for elastic analyses in Map3D Fault-Slip.

	Peak	Residual
Tension Cutoff	0	0
Sigma:C (lab scale)	60	60
m Hoek-Brown	9.600	9.600
s Hoek-Brown	1	1
Young's Modulus	60000	60000
Poisson's Ratio	0.250	0.250
Standard Dev	0	
Viscous Mod (Gn)	0	
Viscous Mod (Gs)	0	
Expansion Coef	1	
Conductivity	1	

**Material Name** - specifies a descriptive name for the material.

**Material #** - specifies the material number.

- Material #1 is reserved for the host material.
- Other material numbers are used to define alternate material zones such as ore, fault gouge, backfill etc.

**Material Type** - specifies the material type ([Mohr-Coulomb](#), [Hoek-Brown](#), [Drucker-Prager](#), [Fault-Gouge](#), [Hyperbolic-Backfill](#), [Quadratic-Backfill](#), [Equilibrated-Gouge](#), [Yielding-Pillar](#) or none).

- **Hoek-Brown** - defines the failure envelope as a curved line.
- For 3D FF blocks the Hoek-Brown criterion defines strength in terms of principal stresses as follows:

### Hoek-Brown in 3D FF blocks

$$\sigma_1 = \sigma_3 + (m \sigma_c \sigma_3 + s \sigma_c^2)^{1/2}$$

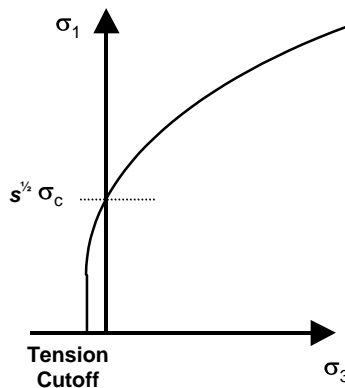

- **Tension cutoff** and  $\sigma_c$  are specified in units of stress (MPa or psi).
- Only the peak values are used.



[Young's Modulus and Poisson's Ratio](#) - specify Young's Modulus in units of stress (MPa or psi).

- Only the peak values are used.

[Standard Deviation](#) - specify standard deviation in units of stress (MPa or psi).

- This parameter describes the uncertainty you have in the strength parameters.
- This parameter is only used for plotting the probability of shear failure [Plot > Strength Factors > Rockmass Probability N-distribution](#).

[Viscous Modulus \(Gn and Gs\)](#) - These parameters are not used for the Hoek-Brown material.

[Expansion Coefficient and Conductivity](#) are only used in [Map3D Thermal-Fluid Flow](#). Map3D Thermal-Fluid Flow can be used to simultaneously solve steady state heat/fluid flow coupled to the stress analysis.

[Elastic only](#) - when checked this material will respond elastically only, i.e. strength parameters will not be used.

- This can be used to define zones with different elastic properties and/or initial stress states. This could include for example stiff dykes, soft ore zones, backfill or support elements.

[Elasto-Plastic](#) - when checked this material will respond elasto-visco-plastically, i.e. the strength parameters will be used as a flow rule.

- This can be used to define zones with both different elastic properties and strength parameters.
- Note that in [Map3D Fault-Slip](#), only DD elements (i.e. fault gouge) are permitted to respond non-linearly.
- In [Map3D Non-Linear](#) the 3D rock mass can also yield plastically.
- Yielding of Hoek-Brown materials is not supported at this time.

[Inactive](#) - when checked this material will not be used in the stress analysis and hence will not affect the predicted stresses, strains or displacements.

- This can be used to define zones with different strength parameters to be used when generating contours of strength factors.

[User Defined](#) - allows specification of user defined parameters to be used in contouring.

- Different parameters are defined for each material number.
- These parameters are used with  [Plot > Stress > User](#)
- This can be used to define zones with different strength parameters to be used when generating contours of strength factors.

[Dump to File](#) - allows you to dump all material property data to a file for viewing in Notepad or Excel.

[Copy from material](#) - allows you to copy the material properties from one material number to another. All properties including the stress state are copied.

[Stress State](#) - specifies the initial (far field) stress state for the material.

- Most materials are inserted into blocks with the same (far field) stress state.
- Materials such as props or backfill are placed at near zero initial stresses.

Related Topics:

[Mohr-Coulomb in 3D FF blocks](#)

[Drucker-Prager in 3D FF blocks](#)

### 5.4.3 Materials > Drucker-Prager in 3D FF Blocks

Hoek-Brown material can only be used as a failure criterion for elastic analyses in Map3D Fault-Slip.

	Peak	Residual
Tension Cutoff	0	0
UCS (rockmass)	60	60
Friction Angle	30	30
Young's Modulus	60000	60000
Poisson's Ratio	0.250	0.250
Standard Dev	0	
Viscous Mod (Gr)	0	
Viscous Mod (Gs)	0	
Expansion Coef	1	
Conductivity	1	

Material Name: Host Material #1  
 Material #: 1  
 Material Type: Drucker-Prager (FF)  
 Behavior:  Elastic only,  Elasto-Plastic,  Inactive  
 Parameters:  User Defined Parameters,  Dump to File

**Material Name** - specifies a descriptive name for the material.

**Material #** - specifies the material number.

- Material #1 is reserved for the host material.
- Other material numbers are used to define alternate material zones such as ore, fault gouge, backfill etc.

**Material Type** - specifies the material type ([Mohr-Coulomb](#), [Hoek-Brown](#), [Drucker-Prager](#), [Fault-Gouge](#), [Hyperbolic-Backfill](#), [Quadratic-Backfill](#), [Equilibrated-Gouge](#), [Yielding-Pillar](#) or none).

- **Drucker-Prager** - defines the failure envelope as a straight line.
- For 3D FF blocks the Drucker-Prager criterion defines strength in terms of principal stresses as follows:

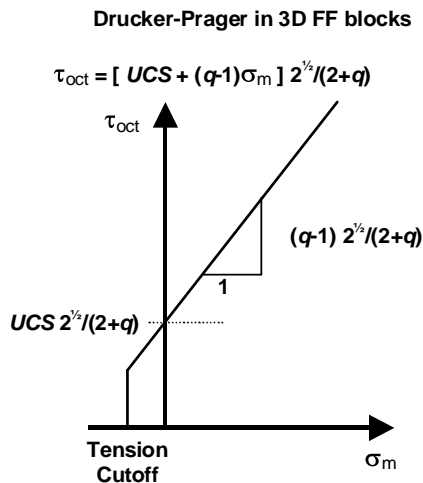

$$\tau_{oct} = 1/3 [(\sigma_1 - \sigma_2)^2 + (\sigma_2 - \sigma_3)^2 + (\sigma_3 - \sigma_1)^2]^{1/2}$$

$$\sigma_m = 1/3 (\sigma_1 + \sigma_2 + \sigma_3)$$

$$q = \tan^2(45 + 1/2 \phi)$$

- Note that the strength parameters have been chosen so that the criterion simplifies to the [Mohr-Coulomb](#) criterion when  $\sigma_2$  equals  $\sigma_3$ .
- [Tension cutoff and UCS](#) - are specified in units of stress (MPa or psi).
- [Friction angle and dilation angle](#) are specified in degrees.
- [Cohesion](#) is not used for 3D FF blocks.
- Only the peak values are used.

[Young's Modulus and Poisson's Ratio](#) - specify Young's Modulus in units of stress (MPa or psi).

- Only the peak values are used.

[Standard Deviation](#) - specify standard deviation in units of stress (MPa or psi).

- This parameter describes the uncertainty you have in the strength parameters.
- This parameter is only used for plotting the probability of shear failure [Plot > Strength Factors > Rockmass Probability N-distribution](#).

[Viscous Modulus \(Gn and Gs\)](#) - These parameters are not used for the Drucker-Prager material.

[Expansion Coefficient and Conductivity](#) are only used in [Map3D Thermal-Fluid Flow](#). Map3D Thermal-Fluid Flow can be used to simultaneously solve steady state heat/fluid flow coupled to the stress analysis.

[Elastic only](#) - when checked this material will respond elastically only, i.e. strength parameters will not be used.

- This can be used to define zones with different elastic properties and/or initial stress states. This could include for example stiff dykes, soft ore zones, backfill or support elements.

[Elasto-Plastic](#) - when checked this material will respond elasto-visco-plastically, i.e. the strength parameters will be used as a flow rule.

- This can be used to define zones with both different elastic properties and strength parameters.
- Note that in [Map3D Fault-Slip](#), only DD elements (i.e. fault gouge) are permitted to respond non-linearly.
- In [Map3D Non-Linear](#) the 3D rock mass can also yield plastically.
- Yielding of Drucker-Prager materials is not supported at this time.

[Inactive](#) - when checked this material will not be used in the stress analysis and hence will not affect the predicted stresses, strains or displacements.

- This can be used to define zones with different strength parameters to be used when generating contours of strength factors.

[User Defined](#) - allows specification of user defined parameters to be used in contouring.

- Different parameters are defined for each material number.
- These parameters are used with [User](#) [Plot > Stress > User](#)
- This can be used to define zones with different strength parameters to be used when generating contours of strength factors.

[Dump to File](#) - allows you to dump all material property data to a file for viewing in Notepad or Excel.

[Copy from material](#) - allows you to copy the material properties from one material number to another.

- All properties including the stress state are copied.

[Stress State](#) - specifies the initial (far field) stress state for the material.

- Most materials are inserted into blocks with the same (far field) stress state.
- Materials such as props or backfill are placed at near zero initial stresses.

Related Topics:

[Mohr-Coulomb in 3D FF blocks](#)

[Hoek-Brown in 3D FF blocks](#)

#### 5.4.4 Materials > Fault-Gouge in DD Planes

Fault-Gouge material can be used to describe non-linear response in DD planes in both Map3D Fault-Slip and Map3D Non-Linear.

The screenshot shows the 'Material Properties' dialog box for a material named 'Material #2'. The material type is 'Fault Gouge (DD)'. The dialog is divided into 'Peak' and 'Residual' columns. The 'Elastic only' option is unselected, and 'Elasto-Plastic' is selected. The 'User Defined Parameters' section is also visible.

	Peak	Residual
Tension Cutoff	0	0
Cohesion	10	10
Friction Angle	30	30
Dilation Angle	0	
Normal Modulus	40000	40000
Shear Modulus	24000	24000
Standard Dev	0	
Viscous Mod (Gn)	0	
Viscous Mod (Gs)	0	
Expansion Coef	1	
Conductivity	1	

Material Name: Material #2  
Material #: 2  
Material Type: Fault Gouge (DD)  
Material Properties: Elastic only, Elasto-Plastic, Inactive, User Defined Parameters, Dump to File  
Buttons: Copy from mat..., Stress State, Close

**Material Name** - specifies a descriptive name for the material.

**Material #** - specifies the material number.

- Material #1 is reserved for the host material.
- Other material numbers are used to define alternate material zones such as ore, fault gouge, backfill etc.

**Material Type** - specifies the material type ([Mohr-Coulomb](#), [Hoek-Brown](#), [Drucker-Prager](#), [Fault-Gouge](#), [Hyperbolic-Backfill](#), [Quadratic-Backfill](#), [Equilibrated-Gouge](#), [Yielding-Pillar](#) or none).

- **Fault-Gouge** - defines the failure envelope as a straight line in the same as [Mohr-Coulomb in DD planes](#) but without *UCS*.
- Strength is defined in terms of in-plane shear and normal stresses as follows:

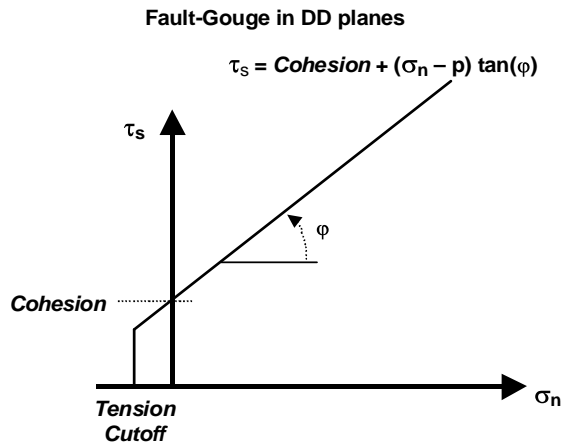

- **Tension Cutoff and Cohesion** are specified in units of stress (MPa or psi).
- **Friction angle and dilation angle** are specified in degrees.
- **Cohesion and friction angle** define the shear response.
- The **tension cutoff** defines the response in the direction normal to the shear plane.
- Peak values of these parameters are used up until failure.
- After yielding, the residual values are used to provide a strain softening response.
- Residual values are ignored in elastic analyses.
- If fluid pressure is specified as part of the [Stress State](#), the effective normal stress ( $\sigma_n - p$ ) is used (here  $p$  is the fluid pressure).

**Normal and Shear Modulus** - specify moduli in units of stress (MPa or psi).

- In DD planes the shear and normal stresses acting on the surfaces of the element are related to the elastic portion of the shear displacement (ride) and normal displacement (closure) through the shear and normal moduli.
- Peak values of these parameters are used up until failure.
- After yielding, the residual values are used.

**Standard Deviation** - specify standard deviation in units of stress (MPa or psi).

- This parameter describes the uncertainty you have in the strength parameters.
- This parameter is only used for plotting the probability of shear failure [Plot > Strength Factors > In-Plane Probability N-distribution](#).

**Viscous Modulus ( $G_n$  and  $G_s$ )** - These parameters are used only in non-linear analyses (3D FF blocks in Map3D Non-Linear and DD planes in Map3D Fault-Slip).

- The viscous modulus describes the creep response. where the creep resistance is determined as the creep coefficient  $C$ , times the plastic strain rate.
- Note that the user must select both the creep coefficient  $C$ , and the time step size  $\Delta t$ , then specify the quotient of these as the viscous modulus  $G$ .
- Specify the viscous modulus in units of stress (MPa or psi).

**Expansion Coefficient and Conductivity** are only used in [Map3D Thermal-Fluid Flow](#).

- Map3D Thermal-Fluid Flow can be used to simultaneously solve steady state heat/fluid flow coupled to the stress analysis.

**Elastic only** - when checked this material will respond elastically only, i.e. strength parameters will not be used.

- This can be used to define zones with different elastic properties and/or initial stress states. This

could include for example stiff dykes, soft ore zones, backfill or support elements.

**Elasto-Plastic** - when checked this material will respond elasto-visco-plastically, i.e. the strength parameters will be used as a flow rule.

- This can be used to define zones with both different elastic properties and strength parameters.
- Note that in [Map3D Fault-Slip](#), only DD elements (i.e. fault gouge) are permitted to respond non-linearly.
- In [Map3D Non-Linear](#) the 3D rock mass can also yield plastically.

**Inactive** - when checked this material will not be used in the stress analysis and hence will not affect the predicted stresses, strains or displacements.

- This can be used to define zones with different strength parameters to be used when generating contours of strength factors.

**User Defined** - allows specification of user defined parameters to be used in contouring.

- Different parameters are defined for each material number.
- These parameters are used with [User Plot > Stress > User](#)
- This can be used to define zones with different strength parameters to be used when generating contours of strength factors.

**Dump to File** - allows you to dump all material property data to a file for viewing in Notepad or Excel.

**Copy from material** allows you to copy the material properties from one material number to another. All properties including the stress state are copied.

**Stress State** - specifies the initial (far field) stress state for the material.

- Most materials are inserted into blocks with the same (far field) stress state.
- Materials such as props or backfill are placed at near zero initial stresses.

In elastic analysis the shear and normal stresses in the plane of weakness (on a fault, joint set or bedding plane) are normally used with the Mohr-Coulomb strength criterion to estimate the amount of damage due to over-stressing. One can expect that more excess stress in an elastic analysis would in general correlate with increased amounts of plastic strain (slip) in a non-linear analysis. Since these parameters are orientation dependant, this criterion is representative for anisotropic rock mass stability.

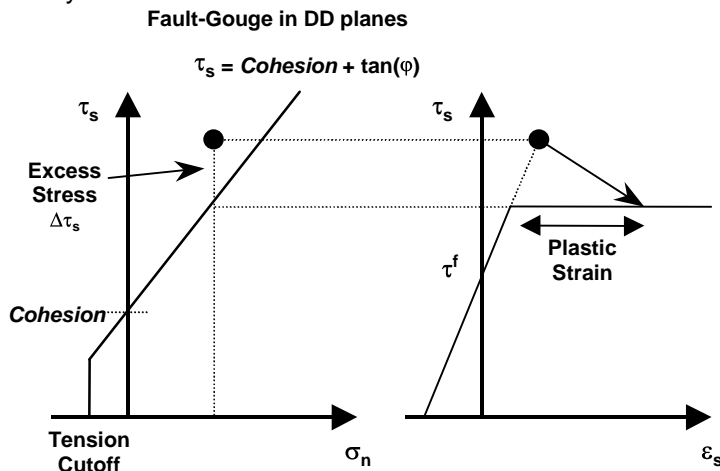

Over-stressing can be presented in several ways including:

[Plot > Strength Factors > dTip](#) In-Plane excess shear stress

 [Plot > Strength Factors > dTub](#) Ubiquitous-plane excess shear stress

  [Plot > Strength Factors > SF-ip](#) Strength/Stress

  [Plot > Strength Factors > SF-ub](#) Strength/Stress

By contrast, in non-linear analysis the stresses can never exceed the strength unless some creep is used (in this latter case, viscous creep can allow stress states above the failure criterion, thus indicating a lack of static equilibrium). Hence for non-linear analysis one normally directly considers the plastic strain or the plastic strain rate predicted by the model as an indicator of damage.

In DD planes, the elastic strains are determined from the stresses by

$$\tau_s = \tau_f + \textit{Shear Modulus} \epsilon_{\text{elastic}}$$

$$\sigma_n = \sigma_f + \textit{Normal Modulus} \epsilon_{\text{elastic}}$$

where *Shear Modulus* and *Normal Modulus* represent respectively the elastic moduli of the gouge material in the shear and normal directions, and  $\tau_f$  and  $\sigma_f$  represent the initial stress state in the shear and normal directions, and

$$\epsilon_{\text{elastic}} = \delta_{\text{elastic}} / \textit{Thickness}$$

$$\epsilon_{\text{elastic}} = \delta_{\text{elastic}} / \textit{Thickness}$$

where  $\delta_{\text{elastic}}$  and  $\delta_{\text{elastic}}$  represent respectively the elastic component of the shear displacement (ride) and normal displacement (closure) and *Thickness* represents the DD plane thickness (i.e. fault gouge, seam width, mining width or pillar height). The DD plane thickness is set using

 [CAD > Build > DDLoop](#)

and can be modified using

 [CAD > Edit > Entity Properties](#)

In DD elements, if the shear stress goes above the strength, the plastic strain can be determined by limiting the stress

$$\tau_s - \tau_s^\circ - C \Delta \epsilon_{\text{plastic}} / \Delta t = \textit{Cohesion} + \tan(\varphi) (\sigma_n - \sigma_n^\circ - C \Delta \epsilon_{\text{plastic}} / \Delta t)$$

where

$$\tau_s^\circ = \textit{Shear Modulus} \epsilon_{\text{plastic}}$$

$$\sigma_n^\circ = \textit{Normal Modulus} \epsilon_{\text{plastic}}$$

The accumulated plastic strain  $\epsilon_{\text{plastic}}$ , is determined as the sum of the plastic creep increments  $\Delta \epsilon_{\text{plastic}}$ , for all creep steps.

If the normal stress goes below the tension cutoff, the plastic strain can be determined by limiting the stress

$$\sigma_n - \sigma_n^\circ - C \Delta \epsilon_{\text{plastic}} / \Delta t = T_o$$

In the case of shear failure, the plastic normal strain can also have a dilation component

$$\epsilon_{\text{plastic}} = \tan(\textit{dilation angle}) \epsilon_{\text{plastic}}$$

The total strain is equal to the sum of the elastic and plastic parts.

The creep response is simulated using a linear (Bingham) creep model.

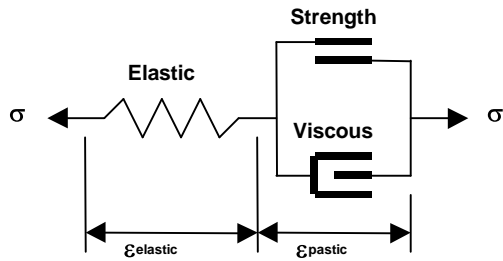

At each creep step the stress state on all yielding elements (elements where the stress exceeds the strength) is calculated as the strength plus the creep resistance

$$\text{Strength} + C \Delta \epsilon_{\text{plastic}} / \Delta t$$

$$C = G \Delta t$$

where the creep resistance is determined as the creep coefficient  $C$ , times the plastic strain rate. Note that the user must select both the creep coefficient  $C$ , and the time step size  $\Delta t$ , then specify the quotient of these as the viscous modulus  $G$ . The creep resistance can be used simply as a technique for damping the non-linear deformations or for real time dependent creep simulation

[Analysis > Options > Creep](#)

The strains, shear displacement (ride) and normal displacement (closure) can be presented in several ways including:

$\epsilon^{\text{el}}$  [Plot > Surface > Value > Elastic](#)

$\epsilon^{\text{pl}}$  [Plot > Surface > Value > Plastic](#)

$\epsilon^{\text{tot}}$  [Plot > Surface > Value > Total](#)

$\epsilon_1$  [Plot > Strain > E1](#) - Major principal strain

$\epsilon_s$  [Plot > Surface > Es](#) Shear Strain

$\epsilon_n$  [Plot > Surface > En](#) Normal Strain

$\delta_s$  [Plot > Surface > ds](#) Shear Displacement (Ride)

$\delta_n$  [Plot > Surface > dn](#) Normal Displacement (Closure)

Also of interest is the plastic creep increment  $\Delta \epsilon_{\text{plastic}}$ , the contribution to the shear resistance from the viscous element

$$\Delta \tau_s = C \Delta \epsilon_{\text{plastic}} / \Delta t$$

$\Delta \epsilon_s$  [Plot > Surface > dEs](#) Incremental Shear Strain

$\Delta \tau_s$  [Plot > Surface > dTs](#) Excess Shear Stress

Related Topics:

[Mohr-Coulomb in DD planes](#)

[Backfill-Hyperbolic in DD planes](#)



## 5.4.5 Materials > Hyperbolic-Backfill in DD Planes

Hyperbolic-Backfill material can be used to describe non-linear response in DD planes in both Map3D Fault-Slip, Map3D Non-Linear and Map3D Visco-Plastic.

Material Properties	
Material Name	Material #2
Material #	2
Material Type	Hyperbolic-Backfill (DD)
	Peak      Residual
Tension Cutoff	0      0
Cohesion	10      10
Friction Angle	30      30
B.et	1      0
Normal Modulus	40000      40000
Shear Modulus	24000      24000
Standard Dev	0 <input type="radio"/> Elastic only
Viscous Mod (Gn)	0 <input checked="" type="radio"/> Elasto-Plastic
Viscous Mod (Gs)	0 <input type="radio"/> Inactive
Expansion Coef	1      User Defined Parameters
Conductivity	1      Dump to File
<input type="button" value="Copy from matl..."/> <input type="button" value="Stress State"/> <input type="button" value="Close"/>	

**Material Name** - specifies a descriptive name for the material.

**Material #** - specifies the material number.

- Material #1 is reserved for the host material.
- Other material numbers are used to define alternate material zones such as ore, fault gouge, backfill etc.

**Material Type** - specifies the material type ([Mohr-Coulomb](#), [Hoek-Brown](#), [Drucker-Prager](#), [Fault-Gouge](#), [Hyperbolic-Backfill](#), [Quadratic-Backfill](#), [Equilibrated-Gouge](#), [Yielding-Pillar](#) or none).

- **Hyperbolic-Backfill** - defines the failure envelope as a straight line in the same as [Mohr-Coulomb in DD planes](#) but without *UCS*.
- Strength is defined in terms of in-plane shear and normal stresses as follows:

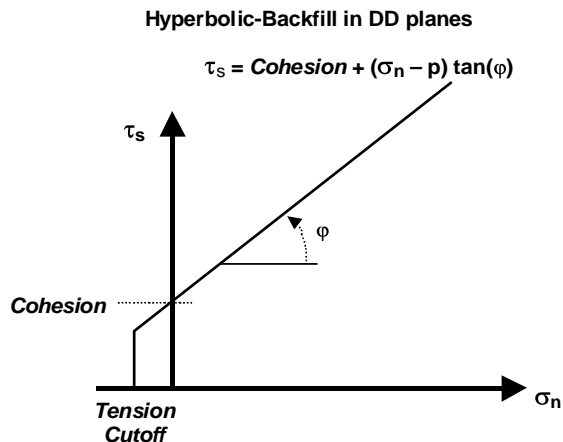

- **Tension Cutoff and Cohesion** are specified in units of stress (MPa or psi).

- Friction angle and dilation angle are specified in degrees.
- Cohesion and friction angle define the shear response.
- The tension cutoff defines the response in the direction normal to the shear plane.
- Peak values of these parameters are used up until failure.
- After yielding, the residual values are used to provide a strain softening response.
- Residual values are ignored in elastic analyses.
- If fluid pressure is specified as part of the [Stress State](#), the effective normal stress ( $\sigma_n - p$ ) is used (here  $p$  is the fluid pressure).

**B, et** - for DD planes the Hyperbolic-Backfill criterion defines the hyperbolic normal response as follows:

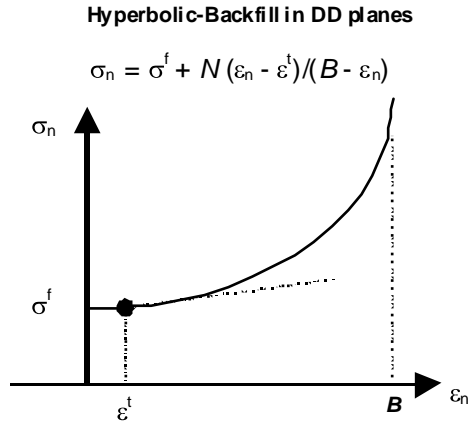

- The normal stress varies according to the hyperbolic relation.
- As the strain approaches the value  $B$  the normal stress rapidly become infinite thus limited the amount of normal displacement (closure) that can take place.

**Normal and Shear Modulus** - specify moduli in units of stress (MPa or psi).

- The normal response is defined above.  $N$  represents the value of the normal stress (for  $\sigma^f=0$ ) at  $\varepsilon_n = \frac{1}{2}(\varepsilon^t + B)$ .
- The shear stresses acting on the surfaces of the elements are related to the elastic portion of the shear displacement (ride) through the shear modulus as in the [Fault-Gouge](#) model.

**Standard Deviation** - specify standard deviation in units of stress (MPa or psi).

- This parameter describes the uncertainty you have in the strength parameters.
- This parameter is only used for plotting the probability of shear failure [Plot > Strength Factors > In-Plane Probability N-distribution](#).

**Viscous Modulus ( $G_n$  and  $G_s$ )** - These parameters are used only in non-linear analyses (3D FF blocks in Map3D Non-Linear and DD planes in Map3D Fault-Slip).

- The viscous modulus describes the creep response. where the creep resistance is determined as the creep coefficient  $C$ , times the plastic strain rate. Note that the user must select both the creep coefficient  $C$ , and the time step size  $\Delta t$ , then specify the quotient of these as the viscous modulus  $G$ .
- $G_n$  is not used in the hyperbolic model.
- Specify the viscous modulus in units of stress (MPa or psi).

**Expansion Coefficient and Conductivity** are only used in [Map3D Thermal-Fluid Flow](#).

- Map3D Thermal-Fluid Flow can be used to simultaneously solve steady state heat/fluid flow coupled to the stress analysis.

**Elastic only** - when checked this material will respond elastically only, i.e. strength parameters will not be used.

- This can be used to define zones with different elastic properties and/or initial stress states. This could include for example stiff dykes, soft ore zones, backfill or support elements.

**Elasto-Plastic** - when checked this material will respond elasto-visco-plastically, i.e. the strength parameters will be used as a flow rule.

- This can be used to define zones with both different elastic properties and strength parameters.
- Note that in [Map3D Fault-Slip](#), only DD elements (i.e. fault gouge) are permitted to respond non-linearly.
- In [Map3D Non-Linear](#) and [Map3D Visco-Plastic](#) the 3D rock mass can also yield plastically.

**Inactive** - when checked this material will not be used in the stress analysis and hence will not affect the predicted stresses, strains or displacements.

- This can be used to define zones with different strength parameters to be used when generating contours of strength factors.

**User Defined** - allows specification of user defined parameters to be used in contouring.

- Different parameters are defined for each material number.
- These parameters are used with  [Plot > Stress > User](#)
- This can be used to define zones with different strength parameters to be used when generating contours of strength factors.

**Dump to File** - allows you to dump all material property data to a file for viewing in Notepad or Excel.

**Copy from material** - allows you to copy the material properties from one material number to another. All properties including the stress state are copied.

**Stress State** - specifies the initial (far field) stress state for the material.

- Most materials are inserted into blocks with the same (far field) stress state.
- Materials such as props or backfill are placed at near zero initial stresses.

Over-stressing can be presented in several ways including:

 [Plot > Strength Factors > dTip](#) In-Plane excess shear stress

 [Plot > Strength Factors > dTub](#) Ubiquitous-plane excess shear stress

  [Plot > Strength Factors > SF-ip](#) Strength/Stress

  [Plot > Strength Factors > SF-ub](#) Strength/Stress

By contrast, in non-linear analysis the stresses can never exceed the strength unless some creep is used (in this latter case, viscous creep can allow stress states above the failure criterion, thus indicating a lack of static equilibrium). Hence for non-linear analysis one normally directly considers the plastic strain or the plastic strain rate predicted by the model as an indicator of damage.

In DD planes, the elastic strains are determined from the stresses by

$$\tau_s = \tau^f + \text{Shear Modulus } \epsilon_s^{\text{elastic}}$$

$$\sigma_n = \sigma^f + \text{Normal Modulus } (\epsilon_n^{\text{elastic}} - \epsilon_n^t) / (B - \epsilon_n^{\text{elastic}})$$

where *Shear Modulus* and *Normal Modulus* represent respectively the elastic moduli of the gouge material in the shear and normal directions, and  $\tau^f$  and  $\sigma^f$  represent the initial stress state in the shear and normal directions, and

$$\varepsilon_s^{\text{elastic}} = \delta_s^{\text{elastic}} / \textit{Thickness}$$

$$\varepsilon_n^{\text{elastic}} = \delta_n^{\text{elastic}} / \textit{Thickness}$$

where  $\delta_{\text{elastic}}$  and  $\delta_{\text{normal}}$  represent respectively the elastic component of the shear displacement (ride) and normal displacement (closure) and *Thickness* represents the DD plane thickness (i.e. fault gouge, seam width, mining width or pillar height). The DD plane thickness is set using

 [CAD > Build > DDLoop](#)

and can be modified using

 [CAD > Edit > Entity Properties](#)

In DD elements, if the shear stress goes above the strength, the plastic strain can be determined by limiting the stress

$$\tau_s - \tau_s^{\circ} - C \Delta \varepsilon_s^{\text{plastic}} / \Delta t = \textit{Cohesion} + \tan(\varphi) (\sigma_n - \sigma_n^{\circ} - C \Delta \varepsilon_n^{\text{plastic}} / \Delta t)$$

where

$$\tau_s^{\circ} = \textit{Shear Modulus} \varepsilon_s^{\text{plastic}}$$

$$\sigma_n^{\circ} = \textit{Normal Modulus} \varepsilon_n^{\text{plastic}}$$

The accumulated plastic strain  $\varepsilon^{\text{plastic}}$ , is determined as the sum of the plastic creep increments  $\Delta \varepsilon^{\text{plastic}}$ , for all creep steps.

If the normal stress goes below the tension cutoff, the plastic strain can be determined by limiting the stress

$$\sigma_n - \sigma_n^{\circ} - C \Delta \varepsilon_n^{\text{plastic}} / \Delta t = T_0$$

In the case of shear failure, the plastic normal strain can also have a dilation component

$$\varepsilon_n^{\text{plastic}} = \tan(\textit{dilation angle}) \varepsilon_s^{\text{plastic}}$$

The total strain is equal to the sum of the elastic and plastic parts.

The creep response is simulated using a linear (Bingham) creep model.

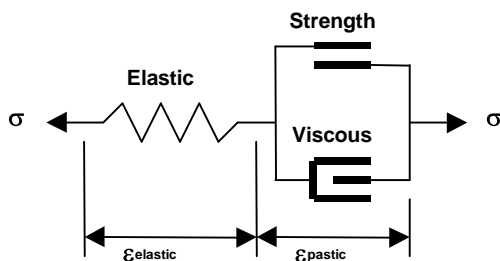

At each creep step the stress state on all yielding elements (elements where the stress exceeds the strength) is calculated as the strength plus the creep resistance

$$\textit{Strength} + C \Delta \varepsilon_n^{\text{plastic}} / \Delta t$$

$$C = G \Delta t$$

where the creep resistance is determined as the creep coefficient  $C$ , times the plastic strain rate. Note that the user must select both the creep coefficient  $C$ , and the time step size  $\Delta t$ , then specify the quotient of these as the viscous modulus  $G$ . The creep resistance can be used simply as a

technique for damping the non-linear deformations or for real time dependent creep simulation

[Analysis > Options > Creep](#)

The strains, shear displacement (ride) and normal displacement (closure) can be presented in several ways including:

$\epsilon^{el}$  [Plot > Surface > Value > Elastic](#)

$\epsilon^{pl}$  [Plot > Surface > Value > Plastic](#)

$\epsilon^{tot}$  [Plot > Surface > Value > Total](#)

$\epsilon_1$  [Plot > Strain > E1](#) - Major principal strain

$\epsilon_s$  [Plot > Surface > Es](#) Shear Strain

$\epsilon_n$  [Plot > Surface > En](#) Normal Strain

$\delta_s$  [Plot > Surface > ds](#) Shear Displacement (Ride)

$\delta_n$  [Plot > Surface > dn](#) Normal Displacement (Closure)

Also of interest is the plastic creep increment  $\Delta\epsilon_{plastic}$ , the contribution to the shear resistance from the viscous element

$$\Delta\tau_s = C \Delta\epsilon_s^{plastic} / \Delta t$$

$\Delta\epsilon_s$  [Plot > Surface > dEs](#) Incremental Shear Strain

$\Delta\tau_s$  [Plot > Surface > dTs](#) Excess Shear Stress

Related Topics:

[Mohr-Coulomb in DD planes](#)

[Fault-Gouge in DD planes](#)

#### 5.4.6 Materials > Quadratic-Backfill in DD Planes

Quadratic-Backfill material can be used to describe non-linear response in DD planes in both Map3D Fault-Slip, Map3D Non-Linear and Map3D Visco-Plastic.

Material Properties			
Material Name	Material #2		
Material #	2		
Material Type	Quadratic-Backfill (DD)		
	Peak	Residual	
Tension Cutoff	0	0	
Cohesion	10	10	
Friction Angle	30	30	
B <sub>et</sub>	1	0	
Normal Modulus	40000	40000	
Shear Modulus	24000	24000	
Standard Dev	0	<input type="radio"/> Elastic only <input checked="" type="radio"/> Elasto-Plastic <input type="radio"/> Inactive	
Viscous Mod (Gn)	0	User Defined Parameters	
Viscous Mod (Gs)	0	Dump to File	
Expansion Coef	1		
Conductivity	1		
<input type="button" value="Copy from matl..."/> <input type="button" value="Stress State"/> <input type="button" value="Close"/>			

**Material Name** - specifies a descriptive name for the material.

**Material #** - specifies the material number.

- Material #1 is reserved for the host material.
- Other material numbers are used to define alternate material zones such as ore, fault gouge, backfill etc.

**Material Type** - specifies the material type ([Mohr-Coulomb](#), [Hoek-Brown](#), [Drucker-Prager](#), [Fault-Gouge](#), [Hyperbolic-Backfill](#), [Quadratic-Backfill](#), [Equilibrated-Gouge](#), [Yielding-Pillar](#) or none).

- **Quadratic-Backfill** - defines the failure envelope as a straight line in the same as [Mohr-Coulomb in DD planes](#) but without *UCS*.
- Strength is defined in terms of in-plane shear and normal stresses as follows:

**Quadratic-Backfill in DD planes**

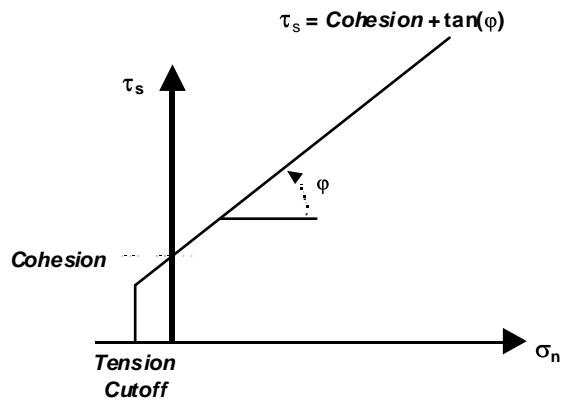

- **Tension Cutoff and Cohesion** are specified in units of stress (MPa or psi).
- **Friction angle and dilation angle** are specified in degrees.
- **Cohesion and friction angle** define the shear response.
- The **tension cutoff** defines the response in the direction normal to the shear plane.
- Peak values of these parameters are used up until failure.
- After yielding, the residual values are used to provide a strain softening response.

- Residual values are ignored in elastic analyses.
- If fluid pressure is specified as part of the [Stress State](#), the effective normal stress ( $\sigma_n - p$ ) is used (here  $p$  is the fluid pressure).

**B, et** - for DD planes the Backfill-Hyperbolic criterion defines the hyperbolic normal response as follows:

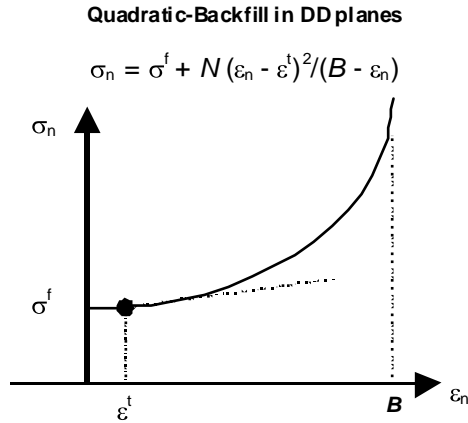

- The normal stress varies according to the hyperbolic relation.
- As the strain approaches the value  $B$  the normal stress rapidly become infinite thus limited the amount of normal displacement (closure) that can take place.

**Normal and Shear Modulus** - specify moduli in units of stress (MPa or psi).

- The normal response is defined above.  $N$  represents the value of the normal stress (for  $\sigma^f=0$ ) at  $\varepsilon_n = (\varepsilon^t - 1/2) + v(B - \varepsilon^t + 1/4)$ .
- The shear stresses acting on the surfaces of the elements are related to the elastic portion of the shear displacement (ride) through the shear modulus as in the [Fault-Gouge](#) model.

**Standard Deviation** - specify standard deviation in units of stress (MPa or psi).

- This parameter describes the uncertainty you have in the strength parameters.
- This parameter is only used for plotting the probability of shear failure [Plot > Strength Factors > In-Plane Probability N-distribution](#).

**Viscous Modulus ( $G_n$  and  $G_s$ )** - These parameters are used only in non-linear analyses (3D FF blocks in Map3D Non-Linear and DD planes in Map3D Fault-Slip).

- The viscous modulus describes the creep response. where the creep resistance is determined as the creep coefficient  $C$ , times the plastic strain rate. Note that the user must select both the creep coefficient  $C$ , and the time step size  $\Delta t$ , then specify the quotient of these as the viscous modulus  $G$ .
- $G_n$  is not used in the hyperbolic model.
- Specify the viscous modulus in units of stress (MPa or psi).

**Expansion Coefficient and Conductivity** are only used in [Map3D Thermal-Fluid Flow](#).

- Map3D Thermal-Fluid Flow can be used to simultaneously solve steady state heat/fluid flow coupled to the stress analysis.

**Elastic only** - when checked this material will respond elastically only, i.e. strength parameters will not be used.

- This can be used to define zones with different elastic properties and/or initial stress states. This

could include for example stiff dykes, soft ore zones, backfill or support elements.

**Elasto-Plastic** - when checked this material will respond elasto-visco-plastically, i.e. the strength parameters will be used as a flow rule.

- This can be used to define zones with both different elastic properties and strength parameters.
- Note that in [Map3D Fault-Slip](#), only DD elements (i.e. fault gouge) are permitted to respond non-linearly.
- In [Map3D Non-Linear](#) the 3D rock mass can also yield plastically.

**Inactive** - when checked this material will not be used in the stress analysis and hence will not affect the predicted stresses, strains or displacements.

- This can be used to define zones with different strength parameters to be used when generating contours of strength factors.

**User Defined** - allows specification of user defined parameters to be used in contouring.

- Different parameters are defined for each material number.
- These parameters are used with  [Plot > Stress > User](#)
- This can be used to define zones with different strength parameters to be used when generating contours of strength factors.

**Dump to File** - allows you to dump all material property data to a file for viewing in Notepad or Excel.

**Copy from material** - allows you to copy the material properties from one material number to another. All properties including the stress state are copied.

**Stress State** - specifies the initial (far field) stress state for the material.

- Most materials are inserted into blocks with the same (far field) stress state.
- Materials such as props or backfill are placed at near zero initial stresses.

Over-stressing can be presented in several ways including:

 [Plot > Strength Factors > dTip](#) In-Plane excess shear stress

 [Plot > Strength Factors > dTub](#) Ubiquitous-plane excess shear stress

  [Plot > Strength Factors > SF-ip](#) Strength/Stress

  [Plot > Strength Factors > SF-ub](#) Strength/Stress

By contrast, in non-linear analysis the stresses can never exceed the strength unless some creep is used (in this latter case, viscous creep can allow stress states above the failure criterion, thus indicating a lack of static equilibrium). Hence for non-linear analysis one normally directly considers the plastic strain or the plastic strain rate predicted by the model as an indicator of damage.

In DD planes, the elastic strains are determined from the stresses by

$$\tau_s = \tau^f + \text{Shear Modulus } \varepsilon_s^{\text{elastic}}$$

$$\sigma_n = \sigma^f + \text{Normal Modulus } (\varepsilon_n^{\text{elastic}} - \varepsilon_n^t) / (B - \varepsilon_n^{\text{elastic}})$$

where *Shear Modulus* and *Normal Modulus* represent respectively the elastic moduli of the gouge material in the shear and normal directions, and  $\tau^f$  and  $\sigma^f$  represent the initial stress state in the shear and normal directions, and

$$\varepsilon_s^{\text{elastic}} = \delta_s^{\text{elastic}} / \text{Thickness}$$

$$\varepsilon_n^{\text{elastic}} = \delta_n^{\text{elastic}} / \text{Thickness}$$

where  $\delta_{s\text{elastic}}$  and  $\delta_{n\text{elastic}}$  represent respectively the elastic component of the shear displacement (ride) and normal displacement (closure) and *Thickness* represents the DD plane thickness (i.e. fault



gouge, seam width, mining width or pillar height). The DD plane thickness is set using

 [CAD > Build > DDLoop](#)

and can be modified using

 [CAD > Edit > Entity Properties](#)

In DD elements, if the shear stress goes above the strength, the plastic strain can be determined by limiting the stress

$$\tau_s - \tau_s^o - C \Delta \varepsilon_s^{plastic} / \Delta t = Cohesion + \tan(\varphi) (\sigma_n - \sigma_n^o - C \Delta \varepsilon_n^{plastic} / \Delta t)$$

where

$$\tau_s^o = Shear\ Modulus \ \varepsilon_s^{plastic}$$

$$\sigma_n^o = Normal\ Modulus \ \varepsilon_n^{plastic}$$

The accumulated plastic strain  $\varepsilon^{plastic}$ , is determined as the sum of the plastic creep increments  $\Delta \varepsilon^{plastic}$ , for all creep steps.

If the normal stress goes below the tension cutoff, the plastic strain can be determined by limiting the stress

$$\sigma_n - \sigma_n^o - C \Delta \varepsilon_n^{plastic} / \Delta t = T_o$$

In the case of shear failure, the plastic normal strain can also have a dilation component

$$\varepsilon_n^{plastic} = \tan(dilation\ angle) \ \varepsilon_s^{plastic}$$

The total strain is equal to the sum of the elastic and plastic parts.

The creep response is simulated using a linear (Bingham) creep model.

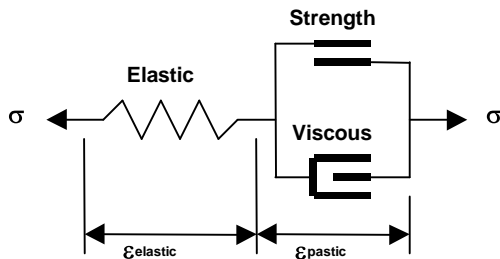

At each creep step the stress state on all yielding elements (elements where the stress exceeds the strength) is calculated as the strength plus the creep resistance

$$Strength + C \Delta \varepsilon_n^{plastic} / \Delta t$$

$$C = G \Delta t$$

where the creep resistance is determined as the creep coefficient  $C$ , times the plastic strain rate. Note that the user must select both the creep coefficient  $C$ , and the time step size  $\Delta t$ , then specify the quotient of these as the viscous modulus  $G$ . The creep resistance can be used simply as a technique for damping the non-linear deformations or for real time dependent creep simulation

[Analysis > Options > Creep](#)

The strains, shear displacement (ride) and normal displacement (closure) can be presented in several ways including:

$\epsilon^{el}$  [Plot > Surface > Value > Elastic](#)

$\epsilon^{pl}$  [Plot > Surface > Value > Plastic](#)

$\epsilon^{tot}$  [Plot > Surface > Value > Total](#)

$\epsilon_1$  [Plot > Strain > E1](#) - Major principal strain

$\epsilon_s$  [Plot > Surface > Es](#) Shear Strain

$\epsilon_n$  [Plot > Surface > En](#) Normal Strain

$\delta_s$  [Plot > Surface > ds](#) Shear Displacement (Ride)

$\delta_n$  [Plot > Surface > dn](#) Normal Displacement (Closure)

Also of interest is the plastic creep increment  $\Delta\epsilon_{plastic}$ , the contribution to the shear resistance from the viscous element

$$\Delta\tau_s = C \Delta\epsilon_s^{plastic} / \Delta t$$

$\Delta\epsilon_s$  [Plot > Surface > dEs](#) Incremental Shear Strain

$\Delta\tau_s$  [Plot > Surface > dTs](#) Excess Shear Stress

Related Topics:

[Mohr-Coulomb in DD planes](#)

[Fault-Gouge in DD planes](#)

## 5.4.7 Materials > Equilibrated-Gouge in DD Planes

Equilibrated-Gouge material can be used to describe non-linear response in DD planes in both Map3D Fault-Slip and Map3D Non-Linear.

This material is similar to the [Fault-Gouge](#) material type but automatically adjusts the strength parameters to place the gouge into critical equilibrium at the first mining step.

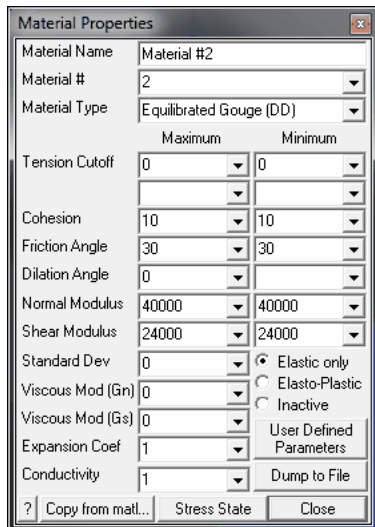

At step 1 of the stress analysis, the elastic stresses are calculated at all locations on the DD fault

plane.

From this information, the required strength parameters (Cohesion and friction angle) are determined by interpolation such that every location is exactly at the point of failure.

This is done by linearly interpolating between the specified minimum and maximum strength values. If the elastic stress falls below the minimum, the minimum is used. If the elastic stress falls above the maximum, the maximum is used.

The interpolated strength values are then used for all subsequent mining steps.

This can be considered to be the worst case scenario where any mining induced stress change has the potential to cause slip on the fault.

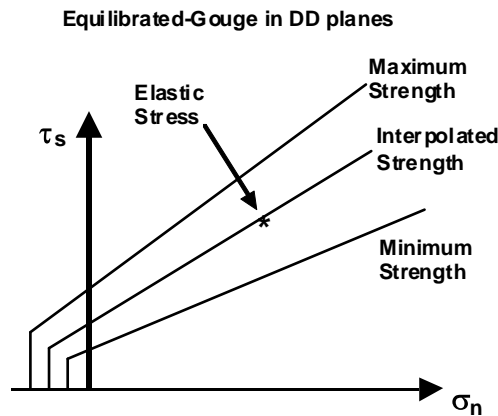

**Material Name** - specifies a descriptive name for the material.

**Material #** - specifies the material number.

- Material #1 is reserved for the host material.
- Other material numbers are used to define alternate material zones such as ore, fault gouge, backfill etc.

**Material Type** - specifies the material type ([Mohr-Coulomb](#), [Hoek-Brown](#), [Drucker-Prager](#), [Fault-Gouge](#), [Hyperbolic-Backfill](#), [Quadratic-Backfill](#), [Equilibrated-Gouge](#), [Yielding-Pillar](#) or none).

- [Fault-Gouge](#) - defines the failure envelope as a straight line in the same as [Mohr-Coulomb in DD planes](#) but without *UCS*.
- Strength is defined in terms of in-plane shear and normal stresses as follows:

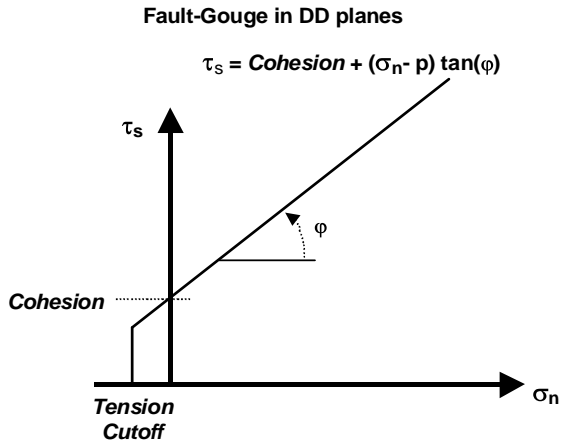

- **Tension Cutoff and Cohesion** are specified in units of stress (MPa or psi).
- **Friction angle and dilation angle** are specified in degrees.
- **Cohesion and friction angle** define the shear response.
- The **tension cutoff** defines the response in the direction normal to the shear plane.
- Maximum values specify the maximum allowable interpolated strength.
- Min values specify the minimum allowable interpolated strength.
- If fluid pressure is specified as part of the [Stress State](#), the effective normal stress ( $\sigma_n - p$ ) is used (here  $p$  is the fluid pressure).

**Normal and Shear Modulus** - specify moduli in units of stress (MPa or psi).

- In DD planes the shear and normal stresses acting on the surfaces of the element are related to the elastic portion of the shear displacement (ride) and normal displacement (closure) through the shear and normal moduli.
- Peak values of these parameters are used up until failure.
- After yielding, the residual values are used.

**Standard Deviation** - specify standard deviation in units of stress (MPa or psi).

- This parameter describes the uncertainty you have in the strength parameters.
- This parameter is only used for plotting the probability of shear failure [Plot > Strength Factors > In-Plane Probability N-distribution](#).

**Viscous Modulus ( $G_n$  and  $G_s$ )** - These parameters are used only in non-linear analyses (3D FF blocks in Map3D Non-Linear and DD planes in Map3D Fault-Slip).

- The viscous modulus describes the creep response. where the creep resistance is determined as the creep coefficient  $C$ , times the plastic strain rate.
- Note that the user must select both the creep coefficient  $C$ , and the time step size  $\Delta t$ , then specify the quotient of these as the viscous modulus  $G$ .
- Specify the viscous modulus in units of stress (MPa or psi).

**Expansion Coefficient and Conductivity** are only used in [Map3D Thermal-Fluid Flow](#).

- Map3D Thermal-Fluid Flow can be used to simultaneously solve steady state heat/fluid flow coupled to the stress analysis.

**Elastic only** - when checked this material will respond elastically only, i.e. strength parameters will not be used.

- This can be used to define zones with different elastic properties and/or initial stress states. This could include for example stiff dykes, soft ore zones, backfill or support elements.

**Elasto-Plastic** - when checked this material will respond elasto-visco-plastically, i.e. the strength parameters will be used as a flow rule.

- This can be used to define zones with both different elastic properties and strength parameters.
- Note that in [Map3D Fault-Slip](#), only DD elements (i.e. fault gouge) are permitted to respond non-linearly.
- In [Map3D Non-Linear](#) the 3D rock mass can also yield plastically.

**Inactive** - when checked this material will not be used in the stress analysis and hence will not affect the predicted stresses, strains or displacements.

- This can be used to define zones with different strength parameters to be used when generating contours of strength factors.

**User Defined** - allows specification of user defined parameters to be used in contouring.

- Different parameters are defined for each material number.
- These parameters are used with [User](#) [Plot > Stress > User](#)
- This can be used to define zones with different strength parameters to be used when generating contours of strength factors.

**Dump to File** - allows you to dump all material property data to a file for viewing in Notepad or Excel.

**Copy from material** allows you to copy the material properties from one material number to another. All properties including the stress state are copied.

**Stress State** - specifies the initial (far field) stress state for the material.

- Most materials are inserted into blocks with the same (far field) stress state.
- Materials such as props or backfill are placed at near zero initial stresses.

In elastic analysis the shear and normal stresses in the plane of weakness (on a fault, joint set or bedding plane) are normally used with the Mohr-Coulomb strength criterion to estimate the amount of damage due to over-stressing. One can expect that more excess stress in an elastic analysis would in general correlate with increased amounts of plastic strain (slip) in a non-linear analysis. Since these parameters are orientation dependant, this criterion is representative for anisotropic rock mass stability.

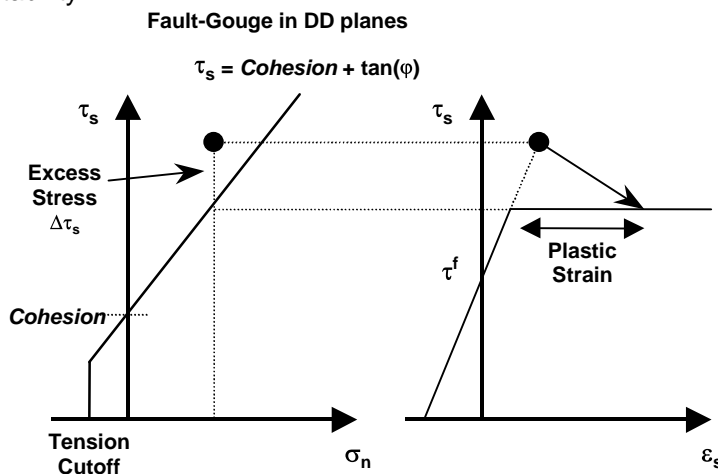

Over-stressing can be presented in several ways including:

[Δτ<sub>ip</sub>](#) [Plot > Strength Factors > dTip](#) In-Plane excess shear stress

[τ<sub>ub</sub>](#) [Plot > Strength Factors > dTub](#) Ubiquitous-plane excess shear stress

  [Plot > Strength Factors > SF-ip](#) Strength/Stress

  [Plot > Strength Factors > SF-ub](#) Strength/Stress

By contrast, in non-linear analysis the stresses can never exceed the strength unless some creep is used (in this latter case, viscous creep can allow stress states above the failure criterion, thus indicating a lack of static equilibrium). Hence for non-linear analysis one normally directly considers the plastic strain or the plastic strain rate predicted by the model as an indicator of damage.

In DD planes, the elastic strains are determined from the stresses by

$$\tau_s = \tau_f + \textit{Shear Modulus} \epsilon_{\text{elastic}}$$

$$\sigma_n = \sigma_f + \textit{Normal Modulus} \epsilon_{\text{elastic}}$$

where *Shear Modulus* and *Normal Modulus* represent respectively the elastic moduli of the gouge material in the shear and normal directions, and  $\tau_f$  and  $\sigma_f$  represent the initial stress state in the shear and normal directions, and

$$\epsilon_{\text{elastic}} = \delta_{\text{elastic}} / \textit{Thickness}$$

$$\epsilon_{\text{elastic}} = \delta_{\text{elastic}} / \textit{Thickness}$$

where  $\delta_{\text{elastic}}$  and  $\delta_{\text{elastic}}$  represent respectively the elastic component of the shear displacement (ride) and normal displacement (closure) and *Thickness* represents the DD plane thickness (i.e. fault gouge, seam width, mining width or pillar height). The DD plane thickness is set using

 [CAD > Build > DDLoop](#)

and can be modified using

 [CAD > Edit > Entity Properties](#)

In DD elements, if the shear stress goes above the strength, the plastic strain can be determined by limiting the stress

$$\tau_s - \tau_s^{\circ} - C \Delta \epsilon_{\text{plastic}} / \Delta t = \textit{Cohesion} + \tan(\varphi) (\sigma_n - \sigma_n^{\circ} - C \Delta \epsilon_{\text{plastic}} / \Delta t)$$

where

$$\tau_s^{\circ} = \textit{Shear Modulus} \epsilon_{\text{plastic}}$$

$$\sigma_n^{\circ} = \textit{Normal Modulus} \epsilon_{\text{plastic}}$$

The accumulated plastic strain  $\epsilon_{\text{plastic}}$ , is determined as the sum of the plastic creep increments  $\Delta \epsilon_{\text{plastic}}$ , for all creep steps.

If the normal stress goes below the tension cutoff, the plastic strain can be determined by limiting the stress

$$\sigma_n - \sigma_n^{\circ} - C \Delta \epsilon_{\text{plastic}} / \Delta t = T_0$$

In the case of shear failure, the plastic normal strain can also have a dilation component

$$\epsilon_{\text{plastic}} = \tan(\textit{dilation angle}) \epsilon_{\text{plastic}}$$

The total strain is equal to the sum of the elastic and plastic parts.

The creep response is simulated using a linear (Bingham) creep model.

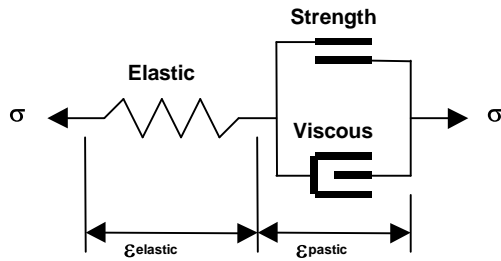

At each creep step the stress state on all yielding elements (elements where the stress exceeds the strength) is calculated as the strength plus the creep resistance

$$\text{Strength} + C \Delta \epsilon_{\text{plastic}} / \Delta t$$

$$C = G \Delta t$$

where the creep resistance is determined as the creep coefficient  $C$ , times the plastic strain rate. Note that the user must select both the creep coefficient  $C$ , and the time step size  $\Delta t$ , then specify the quotient of these as the viscous modulus  $G$ . The creep resistance can be used simply as a technique for damping the non-linear deformations or for real time dependent creep simulation

[Analysis > Options > Creep](#)

The strains, shear displacement (ride) and normal displacement (closure) can be presented in several ways including:

$\epsilon^{\text{el}}$  [Plot > Surface > Value > Elastic](#)

$\epsilon^{\text{pl}}$  [Plot > Surface > Value > Plastic](#)

$\epsilon^{\text{tot}}$  [Plot > Surface > Value > Total](#)

$\epsilon_1$  [Plot > Strain > E1](#) - Major principal strain

$\epsilon_s$  [Plot > Surface > Es](#) Shear Strain

$\epsilon_n$  [Plot > Surface > En](#) Normal Strain

$\delta_s$  [Plot > Surface > ds](#) Shear Displacement (Ride)

$\delta_n$  [Plot > Surface > dn](#) Normal Displacement (Closure)

Also of interest is the plastic creep increment  $\Delta \epsilon_{\text{plastic}}$ , the contribution to the shear resistance from the viscous element

$$\Delta \tau_s = C \Delta \epsilon_{\text{plastic}} / \Delta t$$

$\Delta \epsilon_s$  [Plot > Surface > dEs](#) Incremental Shear Strain

$\Delta \tau_s$  [Plot > Surface > dTs](#) Excess Shear Stress

Related Topics:

[Mohr-Coulomb in DD planes](#)

[Backfill-Hyperbolic in DD planes](#)

### 5.4.8 Materials > Yielding-Pillar in DD Planes

Yielding-Pillar material can be used to describe non-linear response in DD planes in both Map3D Fault-Slip and Map3D Non-Linear.

	Peak	Residual
Tension Cutoff	0	0
UCS (rockmass)	20	20
Cohesion	10	10
Friction Angle	30	30
Dilatation Angle	0	
Normal Modulus	40000	40000
Shear Modulus	24000	24000
Standard Dev	0	
Viscous Mod (Gn)	0	
Viscous Mod (Gs)	0	
Expansion Coef	1	
Conductivity	1	

Material Name: Material #2  
Material #: 2  
Material Type: Yielding Pillar (DD)

Options:  Elastic only,  Elasto-Plastic,  Inactive  
 User Defined Parameters  
 Dump to File

**Material Name** - specifies a descriptive name for the material.

**Material #** - specifies the material number.

- Material #1 is reserved for the host material.
- Other material numbers are used to define alternate material zones such as ore, fault gouge, backfill etc.

**Material Type** - specifies the material type ([Mohr-Coulomb](#), [Hoek-Brown](#), [Drucker-Prager](#), [Fault-Gouge](#), [Hyperbolic-Backfill](#), [Quadratic-Backfill](#), [Equilibrated-Gouge](#), [Yielding-Pillar](#) or none).

- **Mohr-Coulomb** - defines the failure envelope as a straight line.
- For DD planes the Mohr-Coulomb criterion defines strength in terms of in-plane shear and normal stresses as follows:

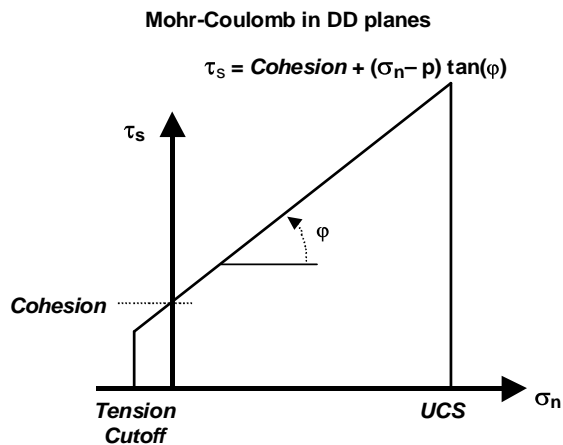

- **Tension Cutoff**, **Cohesion** and **UCS** are specified in units of stress (MPa or psi).



- [Friction angle and dilation angle](#) are specified in degrees.
- [Cohesion and friction](#) angle define the shear response.
- The [tension cutoff](#) and [UCS](#) define the response in the direction normal to the shear plane. Here [UCS](#) permits simulation of yielding pillars.
- Peak values of these parameters are used up until failure.
- After yielding, the residual values are used to provide a strain softening response. Residual values are ignored in elastic analyses.
- If fluid pressure is specified as part of the [Stress State](#), the effective normal stress ( $\sigma_n - p$ ) is used (here  $p$  is the fluid pressure).

[Young's Modulus and Poisson's Ratio](#) specify Young's Modulus in units of stress (MPa or psi).

- In DD planes the shear and normal stresses acting on the surfaces of the element are related to the elastic portion of the shear displacement (ride) and normal displacement (closure) through the shear and normal moduli

$$\text{Shear Modulus} = E / [ 2 (1+\nu) ]$$

$$\text{Normal Modulus} = E / [ 3 (1-2\nu) ]$$

- Peak values of these parameters are used up until failure.
- After yielding, the residual values are used.
- Residual values are ignored in elastic analyses.

[Standard Deviation](#) - specify standard deviation in units of stress (MPa or psi).

- This parameter describes the uncertainty you have in the strength parameters.
- This parameter is only used for plotting the probability of shear failure [Plot > Strength Factors > In-Plane Probability N-distribution](#).

[Viscous Modulus \( \$G\_n\$  and  \$G\_s\$ \)](#) - These parameters are used only in non-linear analyses (3D FF blocks in Map3D Non-Linear and DD planes in Map3D Fault-Slip).

- The viscous modulus describes the creep response. where the creep resistance is determined as the creep coefficient  $C$ , times the plastic strain rate. Note that the user must select both the creep coefficient  $C$ , and the time step size  $\Delta t$ , then specify the quotient of these as the viscous modulus  $G$ .
- Specify the viscous modulus in units of stress (MPa or psi).

[Expansion Coefficient and Conductivity](#) are only used in [Map3D Thermal-Fluid Flow](#).

- Map3D Thermal-Fluid Flow can be used to simultaneously solve steady state heat/fluid flow coupled to the stress analysis.

[Elastic only](#) - when checked this material will respond elastically only, i.e. strength parameters will not be used.

- This can be used to define zones with different elastic properties and/or initial stress states. This could include for example stiff dykes, soft ore zones, backfill or support elements.

[Elasto-Plastic](#) - when checked this material will respond elasto-visco-plastically, i.e. the strength parameters will be used as a flow rule.

- This can be used to define zones with both different elastic properties and strength parameters.
- Note that in [Map3D Fault-Slip](#), only DD elements (i.e. fault gouge) are permitted to respond non-linearly.
- In [Map3D Non-Linear](#) the 3D rock mass can also yield plastically.

[Inactive](#) - when checked this material will not be used in the stress analysis and hence will not affect the predicted stresses, strains or displacements.

- This can be used to define zones with different strength parameters to be used when generating

contours of strength factors.

[User Defined](#) - allows specification of user defined parameters to be used in contouring.

- Different parameters are defined for each material number.
- These parameters are used with [User](#) [Plot > Stress > User](#)
- This can be used to define zones with different strength parameters to be used when generating contours of strength factors.

[Dump to File](#) - allows you to dump all material property data to a file for viewing in Notepad or Excel.

[Copy from material](#) allows you to copy the material properties from one material number to another. All properties including the stress state are copied.

[Stress State](#) - specifies the initial (far field) stress state for the material.

- Most materials are inserted into blocks with the same (far field) stress state.
- Materials such as props or backfill are placed at near zero initial stresses.

In elastic analysis the shear and normal stresses in the plane of weakness (on a fault, joint set or bedding plane) are normally used with the Mohr-Coulomb strength criterion to estimate the amount of damage due to over-stressing. One can expect that more excess stress in an elastic analysis would in general correlate with increased amounts of plastic strain (slip) in a non-linear analysis. Since these parameters are orientation dependant, this criterion is representative for anisotropic rock mass stability.

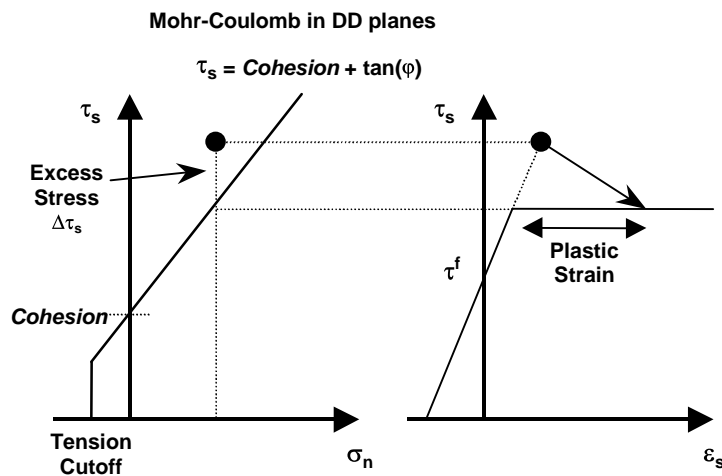

Over-stressing can be presented in several ways including:

- [Plot > Strength Factors > dTip](#) In-Plane excess shear stress
- [Plot > Strength Factors > dTub](#) Ubiquitous-plane excess shear stress
- [Plot > Strength Factors > SF-ip](#) Strength/Stress
- [Plot > Strength Factors > SF-ub](#) Strength/Stress

By contrast, in non-linear analysis the stresses can never exceed the strength unless some creep is used (in this latter case, viscous creep can allow stress states above the failure criterion, thus indicating a lack of static equilibrium). Hence for non-linear analysis one normally directly considers the plastic strain or the plastic strain rate predicted by the model as an indicator of damage.

In DD planes, the elastic strains are determined from the stresses by

$$\tau_s = \tau_f + \textit{Shear Modulus} \epsilon_{\text{elastic}}$$

$$\sigma_n = \sigma_f + \textit{Normal Modulus} \epsilon_{\text{elastic}}$$

where *Shear Modulus* and *Normal Modulus* represent respectively the elastic moduli of the gouge material in the shear and normal directions, and  $\tau_f$  and  $\sigma_f$  represent the initial stress state in the shear and normal directions, and

$$\epsilon_{\text{elastic}} = \delta_{\text{elastic}} / \textit{Thickness}$$

$$\epsilon_{\text{elastic}} = \delta_{\text{elastic}} / \textit{Thickness}$$

where  $\delta_{\text{elastic}}$  and  $\delta_{\text{elastic}}$  represent respectively the elastic component of the shear displacement (ride) and normal displacement (closure) and *Thickness* represents the DD plane thickness (i.e. fault gouge, seam width, mining width or pillar height). The DD plane thickness is set using

 [CAD > Build > DDLoop](#)

and can be modified using

 [CAD > Edit > Entity Properties](#)

In DD elements, if the shear stress goes above the strength, the plastic strain can be determined by limiting the stress

$$\tau_s - \tau_s^o - C \Delta\epsilon_{\text{plastic}} / \Delta t = \textit{Cohesion} + \tan(\varphi) (\sigma_n - \sigma_n^o - C \Delta\epsilon_{\text{plastic}} / \Delta t)$$

where

$$\tau_s^o = \textit{Shear Modulus} \epsilon_{\text{plastic}}$$

$$\sigma_n^o = \textit{Normal Modulus} \epsilon_{\text{plastic}}$$

The accumulated plastic strain  $\epsilon_{\text{plastic}}$ , is determined as the sum of the plastic creep increments  $\Delta\epsilon_{\text{plastic}}$ , for all creep steps.

If the normal stress goes below the tension cutoff, the plastic strain can be determined by limiting the stress

$$\sigma_n - \sigma_n^o - C \Delta\epsilon_{\text{plastic}} / \Delta t = T_o$$

If the normal stress goes above the *UCS*, the plastic strain can be determined by limiting the stress

$$\sigma_n - \sigma_n^o - C \Delta\epsilon_{\text{plastic}} / \Delta t = \textit{UCS}$$

In the case of shear failure, the plastic normal strain can also have a dilation component

$$\epsilon_{\text{plastic}} = \tan(\textit{dilation angle}) \epsilon_{\text{plastic}}$$

The total strain is equal to the sum of the elastic and plastic parts.

The creep response is simulated using a linear (Bingham) creep model.

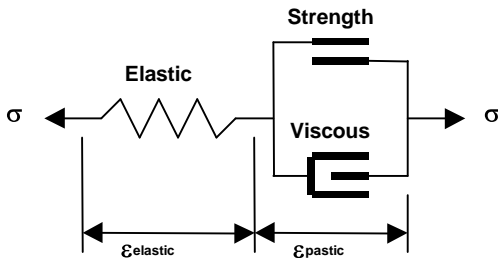

At each creep step the stress state on all yielding elements (elements where the stress exceeds the

strength) is calculated as the strength plus the creep resistance

$$\text{Strength} + C \Delta \epsilon_{\text{plastic}} / \Delta t$$

$$C = G \Delta t$$

where the creep resistance is determined as the creep coefficient  $C$ , times the plastic strain rate. Note that the user must select both the creep coefficient  $C$ , and the time step size  $\Delta t$ , then specify the quotient of these as the viscous modulus  $G$ . The creep resistance can be used simply as a technique for damping the non-linear deformations or for real time dependent creep simulation

[Analysis > Options > Creep](#)

The strains, shear displacement (ride) and normal displacement (closure) can be presented in several ways including:

 [Plot > Surface > Value > Elastic](#)

 [Plot > Surface > Value > Plastic](#)

 [Plot > Surface > Value > Total](#)

 [Plot > Strain > E1](#) - Major principal strain

 [Plot > Surface > Es](#) Shear Strain

 [Plot > Surface > En](#) Normal Strain

 [Plot > Surface > ds](#) Shear Displacement (Ride)

 [Plot > Surface > dn](#) Normal Displacement (Closure)

Also of interest is the plastic creep increment  $\Delta \epsilon_{\text{plastic}}$ , the contribution to the shear resistance from the viscous element

$$\Delta \tau_s = C \Delta \epsilon_{\text{plastic}} / \Delta t$$

 [Plot > Surface > dEs](#) Incremental Shear Strain

 [Plot > Surface > dTs](#) Excess Shear Stress

Related Topics:

[Fault-Gouge in DD planes](#)

[Backfill-Hyperbolic in DD planes](#)

### 5.4.9 Materials > User Defined Parameters

Allows specification of user defined parameters to be used in contouring.

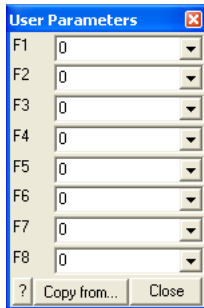

These parameters are used with [User Plot > Stress > User](#)

Different parameters are defined for each material number. Hence analysis results that are calculated in different alternate material zones will use the user defined parameters appropriate for each zone.

### 5.4.10 Materials > Dump to File

Allows you to dump all material property data to a file for viewing in Notepad or Excel.

You will be prompted to select a file name for the dump.

Options include:

- [Open in Excel](#)
- [Open in Notepad](#)
- [Use commas as decimal points](#)

File formats available include:

- [csv](#) - comma separated values (useful for direct import into Excel)
- [tsv](#) - tab separated values (useful for direct import into Excel)
- [txt](#) - space separated values (useful for direct import into Notepad)

### 5.4.11 Materials > Expansion Coefficient and Conductivity

[Map3D Thermal-Fluid Flow](#) can be used to simultaneously solve steady state heat/fluid flow coupled to the stress analysis. The program is set up so that the user need only specify the temperature/head boundary conditions, then the coupled thermal/fluid flow stress problem is solved simultaneously. This feature is useful for the simulation of heating or cooling effects and drained or undrained response of soils.

The steady state thermal/fluid flow problem is solved according to Laplace's equation in three-dimensions. This is directly coupled to the stress analysis through an expansion coefficient  $A$ , where the temperature change or fluid pressure change (from the background value) induces the initial stresses

$$\sigma^{\circ} = A \Delta T$$

The stresses can be presented either without or with the initial stresses  $\sigma^{\circ}$ .

 [Plot > Stress > Value > Seff](#) Effective Stress

 [Plot > Stress > Value > Stotal](#) Total Stress

For fluid flow problems the expansion coefficient should be set to unity (positive one) for saturated media

$$A = 1$$

For thermal problems the expansion coefficient should be specified as a negative quantity given by

$$A = -\alpha E / (1-2\nu)$$

where  $\alpha$ ,  $E$  and  $\nu$  represent the coefficient of thermal expansion (i.e. the linear expansivity), Young's modulus and Poisson's ratio.

It is also necessary to specify the conductivity  $C$ . This parameter relates the gradient to the flux  $q_x$  such that

$$q_x = -C \partial T / \partial x$$

The recommended units for  $C$  are J/(m s 8C).

The various flow parameters can be plotted using

 [Plot > Flow](#)

## 5.5 Dock the View Toolbar

Dock to View Toolbar at the top of the window.

## 5.6 Dock the Contour Toolbar

Dock to CAD/Solve/Contour Toolbar at the side of the window.

## 5.7 Map3D Analysis Stages

A Map3D analysis proceeds in five stages:

### Stage 1 – Model building and editing

This stage is used to setup the Map3D analysis.

[Analysis > Go to CAD](#)

The user can add new mining blocks and edit existing blocks using the CAD functions built into Map3D. This can include tunnels, large irregular shaped excavations, ore zones, massive and tabular excavations, open pits, faults, fractures and more.

Various parts of the model can be saved in separate component files and merged for final analysis.

[Analysis > Load Model](#)

At this stage, material properties are assigned and the desired mining sequence is set up. This can include ore placement, excavation and backfilling.

Field point grids are positioned at locations where off reef results are desired. For the case of tabular

excavations, often only on reef results are required and hence field points grids are optional.

### Stage 2 – Contact and intersection analysis

[Analysis > Intersections.](#)

Intersections are built between blocks that cut through one another. Boolean operations are performed to resolve the mining sequence. Comprehensive model integrity checking is conducted.

### Stage 3 – Block and grid discretization

[Analysis > Discretization.](#)

The model is discretized into boundary elements to be used in the BEM analysis. The user has complete control over the way in which the model is discretized. This can be conducted automatically by the program concentrating results only where results are requested, or specified manually.

### Stage 4 – Map3D BEM analysis

[Analysis > BEM Analysis.](#)

Conducts the Boundary Element Analysis. The same input data can be used for elastic, thermal/fluid flow or non-linear analysis

[Map3D Versions](#)

### Stage 5 – Post-processing

[Analysis > Graphics.](#)

This stage is used to view and process the Map3D analysis results. Contour plots of stress, strain, displacement and strength factors, or any desired combination of these components can be generated on boundary surfaces and on user defined field point grids. Results can be displayed either as total values, or the difference in value between mining steps.

Results from previous analyses can be loaded for viewing

[File > Open Analysis Results.](#)

## 5.8 Map3D Versions

	<b>Map3D Basic</b> 32-bit, 1-core	<b>Map3D Professional</b> 64-bit, 4-core	<b>Map3D Suite</b> 64-bit, 8-core
Multi-processor	×	✓ 4 core processing	✓ 8 core processing
Multi-disk access	×	✓ parallel disk access	✓ parallel disk access
64-bit	×	✓ 64 bit	✓ 64 bit
3DPDF	×	✓	✓
CAD, Stress Analysis, Results Viewer, Visualization Database	✓	✓	✓

Map3D Fault-Slip	✓	✓	✓
Map3D Integrated-Seismicity	×	✓	✓
Map3D 3D Non-Linear	×	×	✓
Map3D 3D-Plasticity	×	×	✓
Problem size	200,000 elements 400,000 nodes	2,000,000 elements* 8,000,000 nodes	2,000,000 elements* 8,000,000 nodes

\* larger capacity available if requested

### **Map3D Modeller** - features 3D CAD and Visual Database capabilities.

Easy to use 3D CAD (OpenGL based graphics) system includes free-hand sketching or object picking to build and edit 5 basic entity types:

- 3D blocks (e.g. stopes, ore zones, dykes, tunnels),
- 2D features (e.g. faults, tabular mining, topography, fractures)
- grid planes (e.g. cross-sections)
- grid lines (e.g. bore holes, ground support)
- construction lines (e.g. survey data, drift centre lines)

Includes a full sweet of editing functions including copy, move, stretch, flatten, scale, rotate and more. Full dxf and pnt import/export capability to exchange data with other CAD programs.

The visual database can be used to display a database of any desired information including seismic or geologic information such as grade, rock mass quality etc. 3D points can be tagged with a series of:

- numeric values (e.g. colour, magnitude, orientation etc.),
- keywords (for filtering),
- text messages,
- file names (e.g. graphics files, documents, spreadsheets etc.).

Display of these items can be filtered in various ways. The location of each point can be displayed as colour shaded spheres or squares. The size and colour can be scaled according to various combinations of parameters. Point magnitude density can be contoured on a plane according to a user defined density function. A best-fit plane can be fitted using linear-regression.

### **Map3D Results Viewer** - features stand-alone viewing of stress analysis results.

Includes the visual database but not the CAD system.

- views stress analysis results generated by any of the Map3D analysis codes
- displays contours on cutting planes, along lines and at specific points
- user defined contouring functions
- direct link to Excel for plotting x-y graphs
- display of 3D trajectories
- display of all stress, strain, displacement and strength parameters including principal components and resultant values on user defined planes and lines.
- export in dxf and pnt format for compatibility with other CAD and display systems
- probability of failure contours
- safety factor contour



- light source shaded models
- topographical contours

**Map3D Fault-Slip** - adds elastic rock mass and fully plastic fault-slip stress analysis capabilities.

Includes the 3D CAD modeller, the results viewer and the visual database.

The stress analysis utilizes the BEM (boundary element method) and has many features:

- the ability to analyze very large problem sizes (one million degrees of freedom)
- full 3D complex excavation shapes
- multiple elastic zones with different moduli (stiff dykes or soft ore)
- zones with different pre-mining stress state
- tabular mining with yielding pillars
- discrete non-planar fault planes that slip and dilate elasto-visco-plastically (including creep)
- multiple mining steps (40)
- automatic intersections allowing for excavations and faults to cross and overlap

A demonstration version of Map3D Fault-Slip is available at no charge. All features are available except the user is only permitted to run small size problems. This version is extremely useful for teaching the fundamentals of modelling and 3D CAD.

**Map3Di Integrated Seismicity** - allows one to superimpose external field loading effects into the stress analysis.

Includes all capabilities from Map3D Fault-Slip and adds the field loading effects. The field loading can come from thermal heating, fluid pressure, non-linear behaviour and deformations indicated by seismicity. These effects can be used to characterize geologic features, accommodate changing lithology and incorporate seismic loading effects into the stress analysis.

**Map3D Thermal-Fluid Flow** - adds thermal stress - fluid flow analysis.

Includes all capabilities from Map3D Fault-Slip and adds simultaneous solution of steady state thermal stress - fluid flow. The program is set up so that the user need only specify the temperature/head boundary conditions, then the thermal stress problem is solved simultaneously. This feature is useful for simulation of heating/cooling effects and drained/undrained response.

**Map3D Non-Linear** - adds non-linear rock mass response.

Includes all capabilities from Map3D Fault-Slip and adds the capability for the 3D rock mass to yield to loads that exceed the rock strength, and deform non-linearly to dissipate the excess stresses. This feature is useful for simulation of thick seams, over-stressed pillars, abutments, backfill and creep response. This formulation solves the non-linear problem on the surface of the boundary elements and interpolates these effects between these boundaries. This represents a first approximation to inelastic modelling that boasts the advantage of large problem sizes and very fast execution speeds.

**Map3D Visco-Plastic** - adds 3D elasto-visco-plastic rock mass response (still under development - not available commercially at this time).

Includes all capabilities from Map3D Fault-Slip and adds the capability for the 3D rock mass to behave elasto-visco-plastically. This model features a full solution of the non-associated

incremental plasticity equations and adds the capability for the 3D rock mass to yield to loads that exceed the rock strength, and deform non-linearly to dissipate the excess stresses. This feature is useful for simulation of thick seams, over-stressed pillars, abutments, backfill and creep response. This formulation solves the non-linear problem throughout the rock mass.

## 5.9 Map3D Fault-Slip

**Map3D Fault-Slip** - elastic rock mass and fully plastic fault-slip stress analysis.

This module is used for conducting stress analysis of 3D models. This software is used for civil, geological and mining projects.

Includes the 3D CAD modeller ([Map3D Modeller](#)), results viewer ([Map3D Results Viewer](#)) and the GIS visual database.

The stress analysis utilizes the BEM (boundary element method) and has many features:

- Very large problem sizes. Map3D can conduct stress analysis on models with thousands of excavations (over one million degrees of freedom). This allows for detailed representation of the geometry and eliminates the need to simplify large models (over simplification is a primary source of error in modelling). Mine wide-models can be readily simulated.
- Full 3D complex excavation shapes. As-built detailed models and complex 3D shapes can readily be analyzed. Since the stress analysis is based on the boundary element method (BEM), only the surfaces of the excavations (and other features) need to be specified. There is no need for definition (subdivision into elements) of the pillars between adjacent excavations. Any arbitrary shapes are readily combined into a single large model ready for analysis.
- Multiple elastic zones with different moduli (stiff dykes or soft ore). Map3D is fully capable of incorporating alternate material zones. This makes consideration of stiff or soft rock types easy to consider.
- Zones with different pre-mining stress states.
- Tabular mining with yielding pillars. This approximation is often appropriate for large narrow vein mines.
- Discrete non-planar fault planes that slip and dilate elasto-visco-plastically (including creep). These features are implemented using the displacement discontinuity method. Elasto-visco-plastic flow rules are implemented to accommodate a variety of different types of behaviour. Fault slip analysis for both mining as well as earthquake simulation is readily accommodated.
- Cracks and fractures can be simulated including energy release rate and stress intensity calculations. Fracture propagation can be simulated as a series of discrete steps.
- Multiple mining steps are required to consider effects such as backfill placement or crack propagation. Map3D currently allows for 40 steps. Various materials can be substituted into excavations or fractures at any stage.
- Automatic Boolean intersections allows for excavations, faults and fractures to cross and overlap. Without this capability, modelling of intersecting features would be practically impossible for complex models. Map3D handles these situations with ease.
- Automated discretization. Models can be manually discretized if desired, or this can be left

to the automated routines built into the program. These routines ensure that elements are concentrated only where needed providing consistently high accuracy while optimizing for analysis time.

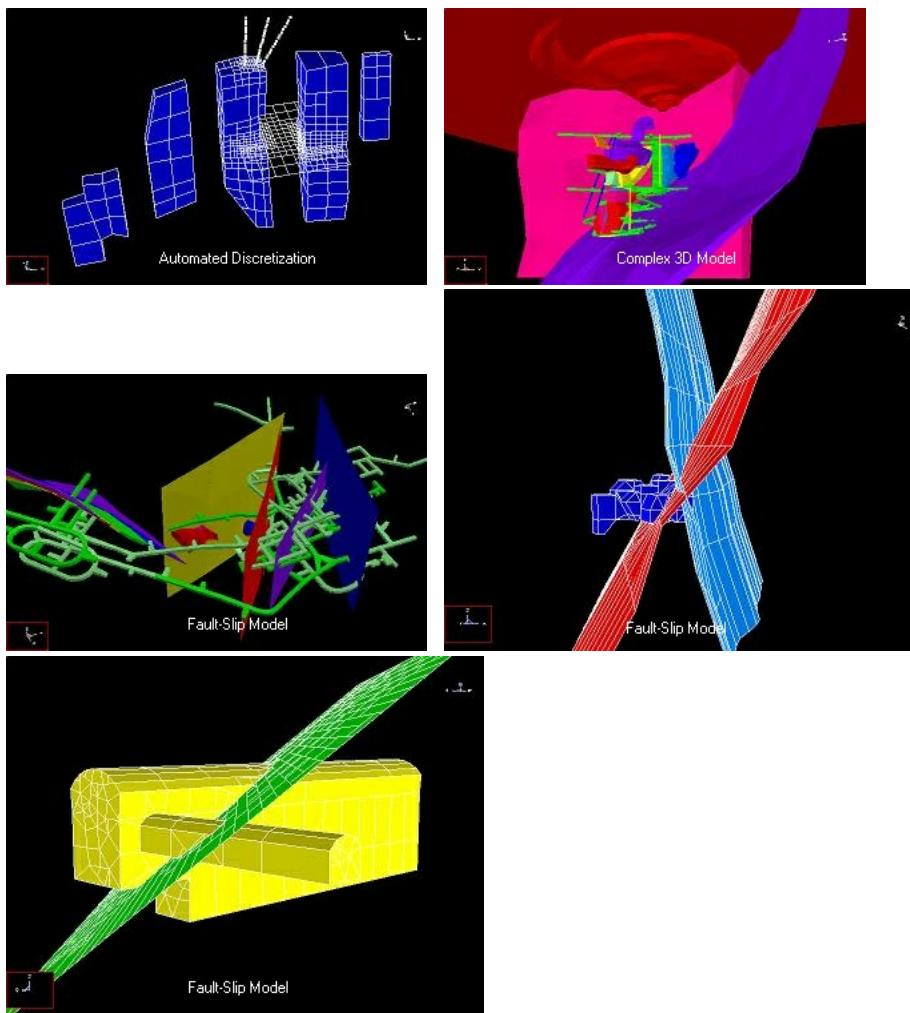

A [demonstration version](#) of Map3D Fault-Slip is available at no charge. All features are available except the user is only permitted to run small size problems. This version is extremely useful for teaching the fundamentals of modelling, visualization and 3D CAD.

[Map3Di Integrated Seismicity](#)

## 5.10 Map3D Modeller

**Map3D Modeller** - 3D CAD and GIS visual database.

This module is used for constructing and visualizing 3D models. This software is used for civil, geological and mining projects.

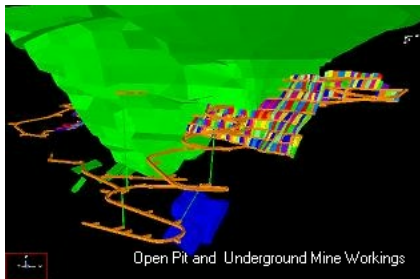
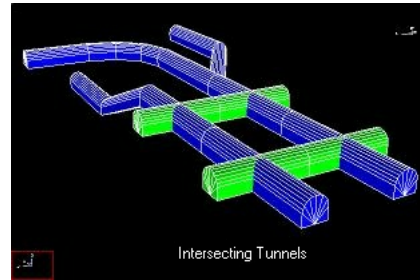
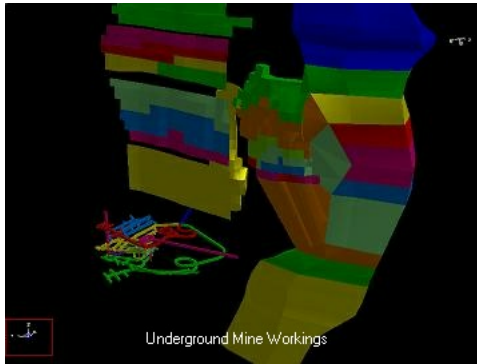

Easy to use 3D CAD (OpenGL based) system includes free-hand sketching, digitizing or object picking to build and edit 5 basic entity types:

- 3D blocks. These entities are used to construct stopes, ore zones, dykes and tunnels. Construction is most easily approached by defining a series of cross-sections or level plans (each can have a different shape and different number of points). Map3D can readily simplify these if desired and then interpolate between the loops to form complex 3D shapes.
- 2D features. These entities are used to construct faults, tabular mining, ground topography and fractures. These features need not be planar. Curved and offset fractures and faults are fully supported.
- Grid planes. Cross-sections can be defined for contouring or simply slicing the model.
- Grid lines. These are particularly useful for representing the location of bore holes and ground support. Instrument locations and orientations are easily identified.
- Construction lines. Simple survey data such as drift centre lines are most easily represented using construction lines. This allows for easy import/export to other CAD packages (full dxf and pnt capability) as well a quick way of displaying line data.
- Light source shaded models. OpenGL light source shading is supported for enhanced model representation.

Includes a full suite of editing functions including copy, move, stretch, flatten, scale, rotate and more. This allows for easy graphical manipulation of the above entities.

The GIS visual database can be used store, analyze and display a database of any desired information including seismic data and geologic information such as grade, rock mass quality etc.

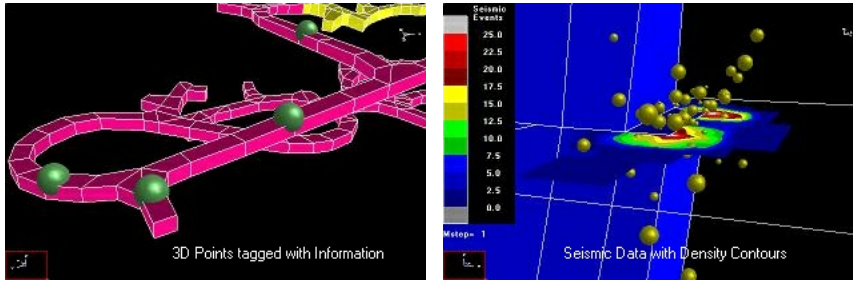

3D points can be tagged with a series of:

- numeric values (e.g. colour, magnitude, orientation, time etc.),
- keywords (for filtering),
- text messages,
- file names (e.g. graphics files, documents, spreadsheets, drawings etc.).

Display of these items can be filtered in various ways. The location of each point can be displayed as colour shaded spheres with size and colour scaled according to various combinations of parameters. Point magnitude density can be contoured on a plane according to user defined density functions. Contour planes can be user defined or fitted using automated linear-regression.

[Map3D Results Viewer](#)

## 5.11 Map3D Results Viewer

**Map3D Results Viewer** - viewing and analysis of stress analysis results.

Includes the GIS visual database but not the CAD system.

- views stress analysis results generated by Map3D stress analysis codes
- displays contours on cutting planes, along lines and at specific points
- user defined contouring functions
- direct export to Excel for plotting x-y graphs
- display of 3D trajectories
- display of all stress, strain, displacement and strength parameters including principal components and resultant values on user defined planes and lines
- export in dxf and pnt format for compatibility with other CAD and display systems
- probability of failure contours
- safety factor contours
- light source shaded models
- topographical contours

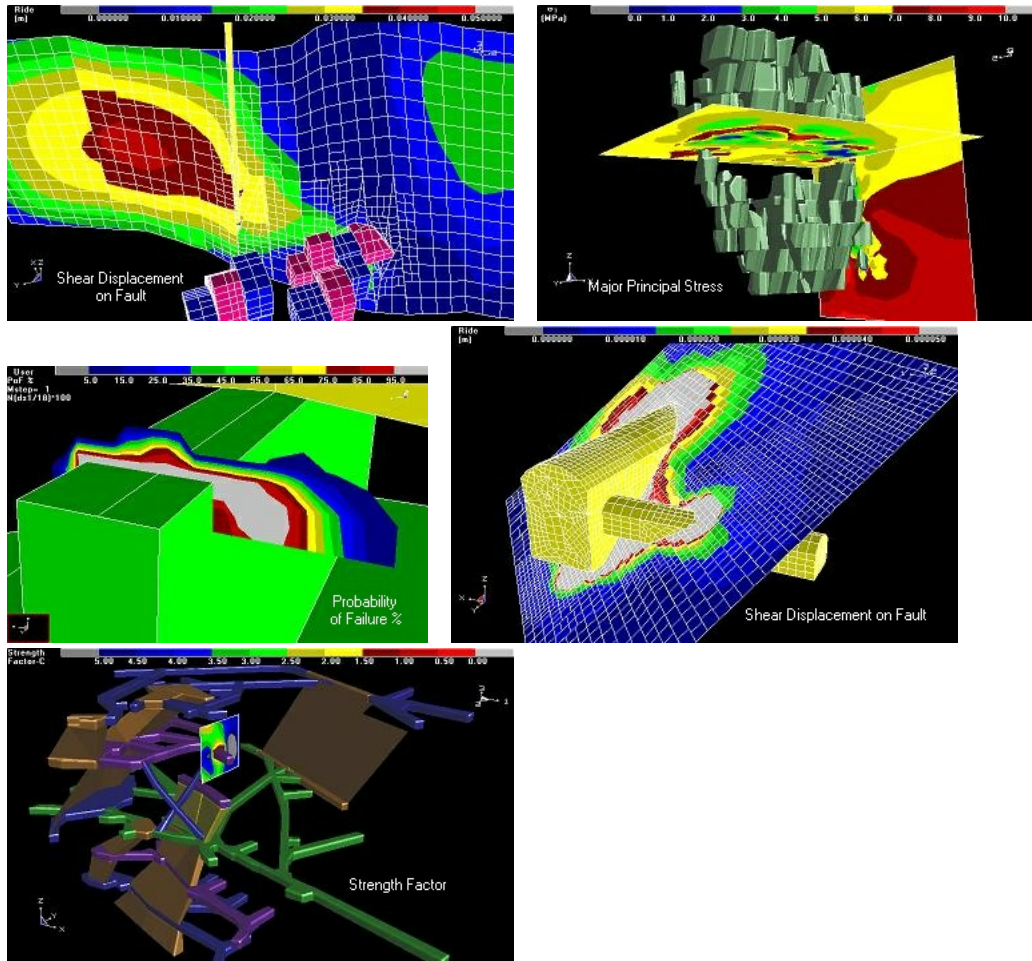

[Map3D Fault-Slip](#)

## 5.12 Map3Di Integrated Seismicity

**Map3Di Integrated Seismicity** - superimpose external field loading effects into the stress analysis.

Includes all capabilities from [Map3D Fault-Slip](#) and adds field loading effects. The field loading effects can be imported from any database of thermal heating, fluid pressure, non-linear behaviour and deformations indicated by seismicity. These effects can be used to characterize 2D and 3D geologic features, accommodate changing lithology and incorporate seismic loading effects into the stress analysis.

Numerical modelling allows one to predict the rock mass response as a result of advancing mining excavations. While the effect of geologic features such as faults or changing lithology can be readily incorporated into the model, often the location, orientation and behavioural properties of such features is uncertain. This can result in modelling results of low reliability and hence of limited use to mine operators. Map3Di allows one to superimpose external field

loading effects into the Map3D model. The field loading can come from thermal heating, fluid pressure, non-linear behaviour, etc. In addition, these can be determined from many forms of in situ monitoring including for example fluid pressures (e.g. well drawdown, dams, hydrofracturing), heating (e.g. natural heating, nuclear waste storage), and deformations (e.g. monitored with extensometers).

Another important source of in situ field loading information comes from seismic activity. By definition, the presence of seismicity indicates that the rock mass is yielding to load and hence deforming in some way. The seismicity could indicate shearing on a fault plane or 3D material non-linearity possibly resulting due to a weak lithological feature. Map3Di allows you to superimpose the deformations indicated by the seismicity onto your Map3D mine model. For example, if your seismicity is telling you that you are getting shearing at some location, then this can be enforced in the model, thereby redistributing the stresses to accommodate this effect.

The concept behind Map3Di is to superimpose some known field loading along with regular modelling features (pre-mining stress, model geometry, dykes, faults, etc.) to provide a composite prediction of the stresses, strain and displacements throughout the rock mass. The integration of numerical modelling with seismic monitoring through the Map3Di boundary element method allows one to superimpose the deformations indicated by the seismicity into your numerical model. This effectively characterizes geologic features and accommodates the effect these have on rock mass response.

The field loading information boils down to specification of: ride and dilation on a segment of a slip plane, and/or deformation of a 3D zone. But where does such information come from:

- Suppose you measure the temperature distribution throughout your mine and you want to apply this field loading to a Map3Di model. This would be applied by subdividing the whole rock mass up into small 3D zones then specifying the temperature in each zone. You would then need to calculate the "free thermal expansion" for each zone. You then simply tell Map3Di to use this field loading. Map3Di conducts the necessary calculations to determine the stress contribution of the integrated field loading.
- Suppose you inject some heavy grout into a fracture, then after this sets, drill some holes to determine the amount of dilation you caused in the fracture, and you want to apply this field loading to a Map3Di model. This would be applied by subdividing the fracture into small planar zones then specifying the dilation in each zone. You then simply tell Map3Di to use this field loading. Map3Di conducts the necessary calculations to determine the stress contribution of the integrated field loading.
- Suppose from your seismicity you determine that portions of your rock mass are deforming and other parts are not. This would be applied by subdividing the whole rock mass up into small 3D zones then calculating the deformation in each zone. You then simply tell Map3Di to use this field loading. Map3Di conducts the necessary calculations to determine the stress contribution of the integrated field loading.

Note that the Map3Di model can contain all of the regular features including excavations, stiff dykes, faults etc. The effects of the field loading and all of these other features will be superimposed to provide a final composite prediction of the stresses, strains and displacements throughout the rock mass.

How does Map3Di assist us in overcoming the shortcomings in applying Terzaghi's Observational Approach to Design? There are many possible benefits from adopting this

approach:

- First let's recognize that we intend to apply known field loading conditions measured from field data (seismicity, temperature, fluid pressures or deformations). This in itself can be considered to be a calibration or fine-tuning exercise, as opposed to making a prediction. We are literally adding information to our model.
- The wealth of information that comes from seismic monitoring is enormous. Seismic monitoring provides the volume and spatial distribution of information on the rock mass response that can be obtained in no other way at reasonable cost. Map3Di provides a mechanism to directly use this information for model calibration. Owing to the real-time nature of seismicity, it becomes practical to traverse the mine/monitor/redesign loop for every increment of mining. Thus instead of spending years making visual observations to develop a history of rock mass response, there is potential to calibrate your model much more quickly.
- Perhaps the most important part of this is that it provides the possibility of adapting to changing rock mass conditions in real-time. This allows one to recognize and adapt to rapidly changing local conditions such as lithology or jointing. You can update your model calibration as conditions change. This has the potential to significantly improve the reliability of predictions.
- Finally, by incorporating for example some fault slip indicated by seismicity, you have in fact characterized the effect of that fault slip and incorporated its effect into your model. For example, if your seismicity is telling you that you are getting shearing at some location, then this can be enforced in the model, thereby redistributing the stresses to accommodate this exact effect.

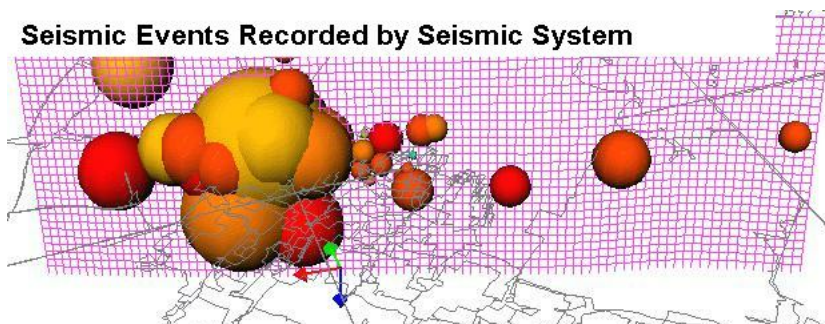
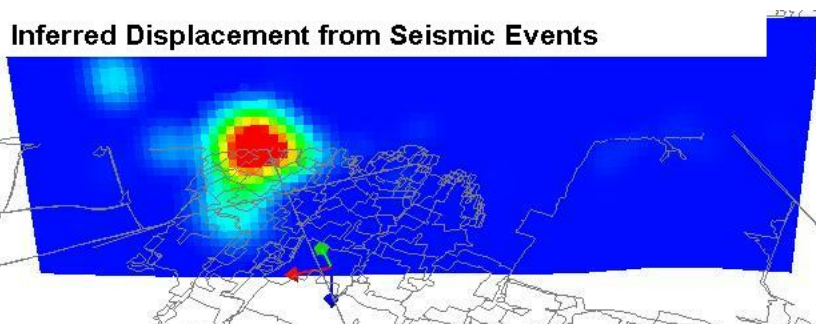



### Shear Displacement from Map3d Model

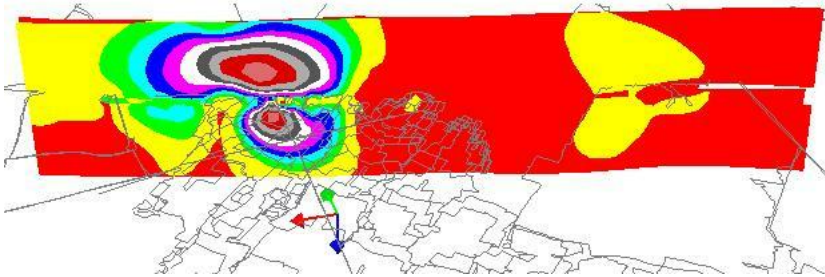

[Map3D Thermal-Fluid Flow](#)

## 5.13 Map3D Thermal-Fluid Flow

**Map3D Thermal-Fluid Flow** - thermal stress - fluid flow analysis.

Includes all capabilities from [Map3D Fault-Slip](#) and adds simultaneous solution of steady state thermal stress - fluid flow. The program is set up so that the user need only specify the temperature/head boundary conditions, then the thermal stress problem is solved simultaneously. This feature is useful for simulation of heating/cooling effects and drained/undrained response.

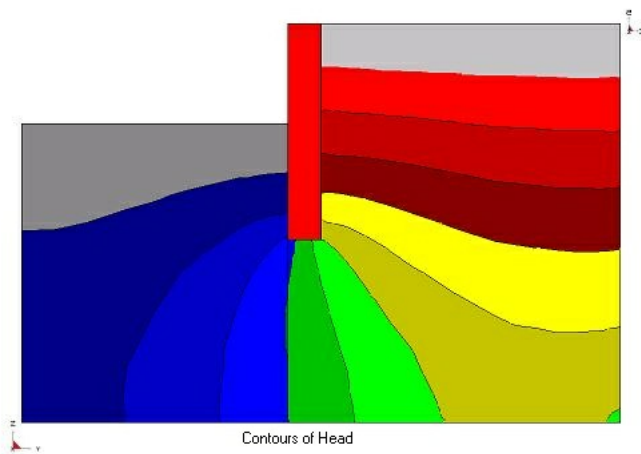

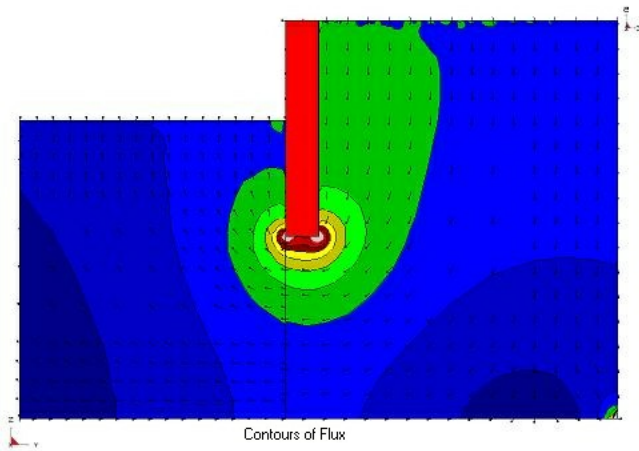

[Map3D Non-Linear](#)

## 5.14 Map3D Non-Linear

**Map3D Non-Linear** - non-linear rock mass response.

Includes all capabilities from [Map3D Fault-Slip](#) and adds the capability for the 3D rock mass to yield to loads that exceed the rock strength, and deform non-linearly to dissipate the excess stresses. This feature is useful for simulation of thick seams, over-stressed pillars, abutments, backfill and creep response. This formulation solves the non-linear problem on the surface of the boundary elements and interpolates these effects between these boundaries. This represents a first approximation to inelastic modelling that boasts the advantage of large problem sizes and very fast execution speeds.

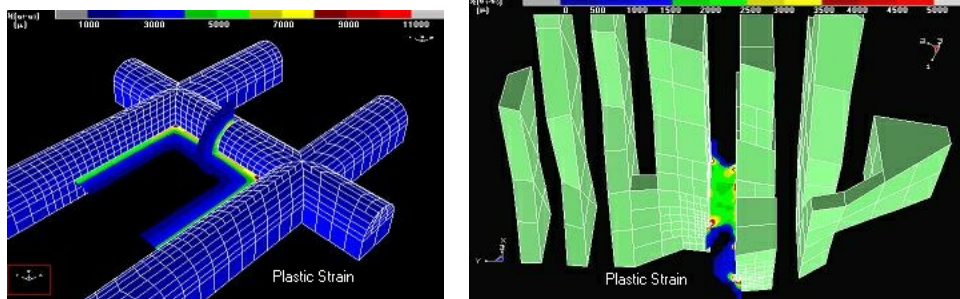

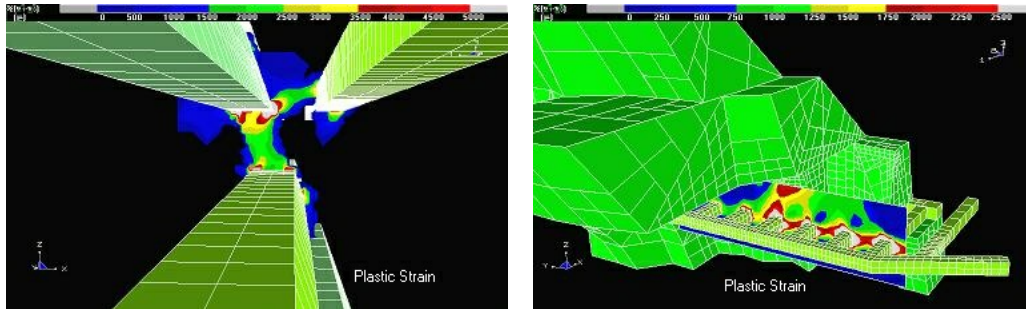

### [Map3D Visco-Plastic](#)

## 5.15 Map3D Visco-Plastic

**Map3D Visco-Plastic** - 3D elasto-visco-plastic rock mass response (still under development - not available commercially at this time).

Includes all capabilities from [Map3D Fault-Slip](#) and adds the capability for the 3D rock mass to behave elasto-visco-plastically. This model features a full solution of the non-associated incremental plasticity equations and adds the capability for the 3D rock mass to yield to loads that exceed the rock strength, and deform non-linearly to dissipate the excess stresses. This simulation capability provides the large displacements required to simulate ground support and backfill interaction studies. This feature is useful for simulation of thick seams, over-stressed pillars, abutments, backfill and creep response. This formulation solves the non-linear problem throughout specified zones in the rock mass.

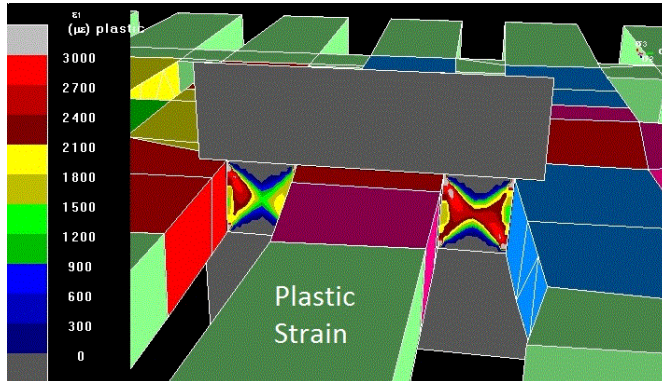

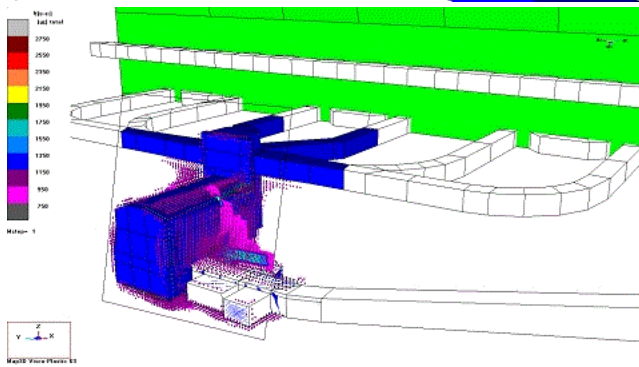
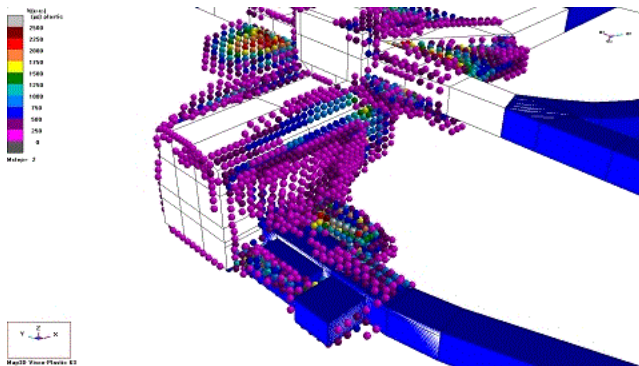
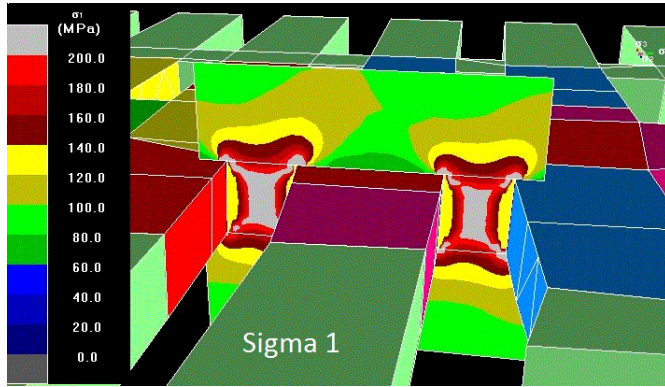

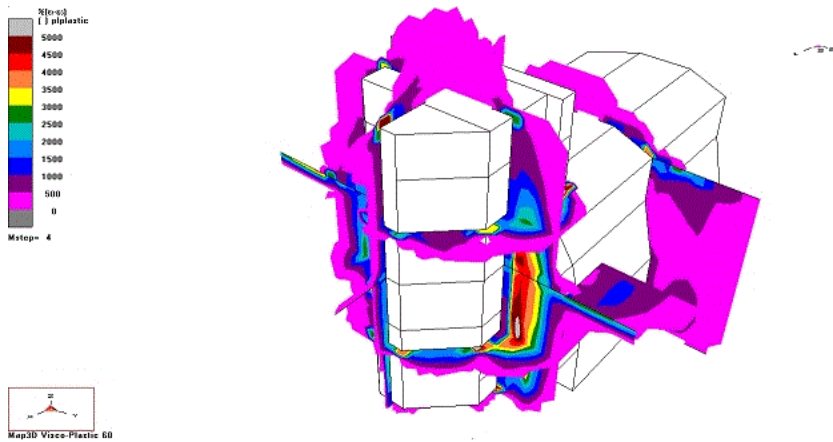
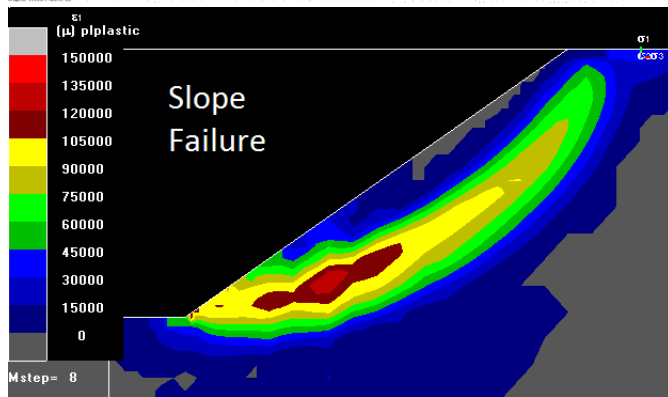
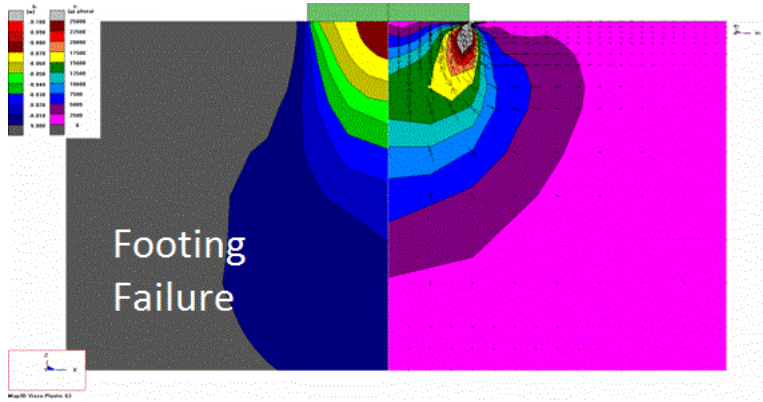

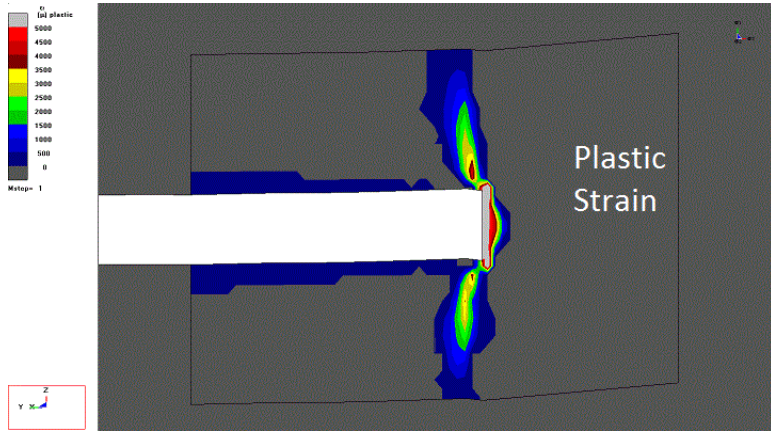

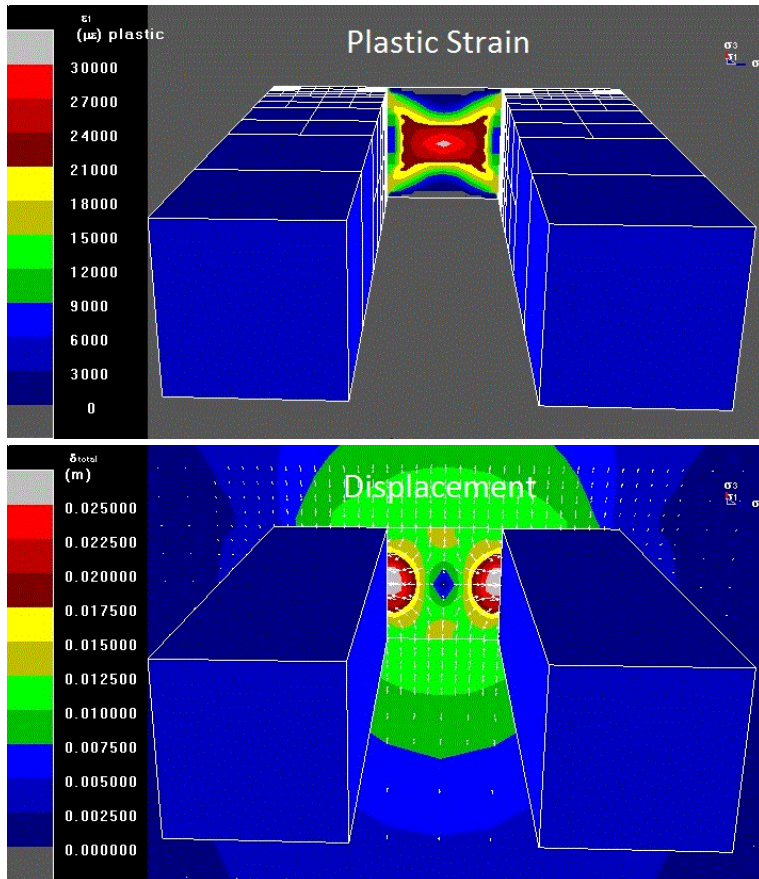

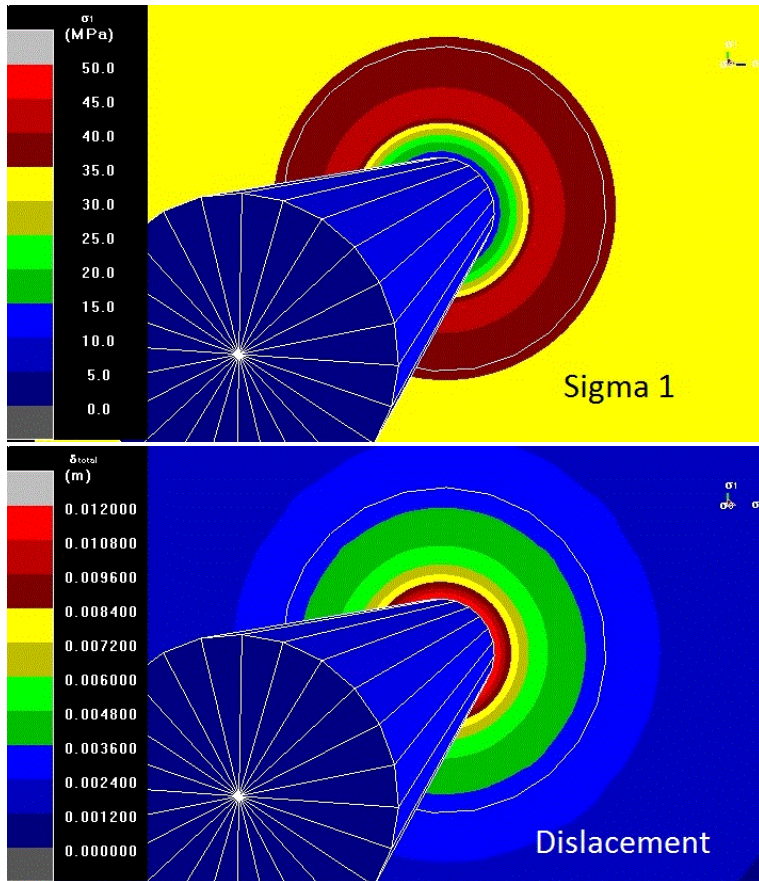

[Map3D Overview](#)

## 5.16 Model Building Tutorials

[Freehand Sketching - Room and Pillar Mining](#)

[Bulk Mining Example](#)

[Tabular Mining Example](#)

[DDLoop Pillar Example](#)

[FFLoop Drift Example](#)

[FFLoop Stope Example](#)



## 5.17 Plot > Stress

Activate the stress toolbar – after Map3D BEM analysis.



This toolbar is meant to provide quick access to stress components.

	<a href="#">Plot &gt; Stress &gt; S1</a>	Major Principal Stress $\sigma_1$
	<a href="#">Plot &gt; Stress &gt; S2</a>	Intermediate Principal Stress $\sigma_2$
	<a href="#">Plot &gt; Stress &gt; S3</a>	Minor Principal Stress $\sigma_3$
	<a href="#">Plot &gt; Stress &gt; Tmax</a>	Maximum Shear Stress $\frac{1}{2}(\sigma_1 - \sigma_3)$
	<a href="#">Plot &gt; Stress &gt; Tip</a>	In-Plane Shear Stress $\tau_{ip}$
	<a href="#">Plot &gt; Stress &gt; Sip</a>	In-Plane Normal Stress $\sigma_{ip}$
	<a href="#">Plot &gt; Stress &gt; S1i</a>	In-Plane Maximum Stress $\sigma_{1i}$
	<a href="#">Plot &gt; Stress &gt; S3i</a>	In-Plane Minimum Stress $\sigma_{3i}$
	<a href="#">Plot &gt; Stress &gt; Tub</a>	Ubiquitous-Plane Shear Stress $\tau_{ub}$
	<a href="#">Plot &gt; Stress &gt; Sub</a>	Ubiquitous-Plane Normal Stress $\sigma_{ub}$
	<a href="#">Plot &gt; Stress &gt; S1u</a>	Ubiquitous-Plane Maximum Stress $\sigma_{1u}$
	<a href="#">Plot &gt; Stress &gt; S3u</a>	Ubiquitous-Plane Minimum Stress $\sigma_{3u}$
	<a href="#">Plot &gt; Stress &gt; Toct</a>	Octahedral Shear Stress $\tau_{oct} = \frac{1}{3} [(\sigma_1 - \sigma_2)^2 + (\sigma_2 - \sigma_3)^2 + (\sigma_3 - \sigma_1)^2]^{\frac{1}{2}}$
	<a href="#">Plot &gt; Stress &gt; Smean</a>	Mean Stress $\sigma_{mean} = \frac{1}{3} (\sigma_1 + \sigma_2 + \sigma_3)$
	<a href="#">Plot &gt; Stress &gt; Sxx</a>	Cartesian Stress Component $\sigma_{xx}$
	<a href="#">Plot &gt; Stress &gt; Syy</a>	Cartesian Stress Component $\sigma_{yy}$
	<a href="#">Plot &gt; Stress &gt; Szz</a>	Cartesian Stress Component $\sigma_{zz}$
	<a href="#">Plot &gt; Stress &gt; Txy</a>	Cartesian Stress Component $\tau_{xy}$
	<a href="#">Plot &gt; Stress &gt; Tyz</a>	Cartesian Stress Component $\tau_{yz}$
	<a href="#">Plot &gt; Stress &gt; Txz</a>	Cartesian Stress Component $\tau_{xz}$
	<a href="#">Plot &gt; Stress &gt; Value &gt; Seff</a>	Effective Stress $\sigma_{eff}$
	<a href="#">Plot &gt; Stress &gt; Value &gt; Stotal</a>	Total Stress $\sigma_{total}$

Notes:

The stress toolbar can only be activated after the model building - CAD Stage

[Map3D Analysis Stages](#)

Any of these components can be added to the contour toolbar if desired

[Tools > Configure Contouring Toolbar](#)

## 5.18 Plot > Failure Modes

Activate the strength factors toolbar – after Map3D BEM analysis.

This toolbar is meant to provide quick access to the failure mode plots.

### Rock mass Strength

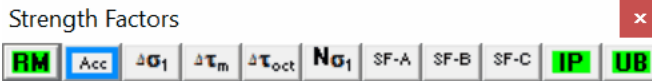

**RM** [Plot > Strength Factors > Strength Parameters](#) parameters. modifies the 3D Mohr-Coulomb, Hoek-Brown and Drucker-Prager strength

**SF-A** [Plot > Strength Factors > SF-A](#) contours the strength/stress ratio using method A

**SF-B** [Plot > Strength Factors > SF-B](#) contours the strength/stress ratio using method B

**SF-C** [Plot > Strength Factors > SF-C](#) contours the strength/stress ratio using method C

**SF/A** [Plot > Strength Factors > SF/A](#) contours the stress/strength ratio using method A

**SF/B** [Plot > Strength Factors > SF/B](#) contours the stress/strength ratio using method B

**SF/C** [Plot > Strength Factors > SF/C](#) contours the stress/strength ratio using method C

**Δσ<sub>1</sub>** [Plot > Strength Factors > dS1](#) contours the excess major principal stress  $\Delta\sigma_1$

**Δτ<sub>m</sub>** [Plot > Strength Factors > dTmax](#) contours the excess maximum shear stress  $\Delta\tau_{max} = \Delta\frac{1}{2} (\sigma_1 - \sigma_3)$

**Δτ<sub>oct</sub>** [Plot > Strength Factors > dToct](#) contours the excess octahedral shear stress  $\Delta\tau_{oct} = \Delta\frac{1}{3} [(\sigma_1 - \sigma_2)^2 + (\sigma_2 - \sigma_3)^2 + (\sigma_3 - \sigma_1)^2]^{\frac{1}{2}}$

**Nσ<sub>1</sub>** [Plot > Strength Factors > Ns1](#) contours the probability of failure calculated as  $N(\Delta\sigma_1/s)$  where  $s$  is the standard deviation.

**Acc** [Plot > Strength Factors > Acc](#) contours the accumulated damage.

## In-Plane Strength



**IP** [Plot > Strength Factors > In-plane parameters](#) modifies the Mohr-Coulomb in-plane strength parameters

**SF-ip** [Plot > Strength Factors > SF-ip](#) contours the strength/stress ratio using in-plane stresses

**SF/ip** [Plot > Strength Factors > SF/ip](#) contours the stress/strength ratio using in-plane stresses

**Δτ<sub>ip</sub>** [Plot > Strength Factors > dTip](#) contours the excess in-plane shear stress  $\Delta\tau_{ip}$

**Nτ<sub>ip</sub>** [Plot > Strength Factors > NTip](#) contours the probability of failure calculated as  $N(\Delta\tau_{ip}/s)$  where  $s$  is the standard deviation.

**Acc** [Plot > Strength Factors > Acc](#) contours the accumulated damage.

## Ubiquitous-Plane Strength

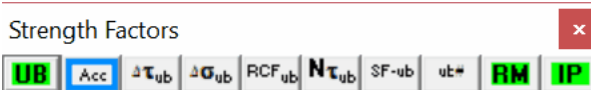



**UB** [Plot > Strength Factors > Ubiquitous Parameters](#) modifies the Mohr-Coulomb ubiquitous -

plane strength parameters

 [Plot > Strength Factors > SF-ub](#) contours the strength/stress ratio using ubiquitous-plane stresses

 [Plot > Strength Factors > SF/ub](#) contours the stress/strength ratio using ubiquitous-plane stresses

 [Plot > Strength Factors > dTub](#) contours the excess ubiquitous-plane shear stress  $\Delta\tau_{ub}$

 [Plot > Strength Factors > NTub](#) contours the probability of failure calculated as  $N(\Delta\tau_{ip}/s)$  where  $s$  is the standard deviation.

 [Plot > Strength Factors > Acc](#) contours the accumulated damage.

**Notes:**

The strength factors toolbar can only be activated after the model building - CAD Stage

[Map3D Analysis Stages](#)

Any of these components can be added to the contour toolbar if desired





 [Tools > Configure Contouring Toolbar](#)

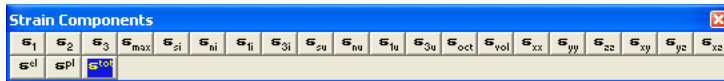



## 5.19 Plot > Strain





Activate the strain toolbar – after Map3D BEM analysis.





This toolbar is meant to provide quick access to strain components.

-  [Plot > Strain > E1](#) Major Principal Strain  $\epsilon_1$
-  [Plot > Strain > E2](#) Intermediate Principal Strain  $\epsilon_2$
-  [Plot > Strain > E3](#) Minor Principal Strain  $\epsilon_3$
-  [Plot > Strain > Emax](#) Maximum Shear Strain  $\epsilon_{max} = \frac{1}{2}(\epsilon_3 - \epsilon_1)$

-  [Plot > Strain > Esi](#) In-plane Maximum Shear Strain  $\epsilon_{si}$
-  [Plot > Strain > Eni](#) In-plane Normal Strain  $\epsilon_{ni}$
-  [Plot > Strain > E1i](#) In-plane Maximum Strain  $\epsilon_{1i}$
-  [Plot > Strain > E3i](#) In-plane Maximum Strain  $\epsilon_{3i}$

-  [Plot > Strain > Esu](#) Ubiquitous-plane Maximum Shear Strain  $\epsilon_{su}$
-  [Plot > Strain > Enu](#) Ubiquitous-plane Normal Strain  $\epsilon_{nu}$
-  [Plot > Strain > E1u](#) Ubiquitous-plane Maximum Strain  $\epsilon_{1u}$
-  [Plot > Strain > E3u](#) Ubiquitous-plane Maximum Strain  $\epsilon_{3u}$

-  [Plot > Strain > Eoct](#) Octahedral Shear Strain  $\epsilon_{oct} = \frac{1}{3}[(\epsilon_1 - \epsilon_2)^2 + (\epsilon_2 - \epsilon_3)^2 + (\epsilon_3 - \epsilon_1)^2]^{\frac{1}{2}}$
-  [Plot > Strain > Evol](#) Volumetric Strain  $\epsilon_{vol} = (\epsilon_1 + \epsilon_2 + \epsilon_3)$

-  [Plot > Strain > Exx](#) Cartesian Strain Component  $\epsilon_{xx}$
-  [Plot > Strain > Eyy](#) Cartesian Strain Component  $\epsilon_{yy}$
-  [Plot > Strain > Ezz](#) Cartesian Strain Component  $\epsilon_{zz}$
-  [Plot > Strain > Exy](#) Cartesian Strain Component  $\epsilon_{xy}$

-  [Plot > Strain > Eyz](#) Cartesian Strain Component  $\epsilon_{yz}$
-  [Plot > Strain > Exz](#) Cartesian Strain Component  $\epsilon_{xz}$
-  [Plot > Strain > Value > Elastic](#)  $\epsilon_{elastic}$
-  [Plot > Strain > Value > Plastic](#)  $\epsilon_{plastic}$
-  [Plot > Strain > Value > Total](#)  $\epsilon_{total}$

Notes:

The strain toolbar can only be activated after the model building - CAD Stage

[Map3D Analysis Stages](#).

Any of these components can be added to the contour toolbar if desired

















 [Tools > Configure Contouring Toolbar](#)

## 5.20 Plot > Surface Components

Activate the surface components toolbar – after Map3D BEM analysis.



This toolbar is meant to provide quick access to the surface component plots.

-  [Plot > Surface Components > Serr](#) Stress Error
-  [Plot > Surface Components > Ferr](#) Failure Error
-  [Plot > Surface Components > Ts](#) Shear Stress
-  [Plot > Surface Components > Sn](#) Normal Stress
-  [Plot > Surface Components > Es](#) Shear Strain
-  [Plot > Surface Components > En](#) Normal Strain
-  [Plot > Surface Components > Ds](#) Shear Displacement (Ride)
-  [Plot > Surface Components > Dn](#) Normal Displacement (Closure)
-  [Plot > Surface Components > Strength/Stress](#)
-  [Plot > Surface Components > dTs](#) Excess Shear Stress
-  [Plot > Surface Components > dEs](#) Incremental Shear Strain
-  [Plot > Surface Components > dTs / dEs](#) Stress/Strain rate
-  [Plot > Surface Components > Temperature/Head](#)
-  [Plot > Surface Components > qn](#) Normal Flux
-  [Plot > Surface Components > Value > Elastic](#)
-  [Plot > Surface Components > Value > Plastic](#)
-  [Plot > Surface Components > Value > Total](#)

Notes:

The surface components toolbar can only be activated after the model building - CAD Stage

[Map3D Analysis Stages](#)

Any of these components can be added to the contour toolbar if desired

 [Tools > Configure Contouring Toolbar](#)

## 5.21 Stress Orientation Icon

The orientation of the far field principal stress state is indicated by the stress orientation icon located at the upper right corner of the display.



In the view above, the  $\sigma_1$  axis points mostly into the screen and a bit to the right, the  $\sigma_2$  axis points mostly to the right and a bit out of the screen, and the  $\sigma_3$  axis points straight up. Note that the backside of the icon is shaded in blue.



In the view above, the  $\sigma_1$  axis points mostly to the right and a bit into the screen, the  $\sigma_2$  axis points mostly out of the screen and a bit to the right, and the  $\sigma_3$  axis points straight up. Note that the inside of the icon is shaded in red.

Note that the length of the axes are scaled according to the magnitude of the principal stress components.

## 5.22 Translating the Model

**Translating the Model** - The model can be translated by holding down the right mouse button and wait for the drag mouse pointer  to appear, then drag out a pan vector. Dragging towards the top or bottom translates the model up or down. Dragging towards the left or right translates the model left or right.

**Zooming the Model** - The model can be zoomed by rotating the mouse wheel, or holding down both the left and right mouse buttons and wait for the drag mouse pointer  to appear, then dragging out a zoom factor. Dragging towards the top zooms the model out. Dragging towards the bottom magnifies the model.

The model can also be translated and zoomed using the translation toolbar or keyboard keys

[Tools > Translation Toolbar](#)

Related Topics:

[Rotating the model](#)

[Selecting special view positions](#)

You can adjust the drag wait time using

[Tools > Drag Wait Time](#)

## 5.23 View > Render > Discretize

Toggles the display of discretized and non-discretized views of the model.

The non-discretized view simply shows the model surfaces.

When checked, the discretized view shows how all model surfaces have been subdivided into boundary elements. The element discretization can only be viewed after the discretization analysis

[Analysis > Discretization](#).

## 5.24 Visualization > Make Point

Creates a new visualization point. Refer to [Visualization](#) for a description of the visualization routines available in Map3D.

Visualization points can be displayed as light source shaded spheres with diameter and/or colour varying as magnitude, and contoured on a plane to display density etc.

Each point can be tagged with a series of:

- numeric values (e.g. colour, magnitude, orientation etc.)
- text messages
- file names (e.g. graphics files, documents, spreadsheets etc.)

Upon left clicking on a point, the location, magnitude and text message are displayed on the status bar.

Right clicking on a point activates the [Visual Database](#). This feature can be used to display a database of useful geologic information such as grade, rock mass quality etc.

Upon activating the feature, the user will be prompted to supply the coordinates of the new visualization point.

Note that if a visualization file is already active, this new point will be added to the file.

If there is no active visualization file the user will be prompted open one and this new point will be added to the file.

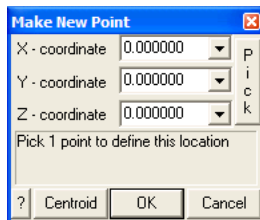

**X, Y and Z coordinate** - specifies the coordinates of the visualization point.

**Pick** - activates the cursor cross-hairs allowing interactive selection of the coordinates from the model.

To assist in visually selecting points from the model, all snap functions are available.

 [CAD > Snap](#)

Once selected, the coordinates of the visualization point are displayed in the dialogue box.

**Centroid** - activates the cursor so the user can select an entity from the model. The coordinates will be calculated at the centre of the selected entity.

**OK** - completes editing of the coordinates and creates and displays the visualization point.

Once the visualization point is created, the user can now right click on the point to add text messages and/or file names.

- The text message and file name are displayed in the status bar across the bottom of the screen by picking an event with the left mouse button.
- They can also be edited by picking an event with the right mouse button.
- Picking with the right mouse button also allows for display of the file if the file name has been associated with an application (refer to Windows documentation on how to "Associate a file with a program").

## 5.25 Global Transform Z+ up

The orientation of the model is indicated by an orientation icon located at the bottom left corner of the display. This icon indicates the direction of the axes (X for East, Y for North and Z up).



In the view above, the Y-axis points mostly into the screen and a bit to the right, the X-axis points mostly to the right and a bit out of the screen, and the Z-axis points straight up. Note that the backside of the icon is shaded in blue.



In the view above, the Y-axis points mostly to the right and a bit into the screen, the X-axis points mostly out of the screen and a bit to the right, and the Z-axis points straight up. Note that the inside of the icon is shaded in red.

There are three selectable rotation models:

1. Rotations can be applied to the current geometry. This mode allows for a non-horizontal horizons
2. Rotations can be applied such that the horizon always remains horizontal assuming the Z+ axis is up (Tools > Global Transform Z+ up).  
This causes the mouse rotation to occur in the opposite way to Tools > Global Transform Z- up.
3. Rotations can be applied such that the horizon always remains horizontal assuming the Z- axis is up (Tools > Global Transform Z- up).  
This causes the mouse rotation to occur in the opposite way to Tools > Global Transform Z+ up.

The model can be rotated by holding down the left mouse button and wait for the drag mouse pointer  to appear, then drag the orientation icon around to the desired position. Dragging towards the top or bottom rotates the model up or down. Near the bottom of the screen, dragging towards the left or right rotates the model left or right. Near the top of the screen, dragging towards the left or right rotates the model counter clockwise or clockwise. This operation can be customized using [Tools > Rotation Toolbar](#).

The model can also be rotated using touch screen controls by dragging either 1 or 2 fingers across the screen, and pinching for zoom. This operation can be customized using [Tools > Rotation Toolbar](#).

Notes:

Before rotating the model, you should set the desired centre of rotation

 [View > Centre](#)

You can adjust the drag wait time using

[Tools > Drag Wait Time](#)

Rotation and translation operations can be repeated automatically by typing **n#** before selecting the operation. For example to produce an animated display of a stress plot, specify

 [Plot > Options > Persist](#)

 [Plot > Stress > Sigma:1](#)

 [View > Rotation Increment > 10](#)

type in **35#** from the keyboard

 select rotate right (either from the rotation toolbar or the PageDown key)

Press the Esc key to cancel the animation.

Entering **0#** will repeat the operation indefinitely. Press the escape key to stop.

Related Topics:

[Translating the model](#)

[Selecting special view positions](#)

## 5.26 Global Transform Z- up\_2

The orientation of the model is indicated by an orientation icon located at the bottom left corner of the display. This icon indicates the direction of the axes (X for East, Y for North and Z up).



In the view above, the Y-axis points mostly into the screen and a bit to the right, the X-axis points mostly to the right and a bit out of the screen, and the Z-axis points straight up. Note that the backside of the icon is shaded in blue.



In the view above, the Y-axis points mostly to the right and a bit into the screen, the X-axis points mostly out of the screen and a bit to the right, and the Z-axis points straight up. Note that the inside of the icon is shaded in red.

There are three selectable rotation models:

1. Rotations can be applied to the current geometry. This mode allows for a non-horizontal horizons
2. Rotations can be applied such that the horizon always remains horizontal assuming the Z+ axis is up (Tools > Global Transform Z+ up).  
This causes the mouse rotation to occur in the opposite way to Tools > Global Transform Z- up.
3. Rotations can be applied such that the horizon always remains horizontal assuming the Z- axis is up (Tools > Global Transform Z- up).  
This causes the mouse rotation to occur in the opposite way to Tools > Global Transform Z+ up.



The model can be rotated by holding down the left mouse button and wait for the drag mouse pointer  to appear, then drag the orientation icon around to the desired position. Dragging towards the top or bottom rotates the model up or down. Near the bottom of the screen, dragging towards the left or right rotates the model left or right. Near the top of the screen, dragging towards the left or right rotates the model counter clockwise or clockwise.

The model can be rotated by using the rotation toolbar or keyboard keys

[Tools > Rotation Toolbar](#).

Notes:

Before rotating the model, you should set the desired centre of rotation

 [View > Centre](#)

You can adjust the drag wait time using

[Tools > Drag Wait Time](#)

Rotation and translation operations can be repeated automatically by typing `n#` before selecting the operation. For example to produce an animated display of a stress plot, specify

 [Plot > Options > Persist](#)

 [Plot > Stress > Sigma:1](#)

 [View > Rotation Increment > 10](#)

type in `35#` from the keyboard

 select rotate right (either from the rotation toolbar or the PageDown key)

Press the Esc key to cancel the animation.

Entering `0#` will repeat the operation indefinitely. Press the escape key to stop.

Related Topics:

[Translating the model](#)

[Selecting special view positions](#)

# Index

## - 0 -

001 002 ... files 404, 478

## - 3 -

3D excavation shapes 27, 29, 30

## - A -

Aborting a Map3D analysis 362

About Map3D 2

Absolute strain 178, 233

Absolute stress 170, 234

Accuracy 44, 241, 294, 363, 380

AG - grid spacing 44, 234, 235, 236, 241, 294, 363

AL - element size 44, 234, 235, 241, 294, 363

Alternate material zones 30

Analysis dialogue box 140, 241, 257, 294, 362, 363, 364, 365, 385, 386

Analysis Options dialogue box 258, 366, 367, 368, 369, 371, 373, 376, 380, 381, 382, 383, 384

Analysis results 139, 140, 141, 152, 404, 417, 478

Analysis time 44, 241, 294, 363

Animation 150, 401

Applications of Map3D 12

As-built models 27

Automated discretization 44, 234, 235, 236, 241, 294, 363

Average value of contour points 249

## - B -

Backfilling 30, 33, 376, 384

Batching analyses 367

BEM analysis 249, 301, 337, 362, 363, 366, 367, 369, 371, 373, 376, 380, 381, 382, 383, 384, 385, 386, 454, 473, 475, 476

Bitmap dump of the screen 141, 142, 150, 151, 401

Block models 29, 30

BMP 141, 142, 150, 401

Boolean intersections 368

Boundary Element Method 13, 14, 376, 380, 384, 455

Build toolbar 260, 263, 269, 276, 277, 279, 280, 281, 283, 284, 339, 389, 400

Building 3D FF blocks 260, 263, 269, 280, 281, 283, 284, 302, 306, 308, 309, 311, 313, 315, 317, 318, 320, 321, 322, 324, 327, 329

Building construction lines 279, 280, 281, 283, 284, 393

Building DD planes 260, 263, 269, 280, 281, 283, 284, 302, 306, 308, 309, 311, 313, 315, 317, 318, 320, 321, 322, 324, 327, 329

Building field point grid lines 276, 277

Building field point grid planes 276, 277, 280, 281, 283, 284, 389, 391

Building field point lines planes 280, 281, 283, 284

Bulk mining - Model building tutorial 76

## - C -

CAD 331, 332, 333, 334

CAD > Build 260, 263, 269, 276, 277, 279, 280, 281, 283, 284

CAD > Build menu 389, 400

CAD > Edit 302, 306, 308, 309, 311, 313, 315, 317, 318, 320, 321, 322, 324, 327, 329

CAD > Edit menu 390, 391, 393

CAD > Properties 241, 249, 294, 301

CAD > Properties menu 245, 246, 298, 299

CAD > Propertiesu 245, 298

CAD > Snap 285, 286, 287, 288, 289, 290, 291, 292

CAD > Snap menu 390

CAD menu 237, 330

CAD toolbar 339, 340, 390, 400

Cartesian strain 177

Cartesian stress 169

Clearing construction line data 137

Clearing model data 134

Closure and overlap checking 368

Coefficient matrix 371, 381, 382, 384

Common problems when model Building 39  
 Conclude the current analysis 385, 386  
 Conducting a BEM stress analysis 363  
 Conducting a Map3D analysis 257  
 Configuring toolbars 160, 336, 337, 338, 339, 340  
 Console mode 367  
 Construction line data 137, 138, 139, 402, 404  
 Contact and intersection analysis 365  
 Contour plot options 237  
 Contour range 236  
 Contouring toolbar 336, 337, 473, 475, 476  
 Copying model data 308  
 Creep elasto-viscoplastic 369  
 Custom button font 342, 343  
 Custom colours 340, 341, 342

## - D -

DD plane thickness 391  
 DD planes 27, 35, 36  
 depth buffer 343, 344, 345  
 Deswick 404  
 Digitizer support 331, 396  
 Discretization analysis 363, 381, 454  
 Discretization and Lumping 44, 234, 235, 236, 241, 294, 363  
 Discretized view  
   display of 478  
 Discretizing a model 363  
 Disk performance test 345  
 Disk space requirements 44, 241, 294, 363, 381  
 Displacement components 178  
 Displacement discontinuity elements 27, 35, 36  
 Displacement toolbar 178  
 Display a saved screen image 150, 151, 401  
 Divergent solutions 44, 234, 235, 241, 294, 363  
 DOC - matrix lumping 44, 234, 235, 241, 294, 363  
 DOE - element lumping 44, 241, 294, 363  
 DOG - grid lumping 44, 241, 294, 363  
 DOL - solution accuracy 44, 234, 235, 236, 241, 294, 363

DON - matrix conditioning 44, 234, 235, 241, 294, 363  
 DOR - element aspect ratio 44, 241, 294, 363  
 Drag rotation of the model 335, 479, 480  
 Drag translation of the model 335, 477  
 Drag zooming the model 335, 477  
 Drucker-Prager in 3D FF Blocks 185, 189, 191, 194, 195, 197, 200, 202, 204, 426  
 Dump analysis results 143, 147  
 Dump the screen image 141, 142, 143, 401  
 DXF construction line file format 404  
 DXF dump of the screen 142  
 DXF model file format 404, 418  
 DXF screen image file format 142

## - E -

Edit toolbar 302, 306, 308, 309, 311, 313, 315, 317, 318, 320, 321, 322, 324, 327, 329, 339, 390, 391, 393, 394, 395  
 Editing model data 302, 335, 390, 391, 393, 394, 395  
 Effective stress 169  
 Elastic strain 178, 233  
 Elasto-viscoplastic creep 369  
 Element lumping 44, 234, 235, 241, 294, 363  
 Element size 44, 234, 235, 241, 294, 363  
 Energy release rate calculation 376  
 Erasing model data 306  
 ESS 164, 165, 166, 167  
 EVP files 346  
 Excess stress 185, 189, 191, 194, 195, 197, 200, 202, 204, 207, 209, 210, 211, 213, 216, 219, 419, 424, 426, 428, 433, 448, 473  
 Expansion coefficient and conductivity 453  
 Extruding planes into blocks 281

## - F -

Failure criterion 185, 189, 191, 194, 195, 197, 200, 202, 204, 207, 209, 210, 211, 213, 216, 219, 419, 424, 426, 428, 433, 448, 473  
 Far field stress state specification 397, 399  
 Fault planes 36

Fault-Gouge in DD Planes 207, 209, 210, 211, 213, 216, 219, 428  
 Fictitious force elements 27, 29  
 File > Output menu 141, 142, 143, 147  
 File menu 134, 135, 136, 137, 138, 139, 140, 141, 150, 151, 152, 401, 417, 418  
 Find a specified coordinate point in the model 159  
 Flow components 183  
 Flow rules 419, 428, 433, 448, 453  
 Flow toolbar 183  
 Fluid/thermal flow analysis 453  
 Freehand sketching - Model building tutorial 54

## - G -

GIF 141, 142, 150, 401  
 Going to graphics at the current analysis stage 364  
 Going to the model building and editing stage 364  
 Grid lumping 44, 234, 235, 236, 241, 294, 363  
 Grid selection 237, 330, 339  
 Grid spacing 44, 234, 235, 236, 241, 294, 363  
 Ground surface 35  
 Grouping model data 315

## - H -

Help menu 357  
 hidden surface removal 343, 344, 345  
 Hide block colours toolbar 155, 160, 338  
 Hide Cline Colours toolbar 155  
 Hide construction line colours toolbar 155, 160, 338  
 Hide toolbar 152, 160, 338  
 Hiding various parts of the model 152  
 Hoek-Brown in 3D FF Blocks 185, 189, 191, 194, 195, 197, 200, 202, 204, 424  
 Hyperbolic-Backfill in DD Planes 207, 209, 210, 211, 213, 216, 219, 433

## - I -

In situ stress state specification 397, 399  
 Inactive blocks 39  
 Induced strain 178, 233

Induced stress 170, 234  
 Initial stress state specification 397, 399  
 Initialize all viewing parameters 159  
 INP model file format 408, 418  
 In-plane 207, 209, 210, 211, 213, 216, 219  
 In-plane strain 171, 173, 174, 175  
 In-plane stress 164, 165, 166, 167  
 Interpretation of results 16, 23, 376  
 Intersection analysis 365, 368, 369, 382, 454  
 Introduction 2

## - J -

JPEG 141, 142, 150  
 JPG 141, 142, 150

## - L -

Leasing Map3D 2  
 Limitations and shortcomings 16  
 Loading a model from a file 134, 136, 365, 401, 418  
 Loading analysis results from a recently file 152  
 Loading analysis results from a recently used directory 417  
 Loading analysis results from a restart file 139  
 Loading construction line data from a file 137, 138  
 Loading model data from a recently used directory 417  
 Loading model data from a recently used file 152  
 Loading system stiffness calculation 376  
 Local energy release rate calculation 376  
 Lumping and discretization 44, 234, 235, 236, 241, 294, 363

## - M -

Map3D 2, 11, 12, 13, 14, 454, 455  
 Map3D analysis options 258  
 Map3Di 246, 299, 354  
 Material codes 33  
 Material property specification 245, 298, 365, 397, 399, 419, 424, 426, 428, 433, 448, 453  
 Matrix conditioning 44, 234, 235, 241, 294, 363

- Matrix lumping 44, 234, 235, 241, 294, 363
- Matrix solution 366, 367, 383
- Maximum shear strain 171
- Maximum shear stress 163
- Mean stress 168
- Mean value of contour points 249
- Menu Commands - Analysis dialogue box 140, 241, 294, 362, 363, 364, 365, 385, 386
- Menu Commands – Analysis dialogue box 257
- Menu Commands - Analysis Options dialogue box 366, 367, 368, 369, 371, 373, 376, 380, 381, 382, 383, 384
- Menu Commands – Analysis Options dialogue box 258
- Menu Commands - CAD 331, 332, 333, 334
- Menu Commands - CAD > Build 260, 263, 269, 276, 277, 279, 280, 281, 283, 284
- Menu Commands - CAD > Build menu 389, 400
- Menu Commands - CAD > Edit 302, 306, 308, 309, 311, 313, 315, 317, 318, 320, 321, 322, 324, 327, 329
- Menu Commands - CAD > Edit menu 390, 391, 393
- Menu Commands - CAD > Properties 241, 245, 246, 249, 294, 298, 299, 301
- Menu Commands - CAD > Snap 285, 286, 287, 288, 289, 290, 291, 292
- Menu Commands - CAD > Snap menu 390
- Menu Commands - CAD menu 237, 330
- Menu Commands File 137, 138
- Menu Commands - File 134, 135, 136, 137, 139, 140, 141, 150, 151, 152
- Menu Commands - File > Output 141, 142, 143, 147
- Menu Commands - File menu 401, 417, 418
- Menu Commands - Help menu 357
- Menu Commands - Plot 236
- Menu Commands - Plot > Displacement 178
- Menu Commands - Plot > Flow 183
- Menu Commands - Plot > Miscellaneous 235, 236
- Menu Commands - Plot > Properties 241, 245, 249, 294, 298, 301
- Menu Commands - Plot > Strain 170, 171, 173, 174, 175, 176, 177, 178, 180, 233
- Menu Commands - Plot > Strength Factors 185, 189, 191, 194, 195, 197, 200, 202, 204, 207, 209, 210, 211, 213, 216, 219
- Menu Commands - Plot > Stress 162, 163, 164, 165, 166, 167, 168, 169, 170, 180, 234
- Menu Commands - Plot > Surface Components 221, 222, 223, 224, 225, 229, 230, 231, 232, 233, 234, 235
- Menu Commands - Plot menu 473, 475, 476
- Menu Commands – Plot menu 237, 249
- Menu Commands - Seismic 346, 354, 357, 388
- Menu Commands - Tools 160, 335, 336, 337, 338, 339, 340, 341, 342, 343, 344, 345
- Menu Commands – Tools menu
- Menu Commands - ToolsTools menu 343
- Menu Commands - View > Find Coordinate 159
- Menu Commands - View > Hide 152
- Menu Commands - View > Hide Block Colours 155
- Menu Commands - View > Hide Cline Colours 155
- Menu Commands - View > Initialize 159
- Menu Commands - View > Length 160, 338
- Menu Commands - View > Pan 160, 338
- Menu Commands - View > Render 156, 158, 478
- Menu Commands - View > Zoom 160, 338
- Menu Commands - View > Zoom Extents 159
- Menu Commands - View menu 160, 161
- Menu Commands -File menu 401
- Merge adjacent surfaces 369
- Merge coordinate points that are close to one another 368
- Merging model data 401, 418
- Mine design 23
- Mining step selection 141
- Mining step sequence 33
- Model building 13, 27, 29, 30, 33, 35, 36, 39, 54, 76, 96, 246, 260, 263, 269, 276, 277, 279, 299, 302, 306, 308, 309, 311, 313, 315, 317, 318, 320, 321, 322, 324, 327, 329, 331, 364, 368, 369, 382, 383, 389, 390, 391, 393, 400, 401, 418
- Model data 134, 135, 136, 137, 152, 246, 299, 365, 368, 383, 401, 402, 404, 408, 417, 418, 454
- Model orientation icon 479, 480
- Mohr-Coulomb in 3D FF Blocks 185, 189, 191, 194, 195, 197, 200, 202, 204, 419
- Mohr-Coulomb in DD Planes 207, 209, 210, 211, 213, 216, 219, 448
- Moving field points that are very close to boundary surfaces 373

Moving model data 306, 318, 320, 321, 322, 324

## - N -

Numerical Modelling 11, 12, 13, 14, 16, 23

## - O -

OBJ dump of the screen 143

OBJ screen image file format 143

Octahedral shear strain 176

Octahedral shear stress 168

Open pits 35

OpenGL 343, 344, 345

Ore zones 27, 29, 30

Overview of Map3D 11

Overview of model building 13

## - P -

Parametric studies 16

PDF 3D dump of the screen 143

PDF 3D screen image file format 143

Pick box size 346

Plastic strain 178, 233

Plot > Displacement 178

Plot > Flow 183

Plot > Miscellaneous 235, 236

Plot > Properties 241, 245, 249, 294, 298, 301

Plot > Properties menu 245, 298

Plot > Strain 170, 171, 173, 174, 175, 176, 177, 178, 180, 233

Plot > Strength Factors 185, 189, 191, 194, 195, 197, 200, 202, 204, 207, 209, 210, 211, 213, 216, 219

Plot > Stress 162, 163, 164, 165, 166, 167, 168, 169, 170, 180, 234

Plot > Surface Components 221, 222, 223, 224, 225, 229, 230, 231, 232, 233, 234, 235

Plot menu 236, 237, 249, 330, 473, 475, 476

Plot options 237

Plotting surface components during analysis 362, 363

PNG 141, 142, 150, 401

PNT construction line file format 402, 404

PNT dump of analysis results 143, 147

PNT dump of the screen 143, 401

PNT model file format 402, 418

PNT screen image file format 143, 401

Poorly conditioned problems 44, 234, 235, 241, 294, 363

Principal strains 170

Principal stresses 162

Probability 185, 189, 191, 194, 197, 200, 204, 207, 209, 210, 211, 213, 216, 219

Problem size 44, 241, 294, 363

## - R -

RAM for matrix storage 382, 384

Range for plotting contours 236

Recently used directories 417

Recently used files 152

Reliability of modelling predictions 16

Rendering the contours 237

Rendering the model 156, 158

Renumbering surfaces so the volume is positive 383

Reset all viewing parameters 159

Restart files 404, 478

Restarting an analysis 140

Restoring a previously saved view position and contour range 152

Rock mass response predictions 16, 23, 376

Rotating model data 311, 313

Rotating the model 161, 335, 479, 480

Rotation Toolbar 335

Running multiple consecutive analyses 367

## - S -

Sales and support 2

Saving a model to a file 135

Saving a model to a new file name 135, 137

Saving construction line data to a file 139

Saving construction line data to a new file name 139

Saving model data 315

Saving the current view position and contour ranges 152  
Scaling model data 309  
Screen dump 141, 142, 143, 150, 151, 401  
Seismic 346, 354, 357, 388  
Seismic menu 346, 354, 357, 388  
Seismic Moment 249  
Smooth scrolling in the analysis dialogue box 345  
Smoothing construction lines 327, 329  
Snap toolbar 285, 286, 287, 288, 289, 290, 291, 292, 339, 390, 396  
Solution accuracy 44, 234, 235, 236, 241, 294, 363, 380  
Solve toolbar 337, 338  
Special view positions 161  
Steady state thermal/fluid flow analysis 453  
Strain toolbar 170, 171, 173, 174, 175, 176, 177, 178, 180, 233, 475  
Strength criterion 185, 189, 191, 194, 195, 197, 200, 202, 204, 207, 209, 210, 211, 213, 216, 219, 419, 424, 426, 428, 433, 448, 473  
Strength Factors toolbar 185, 189, 191, 194, 195, 197, 200, 202, 204, 207, 209, 210, 211, 213, 216, 219, 473  
Stress Orientation Icon 477  
Stress toolbar 162, 163, 164, 165, 166, 167, 168, 169, 170, 180, 234, 473  
Stretching model data 317  
Subdivide non-planar quadrilaterals into triangles 382  
Subtracting analysis results 140  
Support and sales 2  
Support placement 30, 33, 376, 384  
Surface Components toolbar 221, 222, 223, 224, 225, 229, 230, 232, 233, 234, 235, 476  
Surface Components toolbarr 231  
Surface models 27, 30  
Suspending a Map3D analysis 385

## - T -

Tabular mining - Model building tutorial 96  
Tabular mining zones 36  
Terzaghis Observational Approach 16

Testing disk performance 345  
Thermal/fluid flow analysis 453  
Three-Dimensional excavation shapes 27, 29, 30  
Toolbars 335, 336, 337, 339, 473, 475, 476  
Tools menu 160, 335, 336, 337, 338, 339, 340, 341, 342, 343, 344, 345  
Total strain 178, 233  
Total stress 169  
Translating and zooming the model 477  
Translating the model 160, 335, 336  
Translation toolbar 336  
Tutorial 54, 76, 96

## - U -

Ubiquitous-plane 207, 209, 210, 211, 213, 216, 219  
Ubiquitous-plane strain 171, 173, 174, 175  
Ubiquitous-plane stress 164, 165, 166, 167  
Update results file 140  
User defined button font 342, 343  
User defined colours 340, 341, 342  
User defined contour plots 346, 354, 357, 388  
User defined dump of analysis results 143, 147  
User defined plots 180  
User defined points for stress calculation 373

## - V -

View > Hide Block Colours Menu 155  
View > Hide Cline Colours Menu 155  
View > Hide Menu 152  
View > Render Menu 156, 158, 478  
View menu 159, 160, 161, 338  
View toolbar 155, 160, 338, 339  
Viewing grid planes 237, 330, 339  
Viewing mining steps 141  
VRML dump of the screen 143  
VRML screen image file format 143

## - W -

WRL dump of the screen 143

WRL screen image file format 143

## **- Z -**

z-buffering 343, 344, 345

Zoom so that all entities are visible 159

Zooming the model 161, 335, 336